



OPERATION & SERVICE MANUAL

Model: 01-1102-0010 Learjet Remote Towbar



03/2023 – Rev. 05

**For Spare Parts, Operations & Service Manuals or Service Needs
Scan the QR code or visit [Tronair.com/aftermarket](https://www.tronair.com/aftermarket)**



REVISION	DATE	TEXT AFFECTED
04	03/2007	Major Revision
05	03/2023	Major revision

TABLE OF CONTENTS

PAGE

1.0	PRODUCT INFORMATION	1
1.1	DESCRIPTION.....	1
1.2	MODEL & SERIAL NUMBER.....	1
1.3	MANUFACTURER	1
1.4	SPECIFICATIONS	1
2.0	SAFETY INFORMATION	1
2.1	GENERAL	1
3.0	TRAINING	1
3.1	TRAINING REQUIREMENTS	1
3.2	TRAINING PROGRAM	1
3.3	OPERATOR TRAINING	1
4.0	OPERATION	2
4.1	TOWBAR CHECKLIST	2
4.2	USAGE PROCEDURE	2
4.2.1	Aircraft Attachment.....	2
4.2.2	Tug Attachment.....	2
4.2.3	Couplers.....	3
4.2.4	Towing Operation.....	3
5.0	PROVISION OF SPARES	4
5.1	SOURCE OF SPARE PARTS	4
5.2	RECOMMENDED SPARE PARTS LISTS	4
6.0	IN-SERVICE SUPPORT.....	4
7.0	GUARANTEES/LIMITATION OF LIABILITY	4

Tronair towbars/heads must only be used with matching Tronair heads/towbars, and Tronair shear pins.

This product can not be modified without the written approval of Tronair, Inc. Any modifications done without written approval voids all warranties and releases Tronair, Inc., its suppliers, distributors, employees, or financial institutions from any liability from consequences that may occur. Only Tronair OEM replacement parts shall be used.

1.0 PRODUCT INFORMATION

1.1 DESCRIPTION

The Tronair Model 01-1102-0010 remote towbar is a lightweight towbar for use with Learjet Aircraft.

The remote towbar includes pneumatic tires. There is an eyebolt at the towing end of the towbar which incorporates a spring to dampen shock loads.

1.2 MODEL & SERIAL NUMBER

Reference nameplate on unit

1.3 MANUFACTURER

TRONAIR, Inc.

1 Air Cargo Pkwy East

Swanton, Ohio 43558 USA

Telephone: (419) 866-6301 or 800-426-6301

Fax: (419) 867-0634

E-mail: sales@tronair.com

1.4 SPECIFICATIONS

Application.....Learjet Aircraft
Maximum Aircraft Gross Weight.....23,730 lbs (10.6 Metric ton)
Length139.5 in (354.33 cm) From eyebolt centerline to end of towbar.
Width11.5 in (29.21 cm)
Tube3.5 in (8.9 cm) diameter
Weight83 lbs (37.6 kg)
Finish.....Powder Coat
MaterialAluminum

2.0 SAFETY INFORMATION

2.1 GENERAL

The Tronair Model 01-1102-0010 remote towbar is used for moving Learjet Aircraft only.

To ensure safe operation, please read the following statements and understand their meaning. This manual contains safety precautions which are explained as follows. Please read carefully.



WARNING! Warning is used to indicate the presence of a hazard that can cause **severe personal injury, death, and/or substantial property damage** if the Warning Notice is ignored.

CAUTION! Caution is used to indicate the presence of a hazard which will or can cause **minor personal injury or property damage** if the Caution Notice is ignored.

3.0 TRAINING

3.1 TRAINING REQUIREMENTS

The employer of the operator is responsible for providing a training program sufficient for the safe operation of the towbar.

3.2 TRAINING PROGRAM

The employer provided operator training program should cover safety procedures concerning use of the towbar in and around the aircraft at the servicing location.

3.3 OPERATOR TRAINING

The operator training should provide the required training for safe operation of the towbar.

NOTE: Maintenance and Trouble Shooting are to be performed by the skilled and trained technician.

4.0 OPERATION

4.1 TOWBAR CHECKLIST

- Check towing eye for bending, excessive wear and/or deformity. Contact Tronair for repair/replacement if towing eye is bent, excessively worn or deformed.
- Check towing eye mounting bolts. Ensure fasteners are not loose or missing. Tighten to 25 ft-lbs or replace as required.
- Ensure that the towing eye does not turn; if the towing eye can turn it indicates that the centering pin within the shock assembly may have been broken and repairs are needed.
- Check the shock assembly for preload on the spring by pulling on the towing eye. If the shock can be moved by hand it indicates that the spring is worn out and Tronair should be contacted for repairs.
- Inspect the towbar tube for cracks, gouges greater than 1/16 inch, and bends or deformities. A damaged or bent towbar should not be used. Contact Tronair for replacement.
- Inspect the lifting handle at the towing eye end. Replace or repair the handle if it is missing or damaged. Ensure the mounting fasteners are not loose or missing. Tighten or replace as required.
- Check the towbar undercarriage. Inflate the pneumatic tires to the proper pressure; fix any air leaks or replace if needed, ensure the wheels can rotate freely, wheel rims are not bent, and tire axle is not bent. Ensure mounting fasteners are not loose or missing; tighten or replace as required. Grease the tire axle every 90 days to 6 months.



WARNING!

A damaged or bent towbar should not be used. Towbar should be repaired or replaced.



WARNING!

Tronair recommends the use of a towbar with a category 1 or category 2 tug and aircraft not exceeding 75,000 lbs gross weight. Using the towbar with aircraft weighing in excess of this specific limitation may result in excessive loads and stresses being applied to the towbar and/or the aircraft. These excessive loads may cause failure of the towbar which could cause damage (INCLUDING WITHOUT LIMITATION to the aircraft) and/or personal injury OR DEATH. **TRONAIR MAKES NO REPRESENTATION, WARRANTY OR GUARANTEE AS TO SUCH MISUSE AND DISCLAIMS ANY AND ALL LIABILITY FOR INJURY, LOSS OR DAMAGE ARISING FROM OR RELATING TO SUCH MISUSE.**

4.2 USAGE PROCEDURE

4.2.1 Aircraft Attachment



CAUTION!

It is recommended that your towbar be attached to the aircraft first, and then connected to the tug to avoid possible aircraft damage.

4.2.2 Tug Attachment



CAUTION!

Damage to the towbar or aircraft can result from an excessive towbar angle during towing operations. Reference Figure 1.

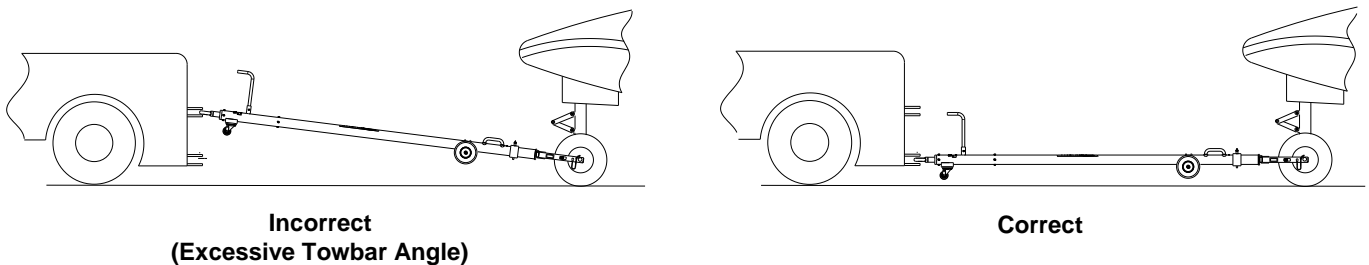

FIGURE 1

- Use a pintle height so that the towbar is as level as possible during towing. Also, the pintle hook height should prevent contact of the towbar with the ground during towing.

4.2.3 Couplers



CAUTION!

Damage to the towbar or aircraft can result while towing with the following types of couplers:

- Lift Head
- Vertical Side Swing Latch
- Standard Duty Latch
- Swivel Hook

The couplers listed above are known to cause binding and failure in the lunette eye. Indicators of binding are wear on outside diameter of the eyebolt and indentation on the inside diameter of the eyebolt. **Reference Figure 2.**

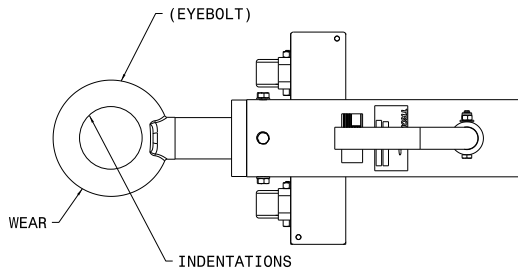

FIGURE 2

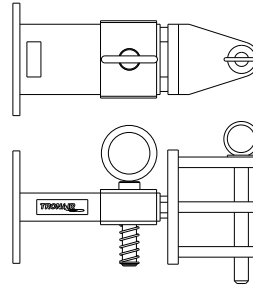

FIGURE 3
01-1950-5000 Standard Telecoupler

Tronair recommends a telecoupler pintle hook arrangement. This arrangement is known to eliminate binding. Tronair offers a Standard Telecoupler, Model Number 01-1950-5000, for use on tugs. **Reference Figure 3.**

Damage to the towbar and/or aircraft can result by towing or pushing an aircraft with an incorrect size eyebolt or pintle pin. A correct size eyebolt will make contact with the pintle pin. A gap between the eyebolt outside diameter and the coupler face plate should be easily seen. An eyebolt which is too large will cause the eyebolt to make contact with the face plate of the coupler. When the eyebolt is too large for the coupler, a gap between the inside diameter of the eyebolt and the coupler face plate will be seen. **Reference Figure 4.**

To ensure proper towing and pushing, check to make sure the pintle pin diameter is not too long for the eyebolt's inside diameter. An approximate one-half inch ($\frac{1}{2}$ ") gap between the pin diameter and the eyebolt should be seen. If any of these conditions are not met, please contact Tronair for information to obtain a new coupler.

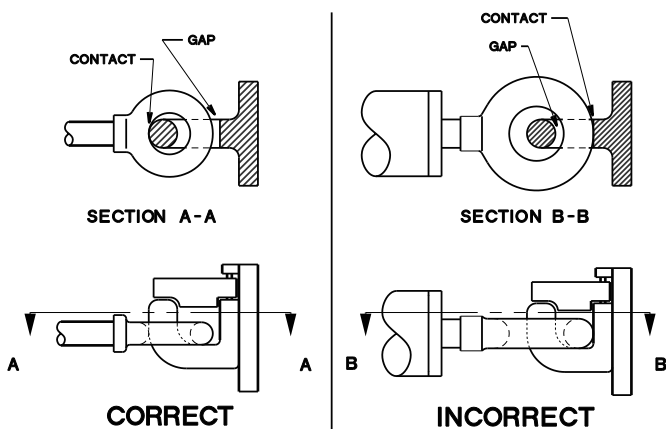

FIGURE 4

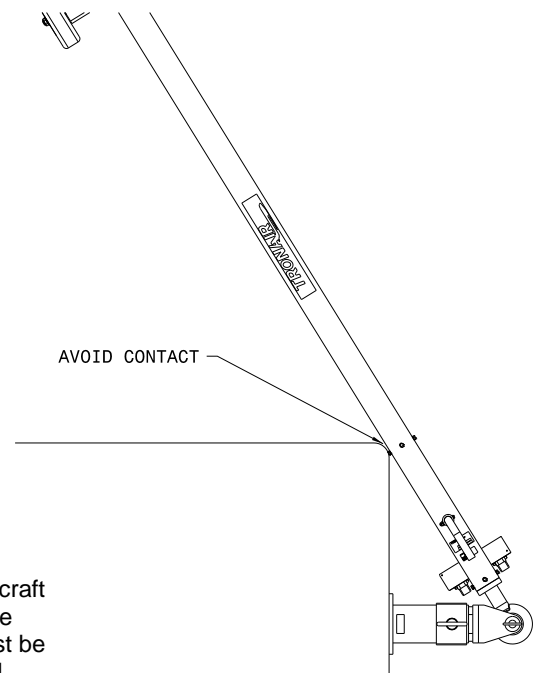

FIGURE 5

4.2.4 Towing Operation

Damage to the towbar or aircraft can result from pushing an aircraft while maintaining too sharp of an angle between the tug and the aircraft. Contact between the towbar weldment and the tug must be avoided. It is recommended that the angle between the tug and towbar not exceed 90°. **Reference Figure 5.**

5.0 PROVISION OF SPARES

5.1 SOURCE OF SPARE PARTS

Spare parts may be obtained from the manufacturer:

TRONAIR , Inc.	Telephone: (419) 866-6301 or 800-426-6301
1 Air Cargo Pkwy East	Fax: (419) 867-0634
Swanton, Ohio 43558 USA	E-mail: sales@tronair.com
	Website: www.tronair.com

For Spare Parts, Operations & Service Manuals or Service Needs:
Scan the QR code or visit Tronair.com/aftermarket



5.2 RECOMMENDED SPARE PARTS LISTS

Reference the following page(s) for Replacement Parts and Kits available.

Recommended Spares to be kept on hand:
K-1112.....Kit, Wheel (Single) Replacement
K-1433.....Kit, Shear Bolt Replacement
K-1565.....Kit, Safety Latch Replacement

6.0 IN-SERVICE SUPPORT

Contact Tronair, Inc. for technical services and information. See Section 1.3 – Manufacturer.

7.0 GUARANTEES/LIMITATION OF LIABILITY

Tronair products are warranted to be free of manufacturing or material defects for a period of one year after shipment to the original customer. This is solely limited to the repair or replacement of defective components. This warranty does not cover the following items:

- a) Parts required for normal maintenance
- b) Parts covered by a component manufacturers warranty
- c) Replacement parts have a 90-day warranty from date of shipment

If you have a problem that may require service, contact Tronair immediately. Do not attempt to repair or disassemble a product without first contacting Tronair, any action may affect warranty coverage. When you contact Tronair be prepared to provide the following information:

- a) Product Model Number
- b) Product Serial Number
- c) Description of the problem

If warranty coverage is approved, either replacement parts will be sent or the product will have to be returned to Tronair for repairs. If the product is to be returned, a Return Material Authorization (RMA) number will be issued for reference purposes on any shipping documents. Failure to obtain a RMA in advance of returning an item will result in a service fee. A decision on the extent of warranty coverage on returned products is reserved pending inspection at Tronair. Any shipments to Tronair must be shipped freight prepaid. Freight costs on shipments to customers will be paid by Tronair on any warranty claims only. Any unauthorized modification of the Tronair products or use of the Tronair products in violation of cautions and warnings in any manual (including updates) or safety bulletins published or delivered by Tronair will immediately void any warranty, express or implied.

The obligations of Tronair expressly stated herein are in lieu of all other warranties or conditions expressed or implied. **Any unauthorized modification of the Tronair products or use of the Tronair products in violations of cautions and warnings in any manual (including updates) or safety bulletins published or delivered by Tronair will immediately void any warranty, express or implied and Tronair disclaims any and all liability for injury (WITHOUT LIMITATION and including DEATH), loss or damage arising from or relating to such misuse.**

Parts List

When ordering replacement parts/kits, please specify model, serial number and color of your unit.

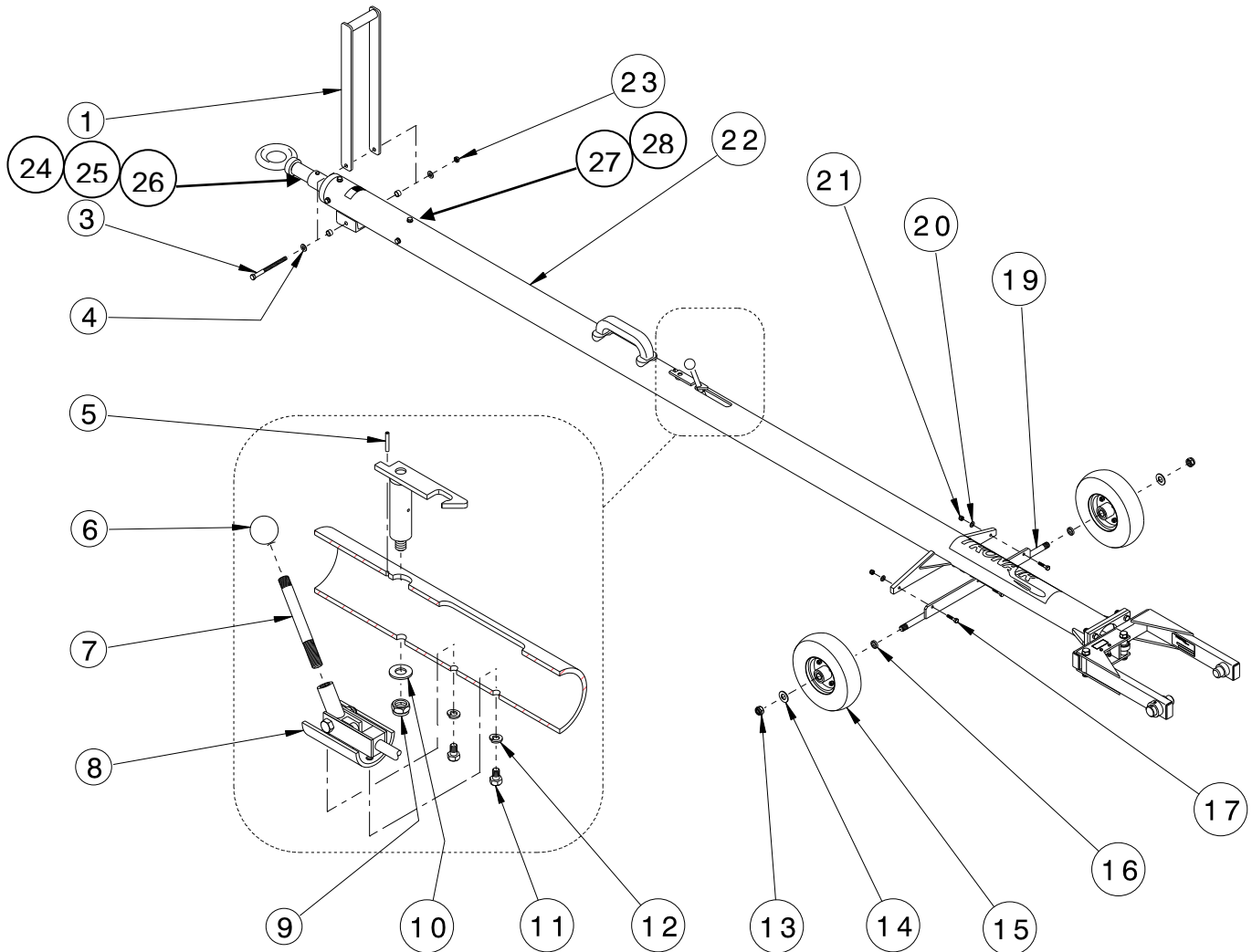

Item	Part Number	Description	Qty
22	Z-1335 (Reference Only)	Towbar Weldment	<i>Not Sold Separately</i>
	K-1112	Kit, Wheel (Single) Replacement; consists of:	
13	G-1203-1105	Jamnut, 5/8-18 Elastic	1
14	G-1250-1100N	Flatwasher, 5/8 Narrow	1
15	U-1024	Wheel	1
	K-1562	Kit, Toggle Linkage Replacement; consists of:	
6	H-1141	Ball, Handle	1
7	R-1025	Handle	1
8	Z-1180-03	Assembly, Toggle Linkage	1
11	G-1100-106504	Bolt, Hex Head, Grade 5, 5/16-24 x 1/2" long	2
12	G-1251-1060R	Lockwasher, 5/16 Regular	2
	K-1565	Kit, Safety Latch Replacement; consists of:	
5	G-1300-16100	Pin, Roll, 5/32" diameter x 1" long	1
9	G-1203-1095	Jamnut, 1/2-20 Elastic	1
10	G-1250-1090N	Flatwasher, 1/2 Narrow	1
Ref	Z-1393	Assembly, Safety Latch	1

Parts List

Item	Part Number	Description	Qty
	K-1603	Kit, Handle Replacement; consists of:	
1	Z-1390-01	Weldment, Handle	1
3	G-1100-107550	Bolt, Hex Head, Grade 5, 3/8-24 x 5" long	1
4	G-1250-1070N	Flatwasher, 3/8 Narrow	2
23	G-1203-1075	Jamnut, 3/8 -24 Elastic	1
Ref	TR378-03*000.38	Spacer	2
	K-2795	Kit, Axle Replacement; consists of:	
13	G-1203-1105	Jamnut, Elastic, 5/8-18	2
14	G-1250-1100N	Flatwasher, 5/8 Narrow	2
16	TR-1583	Spacer, Wheel	2
17	G-1100-105512	Bolt, Hex Head, Grade 5, 1/4-28 x 1 1/4" long	3
19	Z-1443-01	Weldment, Axle Mounting Bracket	1
20	G-1250-1050N	Flatwasher, 1/4 Narrow	6
21	G-1202-1055	Stopnut, 1/4-28 Elastic	3
	K-1433	Kit, Shear Bolt Replacement; consists of:	
25	G-1202-1035	Stopnut, #10-32 Elastic	1
26	G-1110-3-22A	Bolt, Shear	1
	K-1434	Kit, Shock Assembly Replacement; consists of:	
24	Z-1456-01	Assembly, Shock	1
27	G-1420-106006	Bolt, Hex Head, Grade 8, 5/16-18 x 3/4" long	8
28	G-1251-1060R	Lockwasher, 5/16 Regular	8

Parts List

When ordering replacement parts/kits, please specify model, serial number and color of your unit.

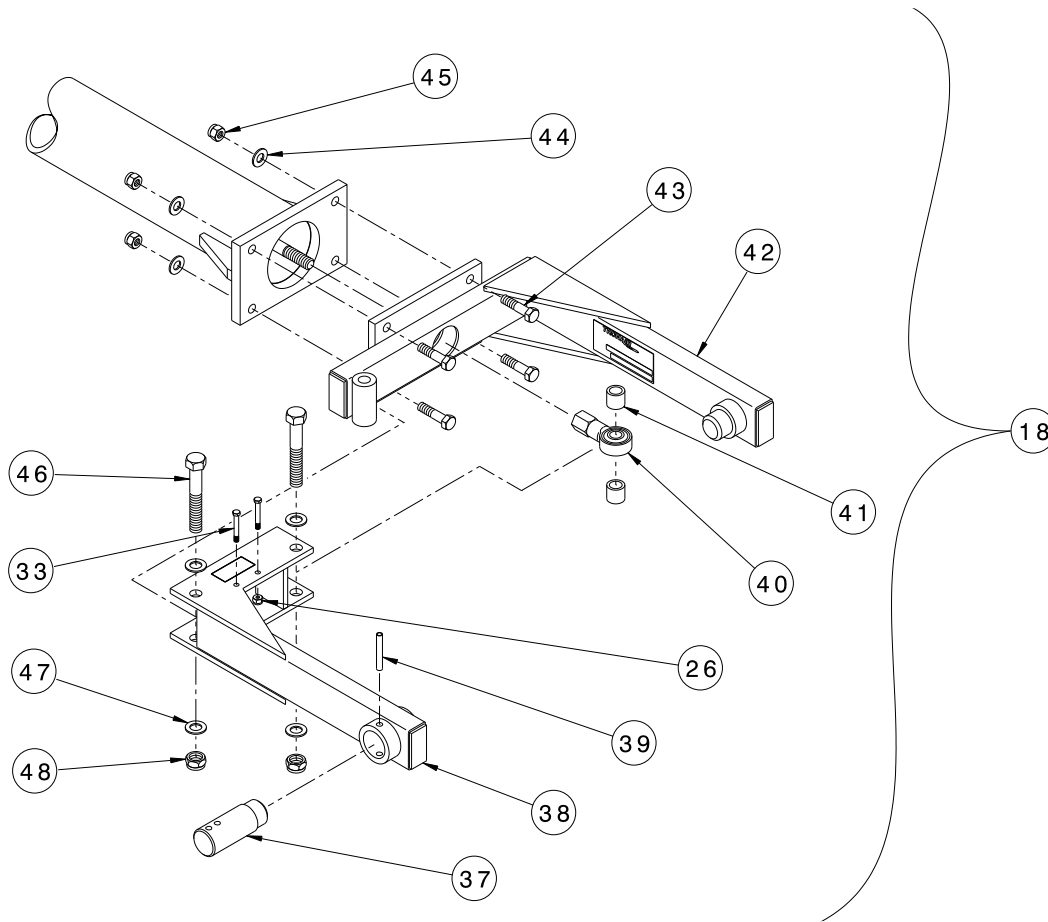

Item	Part Number	Description	Qty
26	G-1202-1035	Stopnut, #10-32 Elastic	1
33	G-1110-3-22A	Bolt, Shear	1
	K-1613	Kit, Movable Arm Replacement; consists of:	
38	Z-4055-01	Weldment, Movable Arm	1
40	H-1140-07	Rod End, Female	1
41	TR-1040-01	Spacer	2
46	G-1100-109532	Bolt, Hex Head, Grade 5, ½-20 x 3 ¼" long	2
47	G-1250-1090N	Flatwasher, ½ Narrow	4
48	G-1203-1095	Jamnut, ½-20 Elastic	2
	K-1567	Kit, Head Assembly Replacement; consists of:	
40	H-1104-07	Rod End, Female	1
41	TR-1040-01	Spacer	2
43	G-1100-107514	Bolt, Hex Head, Grade 5, 3/8-24 x 1 ½" long	4
44	G-1250-1070N	Flatwasher, 3/8 Narrow	4
45	G-1202-1075	Stopnut, 3/8-24 Elastic	4
18	X-1003	Assembly, Head with Label; consist of:	1
37	R-1076	Pin, Movable	1
39	G-1300-25160	Pin, Roll, ¼" diameter x 1 ¾" long	1
42	Z-1338-01	Weldment, Remote Head	1
46	G-1100-109532	Bolt, Hex Head, Grade 5, ½-20 x 3 ¼" long	2
47	G-1250-1090N	Flatwasher, ½ Narrow	4
48	G-1203-1095	Jamnut, ½-20 Elastic	2



APPENDIX I

Declaration of Conformity



DECLARATION of CONFORMITY

The design, development and manufacture is in accordance with European Community guidelines

Remote Towbar
01-1102-0010

Relevant provisions complied with by the machinery:
2006/42/EC

Relevant standards complied with by the machinery:
EN ISO 12100-1

Identification of person empowered to sign on behalf of the Manufacturer:

A handwritten signature in black ink that reads "Patrick Finch". The signature is written in a cursive style and is positioned above a horizontal line.

Quality Assurance Representative



Remote Linkage Towbars

Models:

01-1101-0000, 01-1102-0000, 01-1102-0010,
01-1127-0000, 01-1210-0000, 01-1210-0010

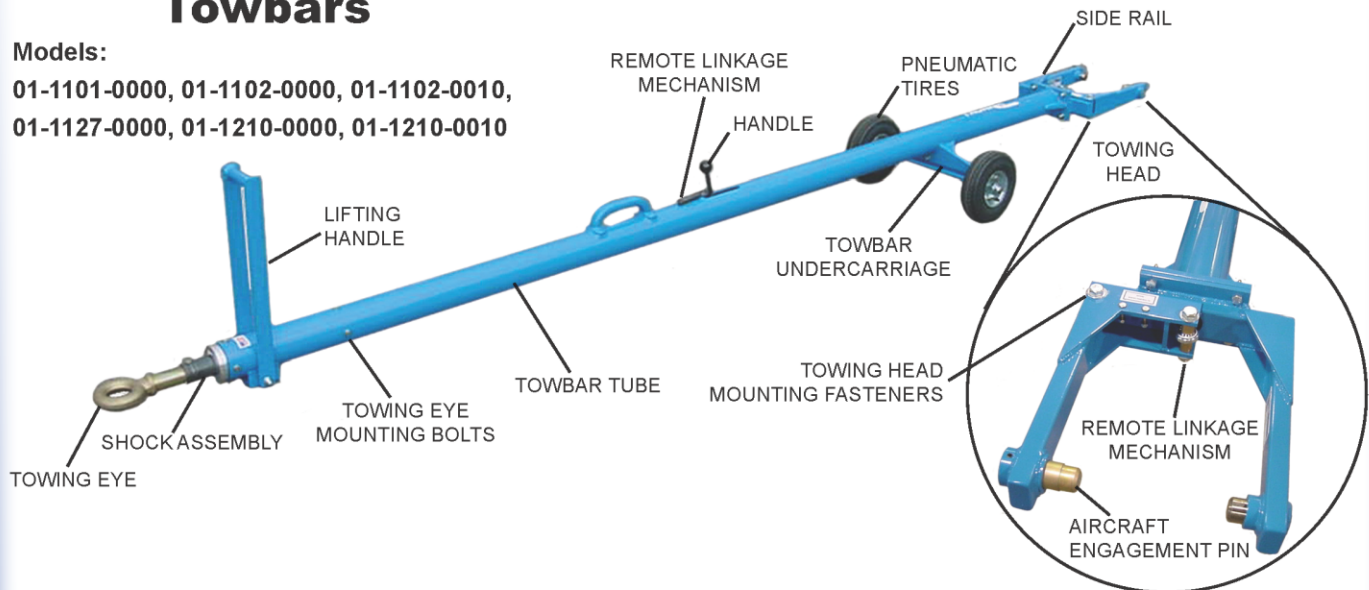

Tronair recommends towbar inspections at least once a week.

- Check towing eye for bending, excessive wear and deformity. If any are located, remove towbar from service and contact Tronair for repair.
- Check towing eye mounting bolts. Ensure the fasteners are tight and not missing. Tighten to 25 ft-lbs or replace as required.
- Ensure the towing eye does not move or turn by hand; if the towing eye can turn this may indicate that the centering pin within the shock assembly may be broken, contact Tronair for repairs.
- Check the shock assembly for preload on the spring by pulling on the towing eye. If the shock can be moved by hand this may indicate the spring is worn out, contact Tronair for repairs.
- Inspect the towbar tube for cracks, gouges greater than 1/16", and bends or deformities. If any are located, remove towbar from service and contact Tronair for repair.
- Inspect the lifting handle for damage. Contact Tronair if repairs are needed.
- Inspect the remote linkage mechanism to insure it operates without binding. Ensure the handle locks into place when the head is in the closed position. If the remote linkage mechanism does bind and/or the handle does not lock into place, check the mechanism's mounting fasteners to ensure they are tight and not missing. Tighten or replace as required. Inspect all components for damage, contact Tronair or your Tronair distributor for replacement.
- Check the towbar undercarriage for unusual wear or damage. Inflate the pneumatic tires to the proper pressure; repair any air leaks or replace if needed. Ensure the wheels can rotate freely, and wheel rims and tire axle are not bent. Ensure mounting fasteners are tight and not missing. Tighten or replace as required. Grease tire axle every 90 days.
- Ensure the towing head mounting fasteners are tight and not missing. Tighten or replace as required.
- Inspect towing head side rails for bending or damage. If any are located, remove towbar from service and contact Tronair for repair.
- Inspect the aircraft engagement pins for bending or excessive wear. If any are located, remove towbar from service and contact Tronair for repair.
- Inspect all steel components for signs of rust. Touch up with paint as required.

INS-1788

www.tronair.com

Tronair • Email: sales@tronair.com • Phone: 419-866-6301 or 800-426-6301 • Fax: 419-867-0634

Asia Sales Offices: China - Email: tronairchina@tronair.com • Phone: 86-592-5560735 • Fax: 86-592-5563132

Asia/Australia - Email: tronairasia@tronair.com • Phone: 66-2665-6511 • Fax: 66-2204-1858

Europe, Middle East & Africa Sales Office • Email: saleseurope@tronair.com • Phone: 44-0-113-245-3300 • Fax: 44-0-113-322-0436