



**Model: 08-0149C4000
Engine Sling**



02/2013 – Rev. 02

When ordering Replacement Parts/Kits, please specify Model, Color and Serial Number of your Unit.

REVISION

01
02

DATE

02/2012
02/2013

TEXT AFFECTED

Original release
Major revision

TABLE OF CONTENTS

PAGE

1.0	DESCRIPTION.....	Error! Bookmark not defined.
2.0	SPECIFICATIONS	Error! Bookmark not defined.
3.0	SAFETY	1
4.0	ENGINE HANGING INSTRUCTIONS.....	2
5.0	INSPECTION	3
6.0	LOAD TEST	3

This product can not be modified without the written approval of Tronair, Inc. Any modifications done without written approval voids all warranties and releases Tronair, Inc., its suppliers, distributors, employees, or financial institutions from any liability from consequences that may occur. Only Tronair OEM replacement parts shall be used.

For Lear 85 engine. To be used with 08-2037-0000 engine installation tool.

1.0 PRODUCT INFORMATION

1.1 DESCRIPTION

The Tronair 08-2037-0000 Engine Sling is designed for the Pratt-Whitney PW615F engines. Always follow manufacturer's instructions for proper engine handling.

1.2 MODEL & SERIAL NUMBER

Reference nameplate on unit

1.3 MANUFACTURER

TRONAIR, Inc.
1 Air Cargo Pkwy East
Swanton, Ohio 43558

Telephone: (419) 866-6301 or 800-426-6301
E-mail: sales@tronair.com
Website: www.tronair.com

1.4 SPECIFICATIONS

Sling Weight: 58 lbs.
Capacity: 2000 lbs.
Length: 55-1/2"
Width: 35-1/8"
Height: 50-13/16"
Finish: Plated

2.0 SAFETY

Safety instructions specifically pertaining to this unit appear throughout this manual highlighted by the signal words



WARNING! — Warning is used to indicate the presence of a hazard that **can cause severe personal injury, death, or substantial property damage** if the warning notice is ignored.

CAUTION! — Caution is used to indicate the presence of a hazard that **will or can cause minor personal injury or property damage** if the caution notice is ignored.



WARNING!

- NEVER exceed rated load or lift a load not intended for this sling.
- NEVER use sling if any damage or excessive wear is found.
- NEVER lift suspended loads over personnel.
- NEVER make any alterations or modifications to sling.
- ALWAYS stay clear of suspended loads.



CAUTION!

Ensure engine is balanced on sling. If engine is unbalanced, check that the orientation of sling is correct. In the event of an unbalanced condition, loss of control and/or damage may occur to the engine along with injury to operator.

- NEVER use sling to lift personnel.
- NEVER leave suspended loads unattended.
- NEVER remove or obscure warning labels.
- DO NOT use sling until you have read and understood this manual.
- NEVER lift loads higher than necessary.

3.0 TRAINING

3.1 TRAINING REQUIREMENTS

The employer of the operator is responsible for providing a training program sufficient for the safe operation of the unit.

3.2 TRAINING PROGRAM

The employer provided operator training program should cover safety procedures concerning use of the unit in and around the intended aircraft at the intended aircraft servicing location.

3.0 TRAINING (continued)

3.3 OPERATOR TRAINING

The operator training should provide the required training for safe operation of the unit.

NOTE: Maintenance and Trouble Shooting are to be performed by a skilled and trained technician.

4.0 ENGINE HANGING INSTRUCTIONS

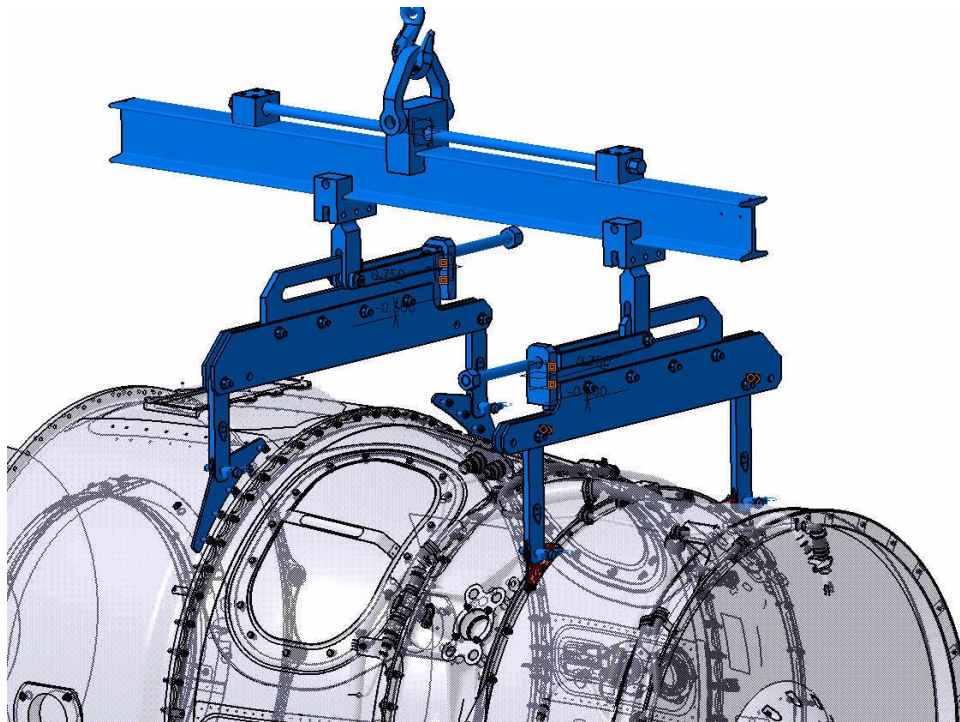

5.0 INSPECTION

SERVICE	INTERVAL	
Normal	Yearly	Inspect equipment at site of use. Operation with various weights within the rated load limit, or uniform loads less than 65 percent of rated load.
Heavy	Semi-Annual	Inspect equipment at site of use unless external conditions indicate that disassembly should be done to permit detailed inspection. Operation within the rated load limit that exceeds normal service.
Severe	Quarterly	Inspect equipment at site of use unless external conditions indicate that disassembly should be done to permit detailed inspection. Operation at normal or heavy service under abnormal operating conditions.
Special/ Infrequent	As recommended by a qualified person before the first such use and as directed by the qualified person for any subsequent uses	

This sling needs to be inspected per the following:

1. Every Lift Inspection (preformed visually by operator):
 - a. Missing parts (pins, fasteners, labels, etc).
 - b. Operation of all ball-lok pins & shackles.
 - c. Inspect sling components for any signs of material deformation, cracks, or excessive wear.
2. Frequent & Periodic Inspections (performed by designated personnel):
 - a. Visual (performed monthly): same as 5.1 Every Lift Inspection
 - b. Record (Semi-Annually):
 - I. Loose bolts and fasteners
 - II. Cracked or excessively worn straps, bars & plates
 - III. Excessive wear at hoist points and load support clevis & pins.

6.0 LOAD TEST

It is recommended to send Equipment to Manufacturer or Authorized Service Center for Recertification.

Rated load at engine sling lift hole: 2000 lbs.

The rated capacity shall not be more than 80 percent of the maximum load sustained during the test. Test loads shall not be more than 125 percent of the rated capacity unless otherwise recommended by the manufacturer. Test weights shall be accurate to within -5 percent, +0 percent of stipulated values.

Annual Sling Assembly Load Test

1. Measure strap lengths and record
2. Install strap into a fixture
 3. Load test sling to 125% of rated load
- 4.
5. Apply 1 ½ times the load indicated on the strap and hold for approximately one (1) minute.
6. Remove straps from fixture and inspect the entire component for any signs of failure, i.e., broken or cracked welds, elongated holes, or cracks in any other portion of the component.
 - a. Any item which does not successfully pass the test is to be rejected and discarded or returned to Tronair for evaluation.
 - b. Re-measure strap length and record. If length of strap after testing is greater than length before testing call Tronair with results before using the assembly again.
 - c. Any surface defects, greater than 10% of material thickness, should be returned to Tronair for evaluation.

Parts List

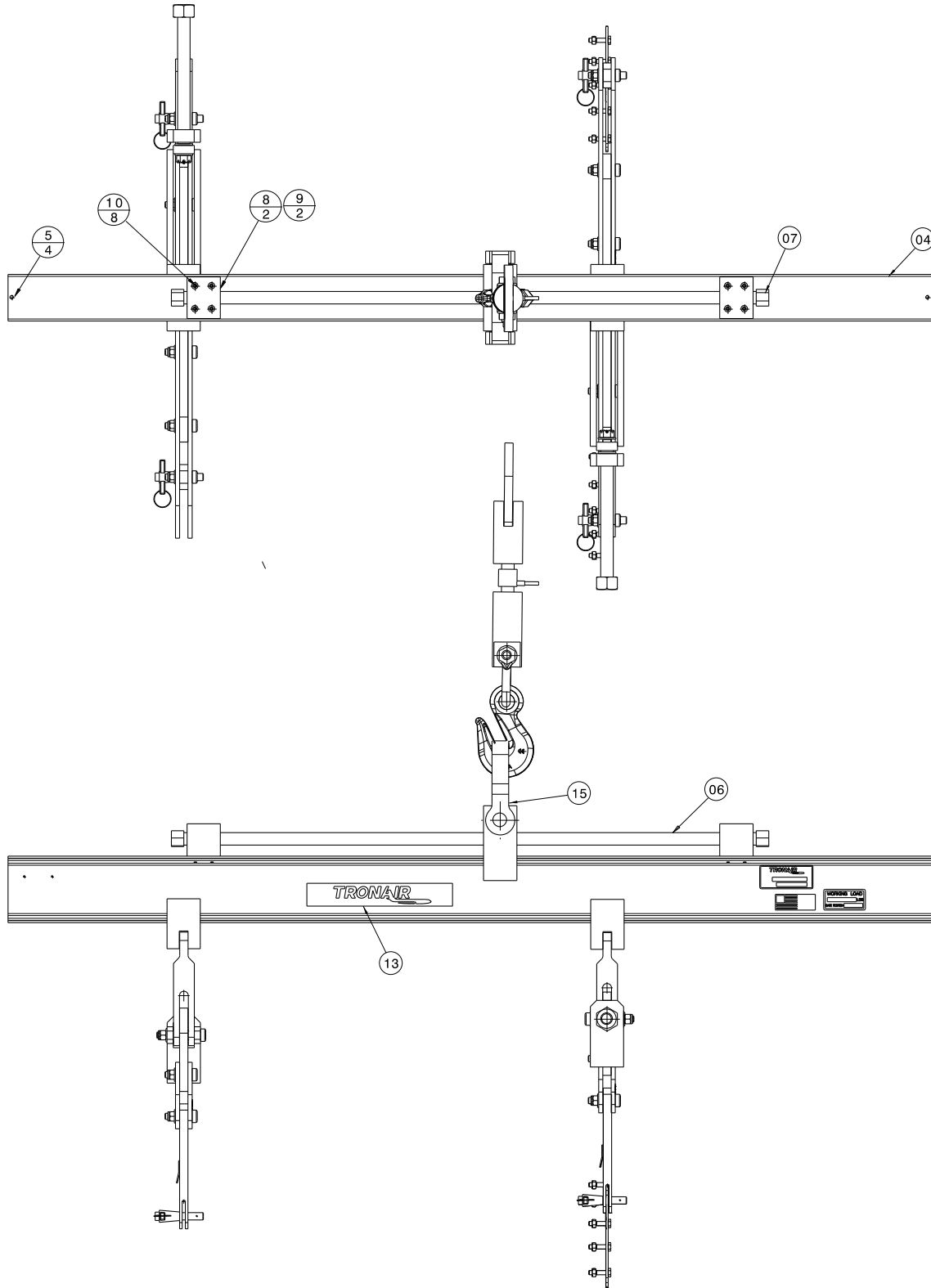

Parts List

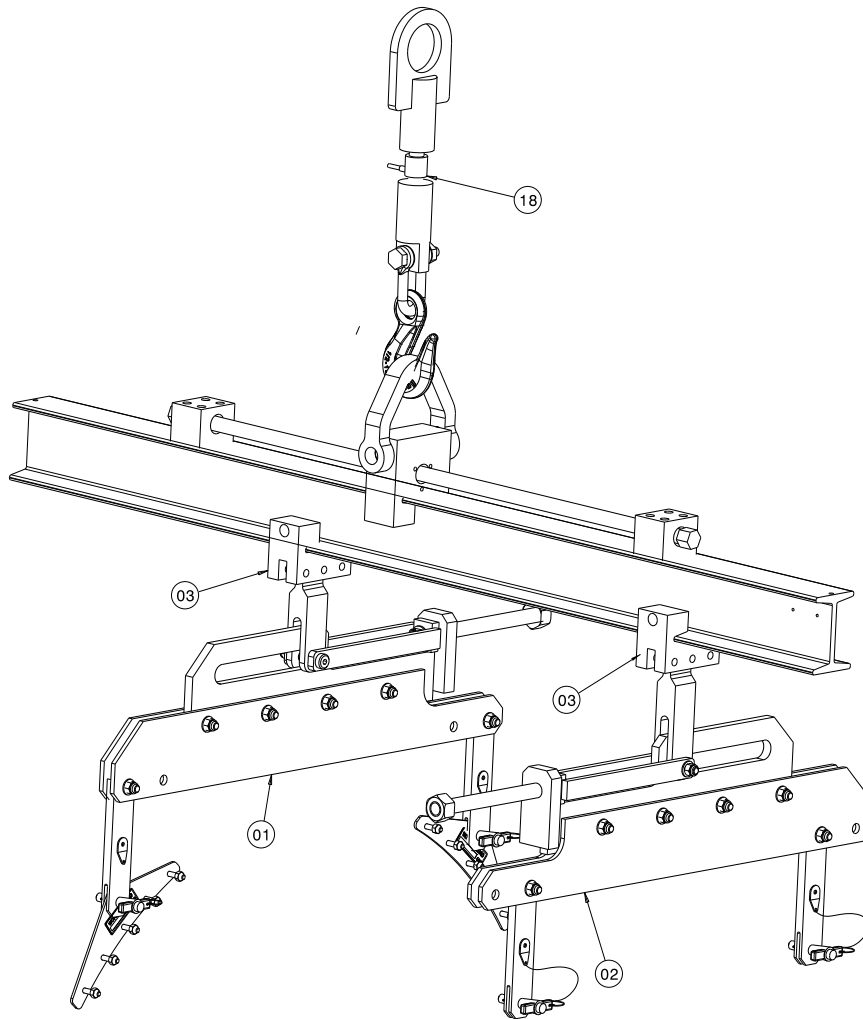

ITEM	PART NUMBER	DESCRIPTION	QTY
1	Z-7670	Assembly, Rear Mount	1
2	Z-7672	Assembly, Front Mount	1
3	Z-3640	Assembly, Slide Block	2
4	M-1145	I-Beam, Sling	1
5	G-1151-105203	Screw, SOC HD CAP, 1/4 - 20 x 3/8 Long	4
6	Z-3525	Assembly, Acme Rod	1
7	G-1300-13100	Pin, Roll, 1/8 x 1 Long	1
8	J-2577	Block, Guide	2
9	H-2019-61	Bearing, Flange	2
10	G-1151-105220	Screw, SOC HD CAP, 1/4 - 20 x 2 Long	8
11	V-1725	Label, Working Load	1
12	V-1779	Label, Serial CE Non-Elect	1
13	V-1002	Label, Tronair	2
14	V-1001	Label, Made In USA	1
15	Z-3517	Assembly, Clevis Block	1
18	Z-7693	Assembly, Load Cell	1

Parts List – Z-7672

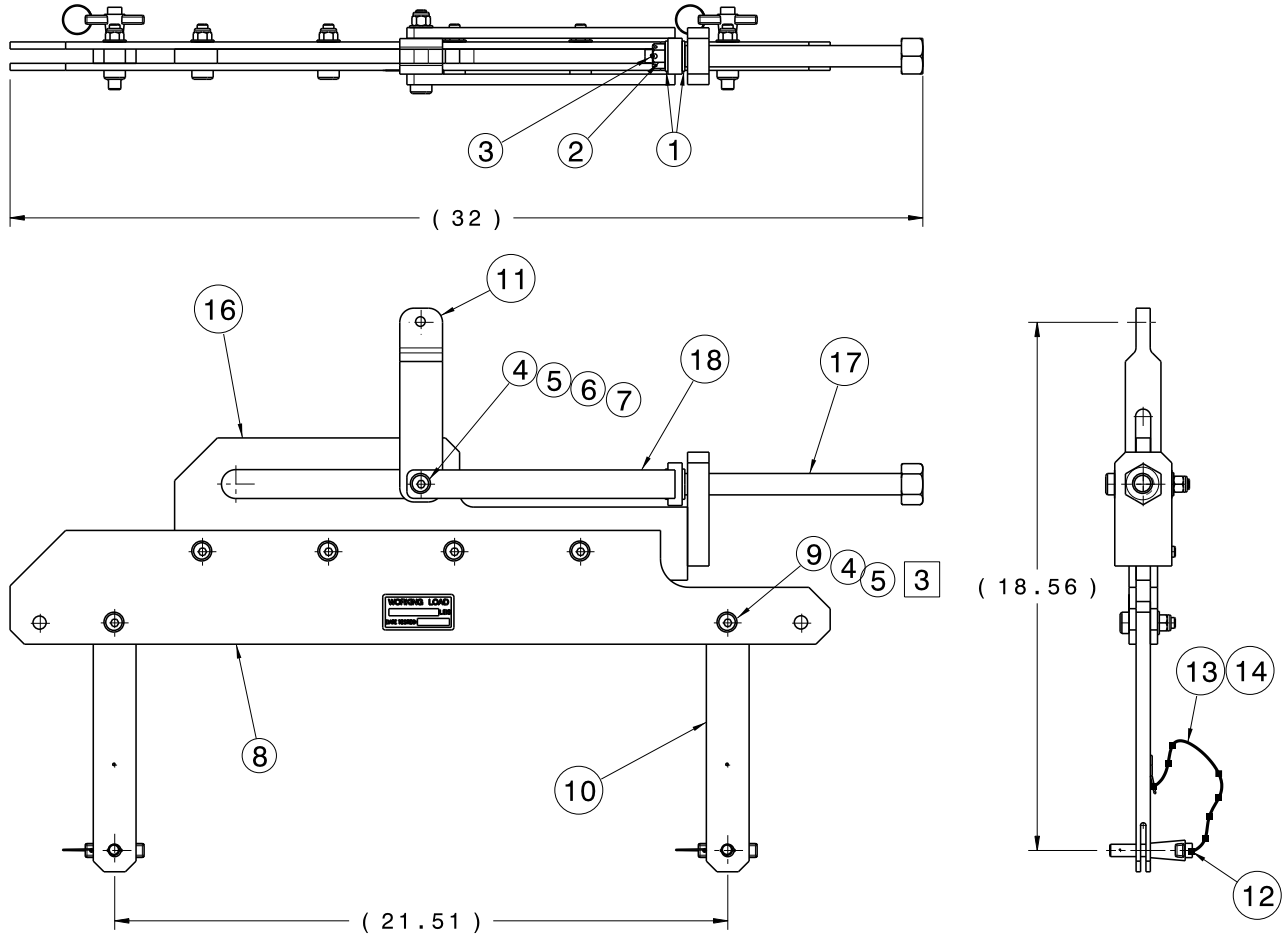

ITEM	PART NUMBER	DESCRIPTION	QTY
1.....	G-1250-1090N.....	Flatwasher, ½ Narrow	2
2.....	G-1464-10	Nut, ½ - 20 STD Slotted Hex.....	1
3.....	G-1303-13060	Pin, ½ - ¾ LG SST Roll	1
4.....	G-1250-1070N.....	Flatwasher, ¾ Narrow	7
5.....	G-1202-1070	ESN, ¾ - 16.....	7
6.....	G-1155-107220	Screw, ½ SOC HD SHLDER.....	1
7.....	H-1725-12.....	Bushing, Headless Press Fit	1
8.....	J-4961	Plate, Adapting PW 307B.....	2
9.....	G-1155-107210	Screw, ½ x 1 SOC HD SHLDER	6
10.....	J-5389	Strap, Front Mount	2
11.....	J-4964	Strap, Hanger.....	1
12.....	G-1310-0710	Pin, T-Handle Ball Lock.....	2
13.....	H-1026*07.0	Assembly, Cable	2
14.....	G-1351-06	Rivet, ½ Open End Steel.....	2
16.....	Z-6101	Weldment, Side Plate.....	1
17.....	Z-3515	Weldment, Rotation Screw.....	1
18.....	Z-3516.....	Weldment, Rotation Arm	1

Parts List – Z-7670

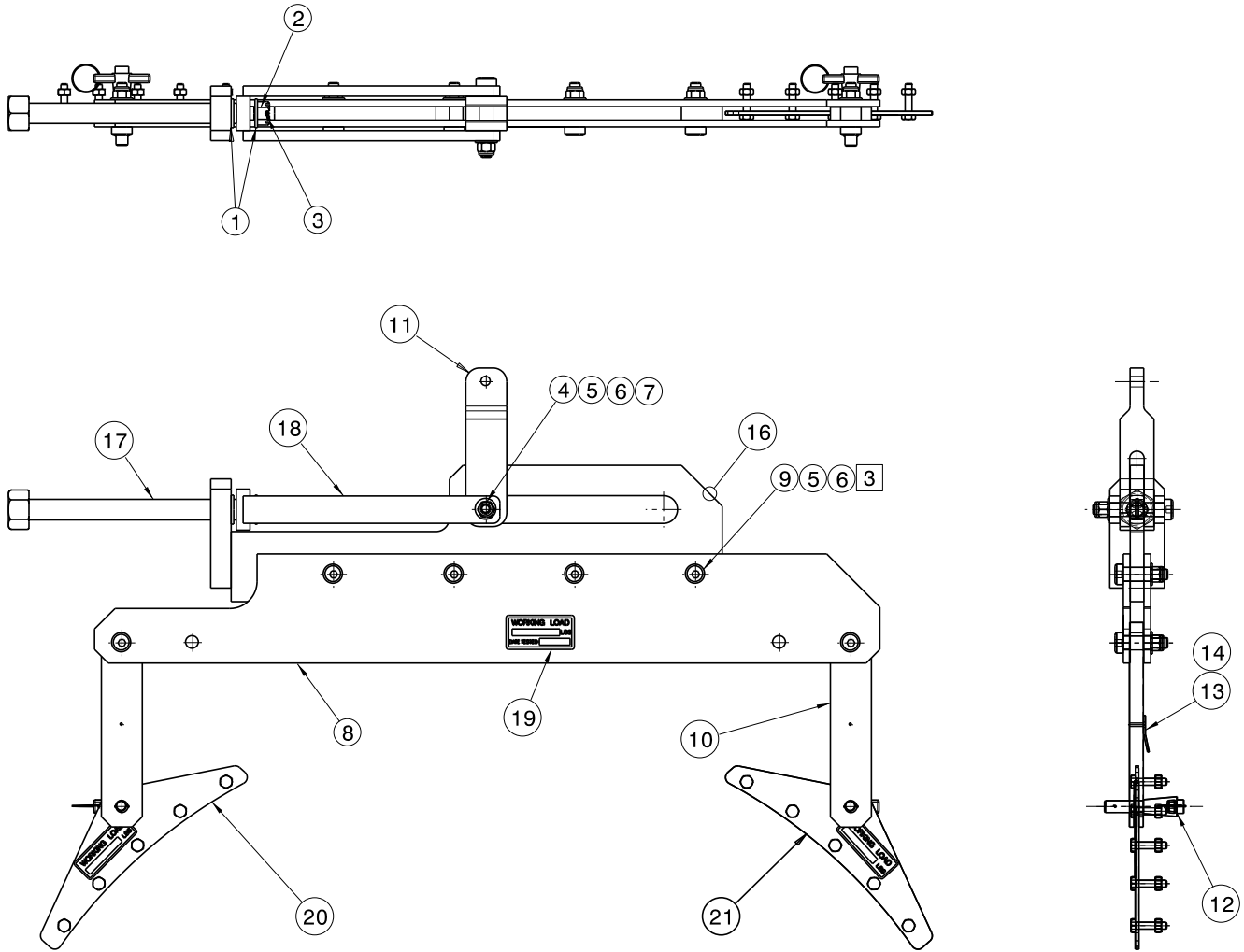

ITEM	PART NUMBER	DESCRIPTION	QTY
1	G-1250-1090N	Flatwasher, ½ Narrow	2
2	G-1464-10	Nut, ½ - 20 STD Slotted Hex	1
3	G-1303-13060	Pin, ⅙ - ¾ LG SST Roll	1
4	G-1250-1070N	Flatwasher, ⅜ Narrow	7
5	G-1202-1070	ESN, ⅜ - 16	7
6	G-1155-107220	Screw, ½ SOC HD SHLDER	1
7	H-1725-12	Bushing, Headless Press Fit	1
8	J-4961	Plate, Adapting PW 307B	2
9	G-1155-107210	Screw, ½ x 1 SOC HD SHLDER	6
10	J-3719	Strap, Front Mount	2
11	J-4964	Strap, Hanger	1
12	G-1310-0710	Pin, T-Handle Ball Lock	2
13	H-1026*07.0	Assembly, Cable	2
14	G-1351-06	Rivet, ⅙ Open End Steel	2
16	Z-6101	Weldment, Side Plate	1
17	Z-3515	Weldment, Rotation Screw	1
18	Z-3516	Weldment, Rotation Arm	1
19	V-1725	Label, Working Load	1
20	Z-7778-01	Bracket, Rear Lift	1
21	Z-7778-02	Bracket, Rear Lift	1

Parts List

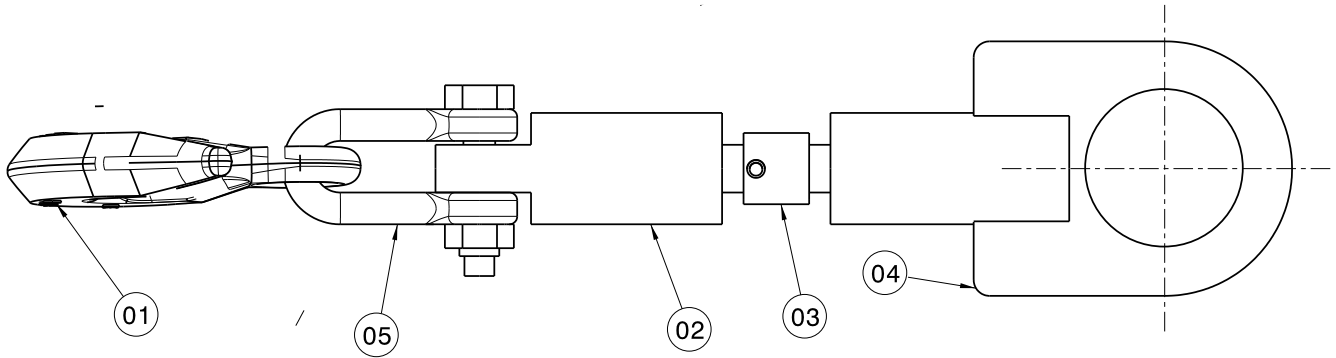

ITEM	PART NUMBER	DESCRIPTION	QTY
1.....	H-2643.....	Hook.....	1
2.....	R-2624-01.....	Attachment, Load Cell.....	1
3.....	H-3456.....	Load Cell.....	1
4.....	Z-7705-01.....	Weldment, Strain Gauge.....	1
5.....	H-2646.....	Shackle, 2 Ton.....	1
Not Shown.....	H-3489.....	Display, Digital Load Cell.....	1
Not Shown.....	H-3490.....	Cable Outlet, Male Plug.....	1



APPENDIX I

**Declaration
of
Conformity**



DECLARATION of CONFORMITY

The design, development and manufacture is in accordance with European Community guidelines

ENGINE SLING

Relevant provisions complied with by the machinery:
EN ISO 12100-1

Relevant standards complied with by the machinery:
EN ISO 12100-1
EN 1915-1:2001 (5.20)

Identification of person empowered to sign on behalf of the Manufacturer:

A handwritten signature in cursive script that reads "Patrick Finch". The signature is written in black ink and is positioned above a horizontal line.

Quality Assurance Representative



APPENDIX II

IHH500

Intelligent Digital Handheld Display

Quick Start Guide and User's Guide

IHH500 Quick Start Guide



FUTEK
ADVANCED SENSOR TECHNOLOGY, INC.

10 Thomas, Irvine, CA 92618, USA

Toll Free: (800) 23-FUTEK

Telephone: (949) 465-0900

Fax: (949) 465-0905

futek@futek.com

www.futek.com

Table of Contents

Overview..... - 3 -
Creating a sensor profile..... - 4 -
Release Information..... - 7 -
Copyright..... - 7 -
Disclaimer..... - 7 -
Contact Information - 7 -

Overview

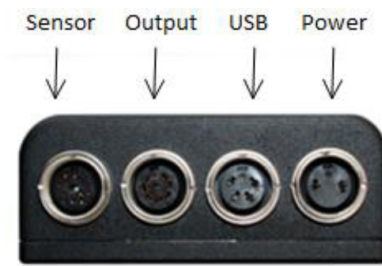

Note:

The IHH500 is set to recognize TEDS automatically upon startup if this function is available. This function must be enabled under the TEDS DATA menu. For more information on TEDS see section 6.8 of the IHH500 manual.

More information on setting up and editing a sensor profile can be found in section 6.1 of the IHH500 manual.

Sensor Wiring Diagram:

Connectors	Description	Diagram (Female Insert)	
Sensor connections	Pin A: +E	+Excitation	
	Pin B: +S	+Signal	
	Pin C: -E	-Excitation, TEDS return	
	Pin D: -S	-Signal	
	Pin E: TEDS_IO	TEDS Data	
	Pin F: 24_OUT	24V output	
	Pin G: GND_OUT	Ground	
	Pin H: 5_OUT	5V Output	
	Pin J: -V	-V from sensor	
	Pin K: +V	+V from sensor	
	Pin L: Leading Pulse	From sensor	
	Pin M: Lagging Pulse	From sensor	

Creating a sensor profile

- 1.) Connect the sensor cable to the IHH500 sensor port and turn on the IHH500 by pressing the POWER button in the lower right corner.
 - a) During the power up of the IHH500 an internal auto calibration will be performed.
 - b) Next, a screen showing the current selected channel, serial number, sensor type, and sensor sensitivity will briefly be displayed.
 - c) The normal operating screen will now be displayed with the updated peak, tracking, valley, selected channel, gross/tare mode, and sampling rate (samples per second).
- 2.) Press the red MENU button to enter into the IHH500 main menu.
 - a) The menu mode is controlled by the red arrow keys and red command words.
- 3.) Using the red Enter button select SENSOR PROFILE.
- 4.) Using the red down arrow key followed by the red Enter button select NEW CHANNEL.
- 5.) Using the red left and right arrow keys followed by the red Enter button set the number for the sensor channel to be created.
 - a.) Channel 01 is a calibrated reference channel, set in the IHH500 at the factory, and cannot be overwritten or selected during a sensor profile setup.
- 6.) Using the red Enter button select SENSOR CONFIGURATION.
 - a) Each step in this menu must be completed before moving on to the next step.
- 7.) Using the red left and right arrow keys followed by the red Enter button set the sensor type.
 - a) Sensor type is usually listed on the sensor calibration certificate by output and can be:
 - FULL BRIDGE for mV/V output sensors.
 - BRIDGE & PULSE for mV/V output sensors with encoder.
 - VOLTAGE OUTPUT for amplified voltage output sensors.
 - VOLTAGE & PULSE for amplified voltage output sensors with encoder.
 - CURRENT OUTPUT for amplified current output sensors.
 - CURRENT & PULSE for amplified current output sensors with encoder.

*For more information on sensor type see section 6.1.3.1 of the IHH500 manual.
- 8.) Using the red down arrow key followed by the red Enter button select DIRECTION.
- 9.) Using the red left and right arrow keys followed by the red Enter button set the sensor direction type.
 - a) UNI-DIRECTION is used for sensors with one direction of output such as compression only.
 - b) BI-DIRECTION is used for sensors with two directions of output such as compression and tension.

*For more information on sensor direction see section 6.1.3.2 of the IHH500 manual.
- 10.) Using the red down arrow key followed by the red Enter button select UNIT SELECTION.
- 11.) Using the red up and down arrow keys followed by the red Enter button select the type of output to be measured by the sensor.

- 12.) Using the red left and right arrow keys followed by the red Enter button select the engineering units to correspond with the measured output of the sensor.
- *For more information on selectable engineering units see section 6.1.3.3.1 of the IHH500 manual.
- 13.) Using the red down arrow key followed by the red Enter button select SENSOR CAPACITY.
- 14.) Using the red left and red right arrow keys select the digit to be changed. Using the red up and down arrow keys set the value for the selected digit that corresponds to the sensors full capacity. Use the red ENTER button to save the value.
- The decimal place can be set by first changing the decimal to a number and then changing another selected digit into a decimal.
 - The sensor's full capacity is usually listed on the sensor calibration certificate.
- 15.) Setup SENSITIVITY (+)
- Using the red down arrow key followed by the red Enter button select SENSITIVITY (+).
 - The sensitivity (+) will be the positive mV/V output for bridge type sensors and the maximum positive voltage output for amplified sensors.
 - The output of the sensor is usually listed on the sensor calibration certificate.
 - For current output sensors, +/- Sensitivity is not available. CALIBRATION must be used for current output sensors. See step 19 below.
 - *For more information on sensitivity see section 6.1.3.5 of the IHH500 manual.
 - Using the red left and red right arrow keys select the digit to be changed. Using the red up and red down arrow keys set the value for the selected digit that corresponds to the sensors sensitivity (+) and use the red ENTER button to save the value.
 - The decimal place can be set by first changing the decimal to a number and then changing another selected digit into a decimal.
- 16.) Setup SENSITIVITY (-)
- Using the red down arrow key followed by the red Enter button select SENSITIVITY (-).
 - SENSITIVITY (-) can only be selected if BI- DIRECTIONAL was selected earlier.
 - The sensitivity (-) will be the negative mV/V output for bridge type sensors and the maximum negative voltage output for amplified sensors.
 - The output of the sensor is usually listed on the sensor calibration certificate.
 - For current output sensors, +/- Sensitivity is not available. Calibration must be used for current output sensors.
 - Using the red left and red right arrow keys select the digit to be changed. Using the red up and red down arrow keys set the value for the selected digit that corresponds to the sensors sensitivity (-) and use the red ENTER button to save the value.
 - The decimal place can be set by first changing the decimal to a number and then changing another selected digit into a decimal.
- 17.) Using the red down arrow key followed by the red Enter button select CALIBRATION if a live calibration, where a load is to be placed on the sensor, is desired. Otherwise, CALIBRATION can be skipped by pressing the red down arrow key.
- Press the red Enter button to select Zero load (+) and proceed to the input screen.

- b.) With no load on the sensor, press the red Enter button to capture the Zero load (+) reading.
 - c.) Press the red down arrow key followed by the red Enter button to select FullScale (+) and proceed to the input screen.
 - d.) With the full load on the sensor, which results in the full positive output, press the red Enter button to capture the FullScale (+) reading.
 - e.) Press the red down arrow key followed by the red Enter button to select Zero load (-) and proceed to the input screen.
 - The direction must be set to Bi-Directional for a – input in CALIBRATION.
 - f.) With no load on the sensor, press the red Enter button to capture the Zero load (-) reading.
 - g.) Press the red down arrow key followed by the red Enter button to select FullScale (-) and proceed to the input screen.
 - The direction must be set to Bi-Directional for a – input in CALIBRATION.
 - h.) With the full load on the sensor, which results in the full negative output, press the red Enter button to capture the FullScale (-) reading.
- 18.) Using the red down arrow key followed by the red Enter button select PULSE / ROTATE.
- a) The PULSE / ROTATE menu is selectable only for profiles that specify PULSE as the sensor type.
 - b) Typical FUTEK settings are 360 and 60.
- 19.) Using the red left and red right arrow keys select the digit to be changed. Using the red up and red down arrow keys set the value for the selected digit that corresponds to the encoder Pulse counts. Use the red ENTER button to save the value.
- a) The default value is set to 360.
 - b) See section 6.1.3.8 of the IHH500 manual for more information on PULSE / ROTATE.
- 20.) Using the red down arrow key followed by the red Enter button select SERIAL NUMBER.
- 21.) Using the red left and red right arrow keys select the digit to be changed. Using the red up and red down arrow keys set the value for the selected digit that corresponds to the sensor's serial number. Use the red ENTER button to save the value.
- 22.) Press the red Back button to exit the NEW CHANNEL setup and return to the SENSOR PROFILE menu.
- 23.) Using the red down arrow key followed by the red ENTER button select SAVE CHANGES to save and create current sensor profile.
- 24.) Press the red Back button to exit the SENSOR PROFILE menu and return to the IHH500 main menu.
- 25.) Press the red Back button to exit the IHH500 menu and return to the normal operation screen.
- 26.) The normal operating screen will now be displayed with the current peak reading, sensor output, valley reading, selected channel, gross or tare mode, and samples per second (sps).
- a) Press the Display button to display additional information from encoder when available.

Release Information

IHH500 Output Guide – Initial Release November 2011

Copyright

Copyright © FUTEK Advanced Sensor Technology, Inc. 2011.

Disclaimer

Neither the whole nor any part of the information contained in, or the product described in this manual, may be adapted or reproduced in any material or electronic form without the prior written consent of the copyright holder.

This product and its documentation are supplied on an as-is basis and no warranty as to their suitability for any particular purpose is either made or implied.

This document provides preliminary information that may be subject to change without notice.

Contact Information

FUTEK Advanced Sensor Technology, Inc.

10 Thomas, Irvine, CA 92618, USA

Toll Free: (800) 23-FUTEK

Telephone: (949) 465-0900

Fax: (949) 465-0905

Email (All Inquires): futek@futek.com

Website URL: www.futek.com

User's Guide

www.futek.com
Email:futek@futek.com



IHH500
Intelligent Digital Handheld Display

TABLE OF CONTENTS

1	RECEIVING & UNPACKING	5
1.1	Unpacking	5
1.2	Storage	5
1.3	Accessories Supplied	5
1.4	Optional Accessories.....	5
2	SAFETY CONSIDERATIONS & CARE FOR YOUR DEVICE	6
3	IMPORTANT INFORMATION FOR IHH500	7
3.1	Performance.....	7
3.2	Product Introduction.....	7
4	CONNECTOR & WIRING DIAGRAM	9
5	FEATURES	10
5.1	IHH500 Overview	10
5.2	IHH500 Structure	14
5.3	Main Display.....	15
6	MAIN MENU OVERVIEW	21
6.1	Sensor Profile	24
6.1.1	Existing Channels.....	25
6.1.2	View Channel.....	26
6.1.3	New Channel.....	27
6.1.3.1	Sensor Configuration.....	29
6.1.3.2	Direction.....	30
6.1.3.3	Unit selection	31
6.1.3.3.1	Force (MASS)	32
6.1.3.3.2	Torque.....	33
6.1.3.3.3	Pressure.....	34
6.1.3.3.4	Displacement	35
6.1.3.3.5	mV/V.....	36
6.1.3.4	Sensor Capacity	37
6.1.3.5	Sensitivity (+).....	38
6.1.3.6	Sensitivity (-).....	39
6.1.3.7	Calibration.....	40
6.1.3.7.1	Zero Load (+)	40
6.1.3.7.2	Full Scale (+).....	41
6.1.3.7.3	Zero Load (-)	41
6.1.3.7.4	Full Scale (-).....	41

Front Panel Button	Function of Button in Menu Mode	Function of Button in Normal Mode
	Enter key	Displays battery life time
	▲ arrow button	Allows the user to toggle between displaying the gross or tare values. This can be useful in many applications when it is necessary to display the change in values from a certain point of measurement range.
	Back Button (to go back one step in the menus)	You can switch between peak, tracking and valley in large font This key selects one of the four different states in normal mode and one of the five different states when a rotary sensor with encoder is being monitored. In this case rpm, torque, angle and power will be displayed.
	◀ arrow button	To reset peak/ valley or angle (in rotary sensors with encoder)
	Navigation Start Key	_____
	▶ arrow button	You can toggle between four groups of engineering units (Force, Torque, Pressure, and Displacement) and standard mV/V Each unit can be converted to another unit in its category: See Note below*
	Exit button	Shunt values can be displayed at any point of time. The device shunts a resistor across the negative excitation and negative power connections. See Note below*
	▼ arrow button	Hold button allows you to hold/freeze the current display value. An HD sign will be displayed on the LCD showing it has been held. When the button or any other key is pressed, the hold display command will be cancelled. See Note below*
		To switch the IHH500 power ON or OFF

6.1.3.8	Pulse per rotation	42
6.1.3.9	Serial number	43
6.1.3.10	Limit & THD	44
6.1.3.10.1	First Peak THD.....	45
6.1.3.10.2	First Valley THD	46
6.1.3.10.3	MIN/MAX Differentiation.....	48
6.1.3.10.4	Alarm Limit High	50
6.1.3.10.5	Alarm Limit Low.....	51
6.1.3.10.6	Auto Reset Timer	53
6.1.4	Edit Channel.....	54
6.1.4.1	Sensor Configuration.....	56
6.1.4.2	Direction.....	56
6.1.4.3	Unit selection	56
6.1.4.3.1	Force (MASS)	56
6.1.4.3.2	Torque.....	56
6.1.4.3.3	Pressure.....	56
6.1.4.3.4	Displacement	56
6.1.4.3.5	mV/V.....	56
6.1.4.4	Sensor Capacity	56
6.1.4.5	Sensitivity (+).....	56
6.1.4.6	Sensitivity (-).....	56
6.1.4.7	Calibration.....	56
6.1.4.7.1	Zero Load (+)	56
6.1.4.7.2	Full Scale (+)	56
6.1.4.7.3	Zero Load (-).....	56
6.1.4.7.4	Full Scale (-).....	56
6.1.4.8	Pulse per rotation	57
6.1.4.9	Serial number	57
6.1.4.10	Limit & THD	57
6.1.4.10.1	First Peak (THD)	57
6.1.4.10.2	First Valley (THD).....	57
6.1.4.10.3	MIN/MAX Differentiation.....	57
6.1.4.10.4	Alarm Limit High	57
6.1.4.10.5	Alarm Limit Low.....	57
6.1.4.10.6	Auto Reset Timer	57
6.1.5	Save Changes.....	58
6.1.6	Delete Channel.....	60
6.2	System Setting.....	63
6.2.1	Digit Select	64
6.2.2	Channel Select	65
6.2.3	Moving Average	66
6.2.4	Sampling Rate.....	68
6.2.5	Peak/ Valley	69
6.2.6	Auto Reset.....	70
6.2.7	Alarm Configuration	71
6.2.8	Alarm Activity.....	72
6.3	Data Logging.....	73
6.3.1	Logging Rate.....	74
6.3.2	Duration (SEC).....	75
6.3.3	Action	76
6.4	Output Configuration	78
6.4.1	Digital ASCII	79

6.4.2	Alarm Relay 1	80
6.4.3	Alarm Relay 2	81
6.4.4	Voltage Configuration	82
6.4.5	Current Value	83
6.4.6	Current Configuration	84
6.5	Interfaces	85
6.5.1	USB Output	87
6.5.2	ASCII output	88
6.5.3	Relay 1 Output	89
6.5.4	Relay 2 Output	90
6.5.5	Voltage Output	91
6.5.6	Current Output	92
6.5.7	Power Output	93
6.5.8	Bridge Input	94
6.5.9	Voltage Input	95
6.5.10	Current Input	96
6.5.11	Pulse Input	97
6.6	LCD Setting	98
6.6.1	Contrast	99
6.6.2	Brightness	100
6.6.3	Auto LCD off	101
6.7	Lock Settings	102
6.7.1	Lockout Profile	103
6.7.2	Unlock profile	104
6.7.3	Change Password	105
6.8	TEDS Data	107
6.8.1	TEDS Device	108
6.8.2	TEDS Page	109
6.8.3	Load Data	110
6.8.4	Auto Detection	111
6.9	Diagnostic	112
6.9.1	Internal or External	113
7	APPENDIX A (LIST OF PROBABLE ERRORS)	114
8	APPENDIX B (LIST OF MESSAGES)	115
9	APPENDIX C (DEVICE SPECIFICATIONS)	117
10	APPENDIX D TEDS IEEE 1451.4 INTRODUCTION	119
10.1	What is TEDS?	119
10.2	Basic Concept	119
10.3	How it works	119
	APPENDIX E (SYSTEM PERFORMANCE)	120

1 Receiving & Unpacking

1.1 Unpacking

Check all parts to ensure no damage was done in transit.

If you suspect that your product is damaged, contact FUTEK at futek@futek.com for immediate support.

1.2 Storage

If the device is to be stored for a prolonged period, take the following safety precautions:

- The storage temperature should be between 0°C and +70°C (32°F to 158°F).
- Cover all connectors with dust protection caps.
- Store in a dry environment.
- If possible, store the instrument in its original packaging when not in use.

1.3 Accessories Supplied

- Battery charger with US plugs (2 pin connector).
- Dust protection caps

1.4 Optional Accessories

- USB Cable (4 pin connector).
- Output Cable (8 pin connector).
- Sensor Cable (12 pin connector).

Caution

FUTEK is not responsible for any damage or injury caused by misuse, misunderstanding, or abuse of this product.

2 Safety Considerations & Care for Your Device

- Do not disassemble for modifications or repair.
- Be sure to disconnect the power cable and turn the device off, when connecting or disconnecting any of the connectors.
- Do not operate the device in the following environments:
 - Direct sunlight.
 - Where the product will be splashed with water, oil and chemicals
- Do not throw, drop, or scratch with any sharp objects.
- In order to extend the built-in lithium battery life. the intelligent battery charger circuit has different curves:
 - **Fast charge:** after 2 hours the battery will be charged around 60%
 - **Normal charge:** It takes about 6-7 hours to charge the battery around 90%
 - **Slow charge:** it takes about 10 hours for fully charging the battery.

Note: It is recommended to use the **Slow charge** at least once a week

Note: Always use the FUTEK supplied charger to charge the battery.

- Use the dust protection caps to cover the connectors when you are not using the device.

3 Important Information for IHH500

3.1 Performance

The IHH500 is a microcontroller based digital handheld instrument that monitors the activity of a vast range of sensors. This includes Wheatstone bridge strain gauge and amplified output Torque/ Force/ Pressure/ Displacement sensors. All of the measurements are based on a high accuracy, low noise, 24 bit resolution Analog to Digital Converter with a non-linearity of 0.001% and a temperature coefficient factor of less than 5 PPM (zero and span drift). All analog components not only those ones that provide the requirements for ADC such as reference voltage but also the ones which are employed for analog output, excitation voltage and input/output buffers are low noise, low distortion, low temperature coefficient, and high precision/accuracy parts. The combination of these components, along with a high speed microcontroller integrated with a precision DAC controller has provided a high accuracy instrument, which is able to measure the activity of a 2 mV/V sensor with up to a 500,000 count (total) noise free base! The high precision DAC controller has been exploited to provide a ± 5 V voltage output with 100 μ V resolution and/or (0-25mA) current output with a 0.5 μ A resolution. A wide range of bridge resistances and input/output impedances of external instruments can be applied to this device without any lack of performance.

The IHH500 accepts amplified Voltage input (± 12 VDC), Current input (up to 30mA), Bridge input (up to 500 mV/V), and Pulse/ TTL input (up to 650,000 pulses per second) and has the capability to provide power to FUTEK rotary torque sensors (24 VDC/ 1 W and 5 VDC/ 0.05 W).

3.2 Product Introduction

- TEDS IEEE 1451.4 compliant with template 30 for High level voltage output sensors and template 33 for bridge sensors.
- Ability to interact with TEDS data by using the SensIT software interface.
- Selectable calibration method including live calibration by applying the actual load or manipulating method by entering the sensitivity.
- Ability to measure bridge resistance.
- Automated sensitivity calculation based on calibration value.
- Dual scaling calculation for bi-directional sensors.
- Selectable units of measure for Force, Torque or Pressure and Displacement with automatic conversion of units between readings.
- Selectable sampling rate from 5 samples per second to ultra-fast signal sampling rate of 4800 samples per second in 16 different speeds.
- Selectable moving average method for software filtering.
- Peak/ Valley and First Peak/ First Valley functions.
- Manual and auto peak/valley reset functions.
- Tare/ Gross functions with indicator.
- Tracking/Hold functions with indicator.
- Built-in shunt calibration features with indicator.
- Lockout feature to prevent inadvertent changes.
- Data logging with up to 21'000 points.
- Supports USB link port.
- Built-in load cell excitation voltage.
- Powered by a rechargeable 3000 mAh lithium-polymer battery for up to 24 hours of operation.

- Battery/ life indicator with bar graph and text indicators.
- Selectable automatic display shutoff for period of inactivity (up to 15 minutes).
- Selectable latched or non-latched alarm configuration.
- ASCII Stream Output.
- Two independently isolated solid state alarm relays, each able to be disabled or enabled individually, with normally open or closed operations and protected at 110mA/110V.
- Selectable voltage output as bipolar (± 5 V) or uni-polar (0-5V) with 2.5V offset.
- Selectable current output as bidirectional and unidirectional.
- Selectable 0-20mA, 0-25mA, 4-20mA, 5-25mA current output.
- Selectable alarm configuration (Latched or non-Latched)
- Supports Speed (RPM), Angle (Degrees), and Power (W/kW/MW/HP) measurements for rotary torque sensors with encodes.
- Provides a +5.000 V (± 1 mV) excitation voltage to bridge resistances as low as 30 Ohms and as high as 30 Kilo Ohms.
- Default channel calibrated to 0-4 mV/V using precision BLH.
- Back lit 4x16 character LCD with selectable brightness, contrast, and auto shut off.
- Selectable digit height size (4.7 mm and 12.7mm).
- Selectable number of digits to be displayed, excluding the decimal point (3, 4, 5, or 6).
- Equipped with the diagnostic mode to measure bridge resistance, sensitivity, internal voltage (Analog and digital), battery and temperature.
- User friendly navigation menu directs users to enable/disable or select/unselect various features with easy to follow instructions.
- Ability to store 14+1 sensor profiles including calibration values such as Offset, Full scale, Loading point(s) , Engineering unit , Serial number, Sensor type (Bridge, Voltage , Current, Pulse) , Sensitivity, Alarm limits (High and Low) and all Peak/ Valley (First, Hold, Auto reset) Threshold values.
- Active channel number indicator.
- IP66 housing and connectors.
- Aluminum enclosure
- Lead free/ RoHS compliant parts.
- ESD, EMI, EFT and short circuit protected Input and output which covers the CE approval.

Note: IHH500 is available in two versions: Elite and Pro.

4 Connector & Wiring Diagram



Connectors	Description	Diagram (Female Insert)
Sensor connections	Pin A: +E +Excitation Pin B: +S +Signal Pin C: -E -Excitation, TEDS return Pin D: -S -Signal Pin E: TEDS_IO TEDS Data Pin F: 24_OUT 24V output Pin G: GND_OUT Ground Pin H: 5_OUT 5V Output Pin J: -V -V from sensor Pin K: +V +V from sensor Pin L: Leading Pulse From sensor Pin M: Lagging Pulse From sensor	
Output connections	Pin 1: IDAC analog current output signal Pin 2: REFERENCE analog voltage output return Pin 3: +R1 solid state relay1 (positive) Pin 4: VDAC analog voltage output signal Pin 5: +R2 solid state relay2 (positive) Pin 6: GND analog current output return Pin 7: -R1 solid state relay1 (negative) Pin 8: -R2 solid state relay2 (negative)	
USB port connections	Pin 1: VBUS Pin 2: -D Pin 3: +D Pin 4: GND	
Power Connections	Pin 1: 12V Pin 2: Ground (Note: These pins are not polarity sensitive)	

5 Features

5.1 IHH500 Overview





In the welcome message of the Pro version "PRO" will be displayed.
Above it is shown that the IHH500 is submersible

6.1.3.3 Unit selection

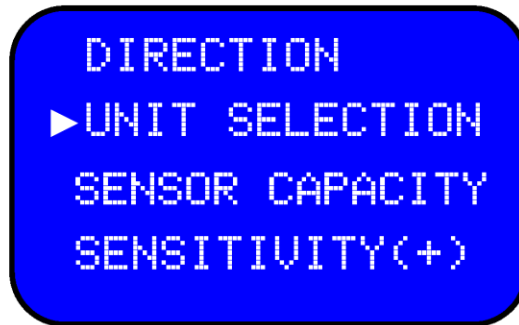

Scroll to "UNIT SELECTION" from "NEW CHANNEL" using the ▲▼ keys and press ENTER. It can also be selected from "EDIT CHANNEL" to make modifications on the existing channel except channel one. Using the ▲▼ keys select one of the following four groups of Engineering Units: FORCE, TORQUE, PRESSURE, and DISPLACEMENT and standard mV/V for the new channel.

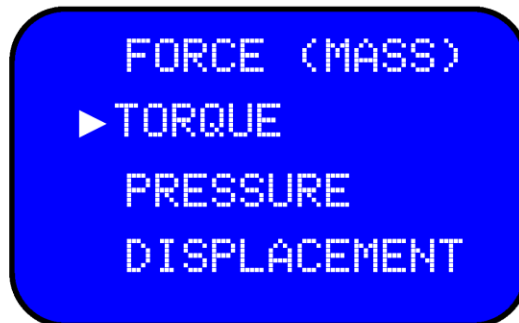

* Note:

Force (Mass) units: μg , mg, g, kg, M- tone, dyn, kdyn, Mdyn, N, kN, oz, lbs, klb, ton (US) and ton (UK).

Torque units: g-mm, g-cm, kg-cm, kg-m, N-mm, N-cm, N-m, KN-m, in-oz, in-lb, and ft-lb.

Pressure units: Pa, kPa, mbar, bar, MPa, kg/cm^2 , atm (standard atmosphere), mm-HG, in-H₂O, ft-H₂O, psi, and kpsi.

Displacement units: mm, cm, dm, m, km, in, ft, yds, and mile.

When a torque sensor configured, on the main page showing the speed, angle and torque, the HOLD and SHUNT keys are not accessible. Using the HOLD and SHUNT keys will prompt the warning message.

Pressing the SHUNT will unfreeze the display from HOLD function.

Pressing the HOLD button will not exit the device from the SHUNT mode.

The HOLD and SHUNT keys are disabled on the main page showing the speed, angle and torque. Using the HOLD and SHUNT keys will prompt a warning message.

5.2 IHH500 Structure

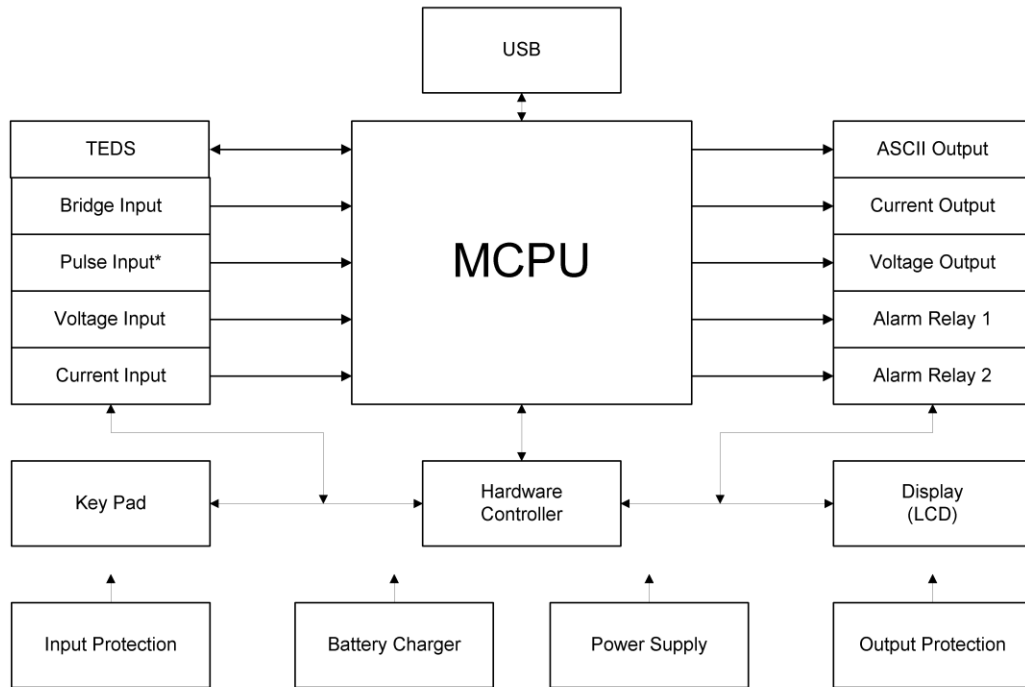

* Available only in Elite Version.

5.3 Main Display

```
FUTEK ADVANCED  
SENSOR TECH INC.  
IHH500 - ELITE  
MADE IN USA
```

**Welcome message will
be displayed at power on**

```
AUTO CALIBRATION  
IN PROGRESS  
PLEASE WAIT 11  
....
```

Auto calibration will be applied when device is turned on. The calibration will minimize any effects of the temperature drift for either zero (offset) or span. During the auto calibration process the key pad is locked out and inaccessible. Brief information about the active channel will be displayed when calibration is complete.

Depending on whether TEDS detect is enabled or not (see section 6.8.4), the following Sensor Profile will be displayed for 10 seconds: TEDS enabled (left), TEDS disabled (right).

```
TEMPLATE      33  
SERIAL        123456  
20.0000      LBS  
1.98765      mU/U
```

```
CHANNEL       01  
SERIAL        1  
SENSOR        BRIDGE  
+2.00000     mU/U
```

After 10 seconds the following message will be displayed.

```
+2.00001     Peak  
+2.00000     mU/U  
+1.99999     Valley  
01 Gross     5 SPS
```

Pressing the display key will change the reading to a larger font. Pressing it again will switch between modes while still in the large font. The tare and gross modes can also be used while in the larger font mode.

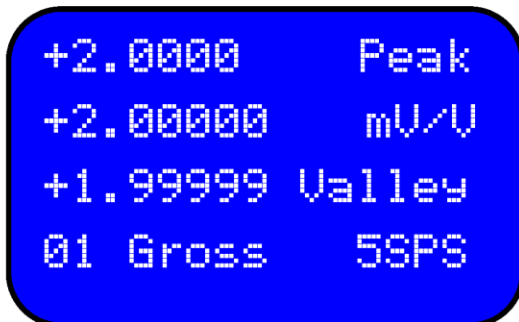

After displaying the Valley, the next change will direct you to the main page again.

For rotary torque sensors, the following screen will be displayed before returning to the main screen.

NOTE: To display the encoder information in IHH500 SenselT software during the live graphing to monitor Torque, Speed, Angle and power, the screen of IHH500 shall be changed by pressing the "DISPLAY KEY". The following screen will be displayed:

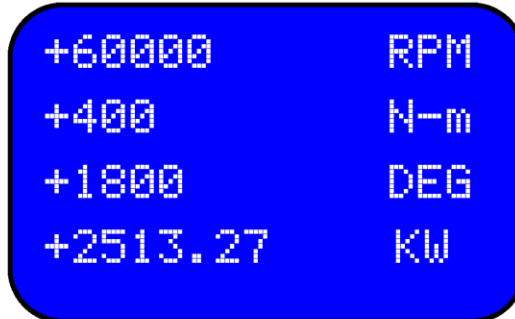

If an incorrect unit (other than torque units) has been selected for a rotary torque sensor, an error message will be displayed on the last row.

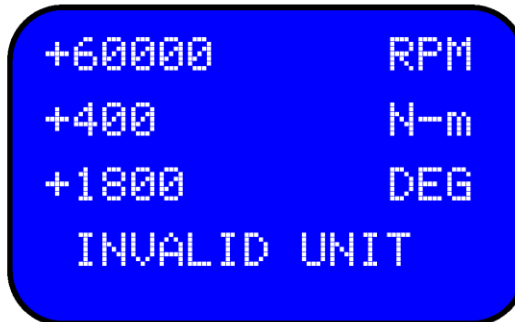

Note: when a torque or rotary sensors are selected, on the main page showing the speed, angle and torque, the HOLD and SHUNT keys are not accessible. Using the HOLD and SHUNT keys will prompt a warning message.

The shunt key can be pressed any time after the device has been calibrated and a new sensor profile has been loaded. The simulated value is to be used as a calibration reference. SHUNT will blink on the display.

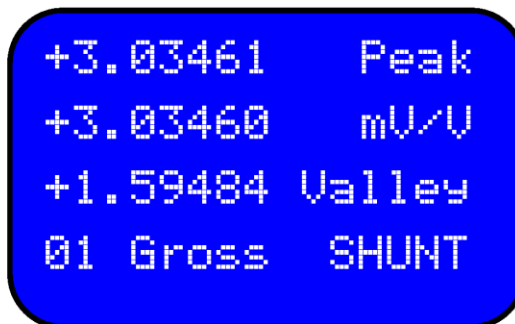

When both SHUNT and HOLD are active on the last row, the display will switch between blinking SHUNT and blinking HOLD.

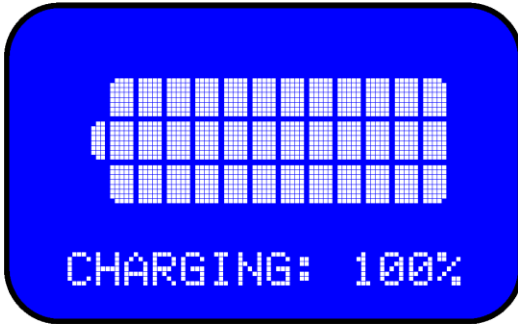

The Battery Key will allow you to view the battery life time.

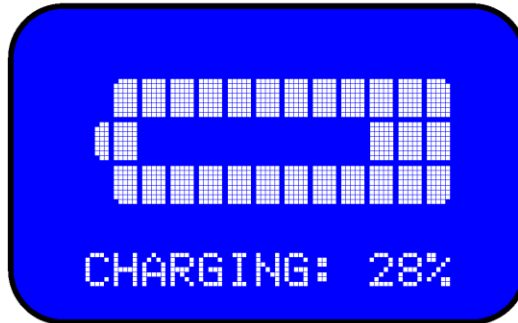

Pressing the battery button while the charger is plugged in, will display a battery charging screen.

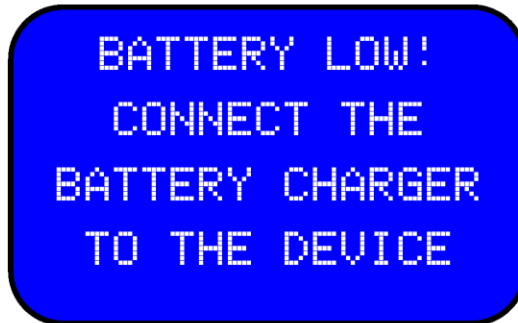

Whenever the battery level drops below 6.5V, a warning message will be displayed.

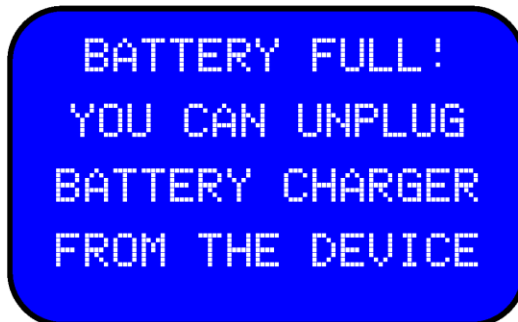

Whenever the battery level exceeds 8V and the charger is connected, a warning message will be displayed.

There are two pulse signals, P1 and P2 that are used to indicate speed, angle, power, and direction of rotation. These pulses are 90 degrees out of phase, and depending on which pulse is leading or lagging or how many pulses are present in a certain time frame, the IHH500 can calculate these values.

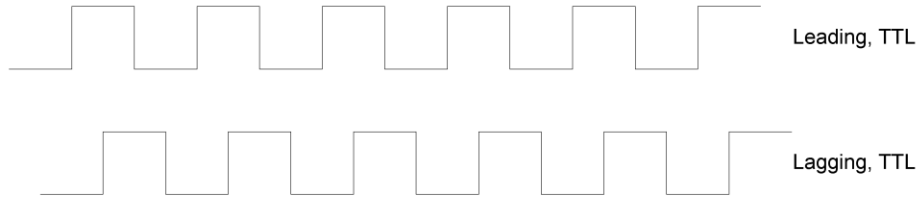

Calculation of Power

Power is calculated by using the following formula:

$$P = T \times N = \frac{T \times 2\pi \times RPM}{60000}$$

Where:

P: mechanical power in kW
T: torque in N-m
RPM: speed in rev / min

Calculating the Power Units:

- If the **g-mm, g-cm, g-m** or **N-mm** units have been defined, the mechanical power is automatically calculated in **WATT**.
- If the **kg-cm, kg-m**, or **N-m** units have been defined, the mechanical power is automatically calculated in **kW**.
- If the **kN-m** unit has been defined, the mechanical power is automatically calculated in **MW**.
- If the **ln-lb, oz-in** or **ft-lb** units have been defined, the mechanical power is automatically calculated in **HP**.

Direction of Rotation:

Since there are two pulses, a direction of rotation (CW or CCW) can be defined depending on which pulse is leading.

Calculation of Speed:

The input frequency that can be evaluated for recording the speed is used in defining the speed. The input speed based on the pulses per rotation can be calculated as follows:

$$N = \frac{f \times 60}{PPR}$$

Where:

N: Speed (RPM)

f: Frequency

PPR: User-defined pulses per rotation (selectable up to 9999)

Angle calculation:

After calculating the Angle will be computed based on pulse per rotation.

$$\alpha = \frac{RPM}{60} \times PPR$$

Where:

RPM: Revolution per Minute

PPR: Pulse per Rotation

α: Angle

Note: the resolution of Angle calculation is 1 degree.

6 Main Menu overview

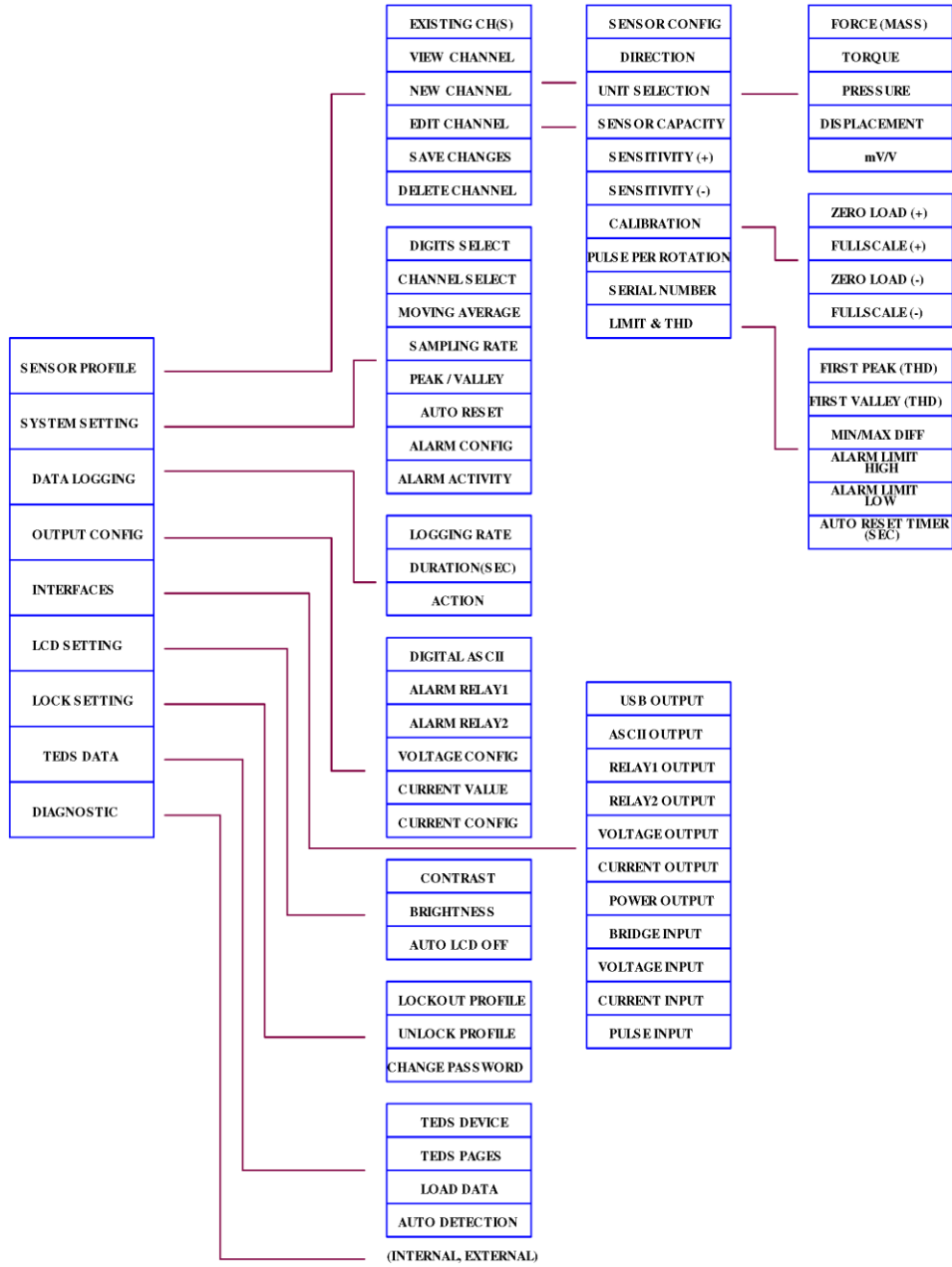

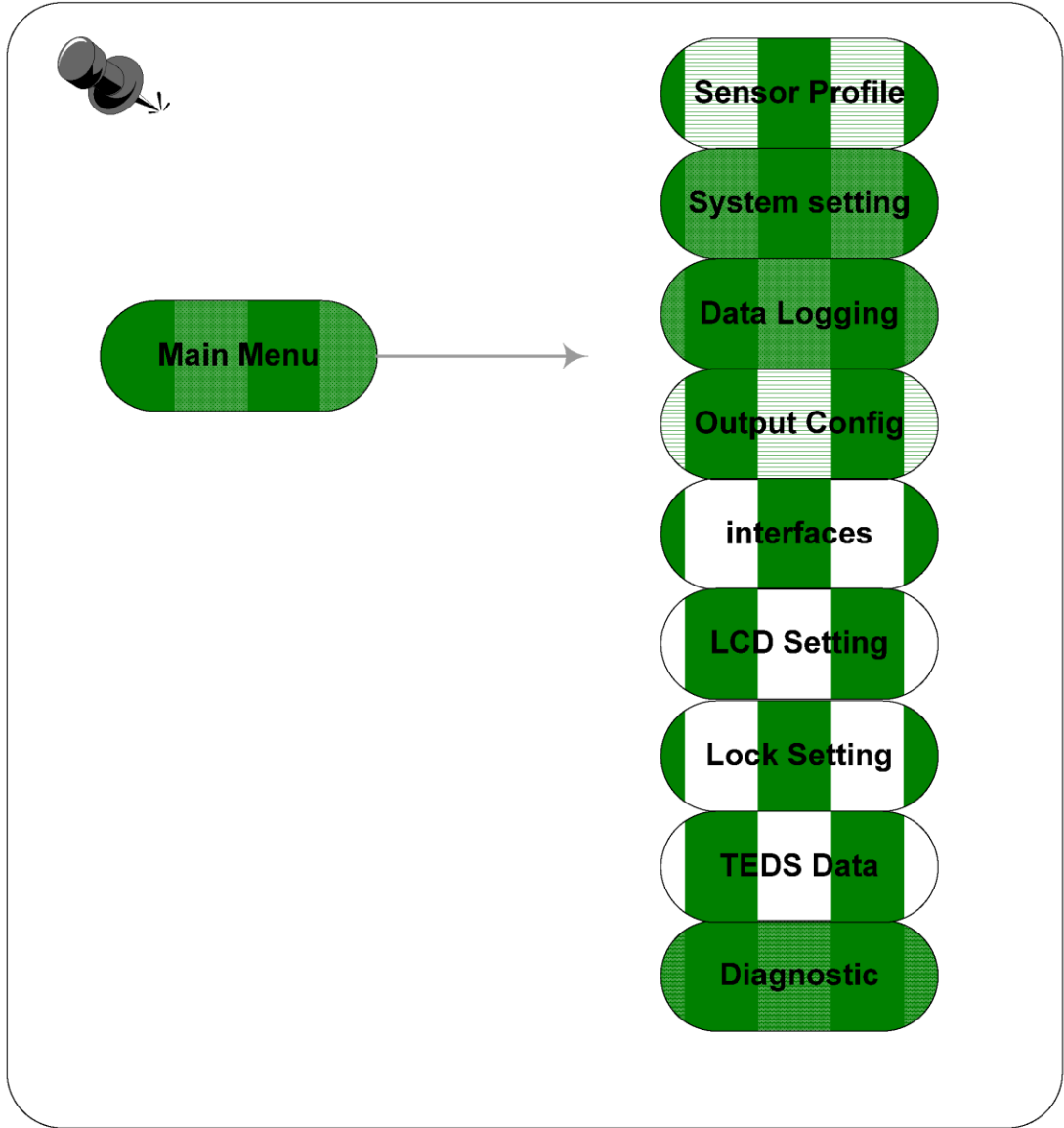

```
SENSOR PROFILE
SYSTEM SETTING
▶ DATA LOGGING
OUTPUT CONFIG
```

```
INTERFACES
LCD SETTING
▶ LOCK SETTING
TEDS DATA
```

```
LOCK SETTINGS
TEDS DATA
▶ DIAGNOSTIC
-----
```

Press the MENU key to enter the main menu.

Use ▲▼ keys to select the desired menu option.

Press ENTER to navigate to the submenu.

The EXIT button can be used at any time to exit any menu or sub menu and return to the display page.

The BACK button can be used at any time to step back from any sub menu.

6.1 Sensor Profile

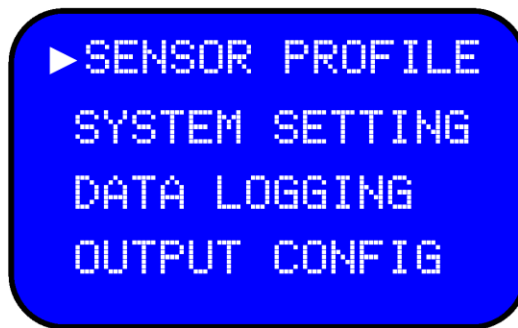
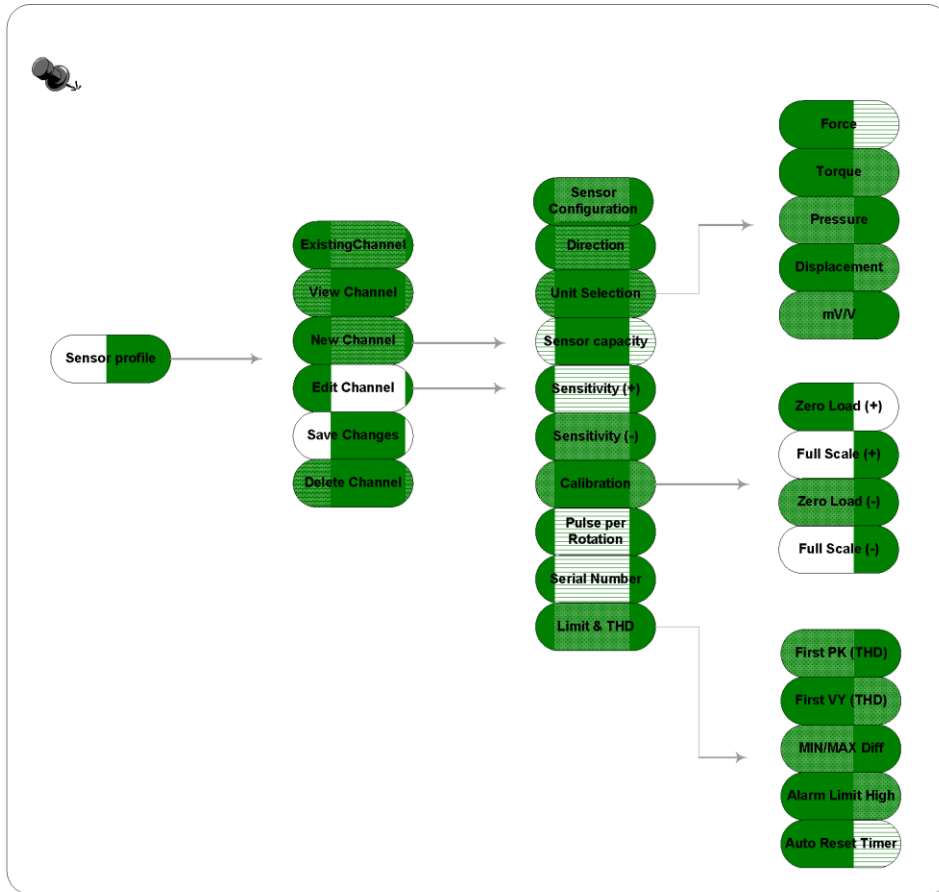

Select “**SENSOR PROFILE**” from the main menu options and press **ENTER**. The following options are available: **EXISTING CH(S)**, **VIEW CHANNEL**, **NEW CHANNEL**, **EDIT CHANNEL**, **SAVE CHANGES** and **DELETE CHANNEL**.

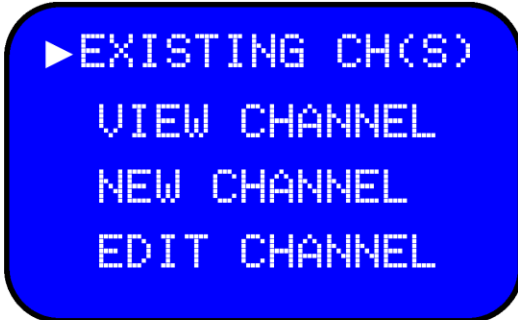

6.1.1 Existing Channels

Scroll to “**EXISTING CH(S)**” using the ▲ ▼ keys and press **ENTER** to view the different sensor profiles. The IHH500 is able to store up to 15 different sensor profiles.

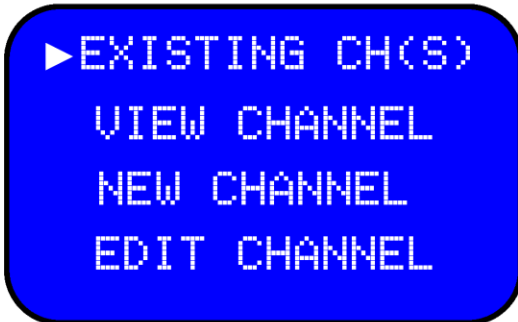

The active channel number will be shown with a check mark row on right.

This function is useful to have a quick view of the number of channels (sensor profile) that have been stored in the internal memory and whether they are active or not. The active channel has a check mark.

For example in this specific figure only channel 01 exists and is active.

TEDS activity is shown separately. If TEDS is present it will be shown in the blank area.

BACK can be pressed at any time to return to other sensor profile options.

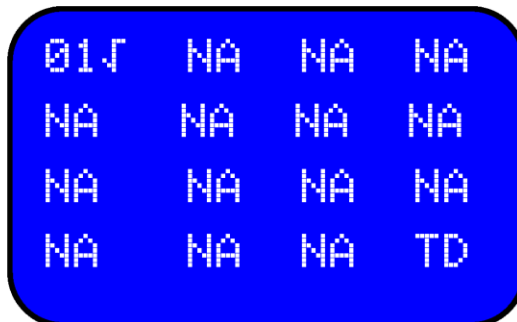

6.1.2 View Channel

Scroll to select "VIEW CHANNEL" from the "SENSOR PROFILE" using the ▲▼ keys and press **ENTER** to view: channel number, sensor type, serial number, capacity and engineering unit. If currently more than one channel exist, pressing the arrow ◀▶ keys on the keypad will cycle through the existing channels.

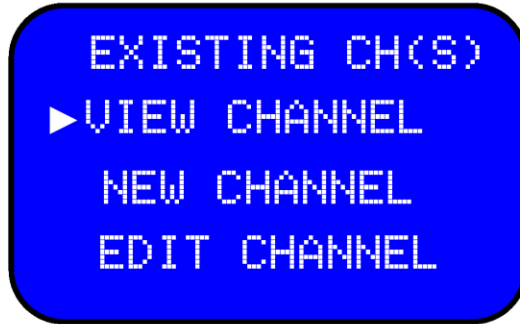

6.1.3 New Channel

Scroll to “NEW CHANNEL” from the “SENSOR PROFILE” using the ▲▼ keys and press ENTER. Use the ◀▶ to select the remaining 2 to 15 channel. Press ENTER to set the data for desired channel.

Note: The first channel is already set as default and will be displayed on the screen if no other channel has been set.

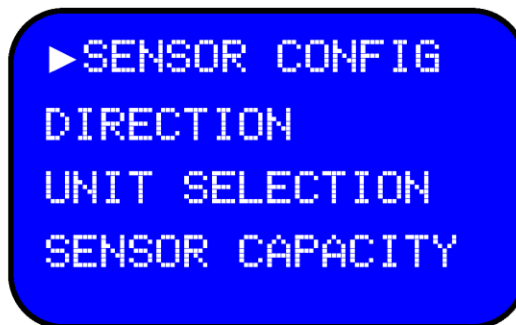
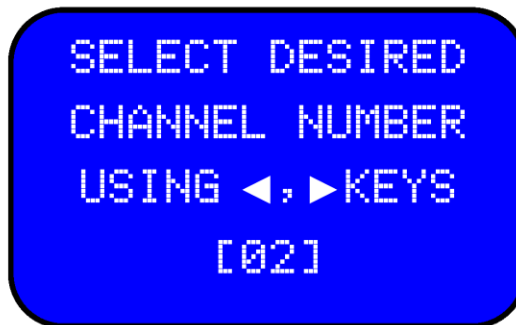
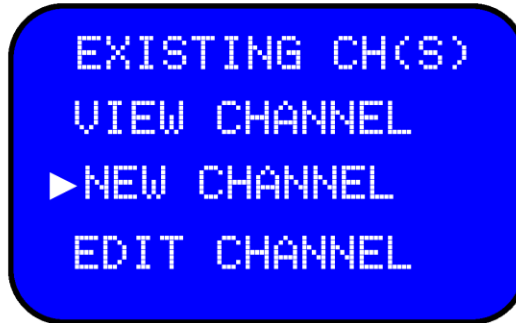

Moreover, the new channel detail can be seen on the existing channel and view channel options. Once decided to go back or exit in the middle of new channel settings, the following message will be shown: “sensor profile is not saved yet”.

In order to set the new channel data the following steps must be taken exactly in the order of which it is shown on the screen, the ▼ key cannot be used to skip the steps. Once **EXIT** is pressed while setting the new channel or editing an existing channel, following warning message will be displayed:

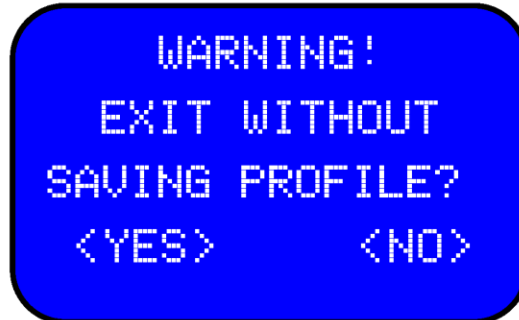

This function is not available if lockout option is enabled. See section 6.7 for lock settings for further information how to enable or disable settings. If this device is being used for the first time, it is not been locked yet.

If this device is already locked following message will appear if "NEW CHANNEL" is selected:



6.1.3.1 Sensor Configuration

Scroll to "SENSOR CONFIG" from "NEW CHANNEL" using ▲▼ keys and press the ENTER to set a new channel. "SENSOR CONFIG" can also be selected from "EDIT CHANNEL" to make modifications on the existing channels except channel 1. Use the ◀▶ keys to select the sensor type as either "FULL BRIDGE", "VOLTAGE OUTPUT", "CURRENT OUTPUT", "BRIDGE & PULSE", "VOLTAGE & PULSE" or "CURRENT & PULSE".

Note: Pulse selection is only available in Elite Version.

Any time a new sensor type is selected, which was not defined before, the device will automatically calibrate itself after it loads the new profile. The following messages will be seen on the screen.

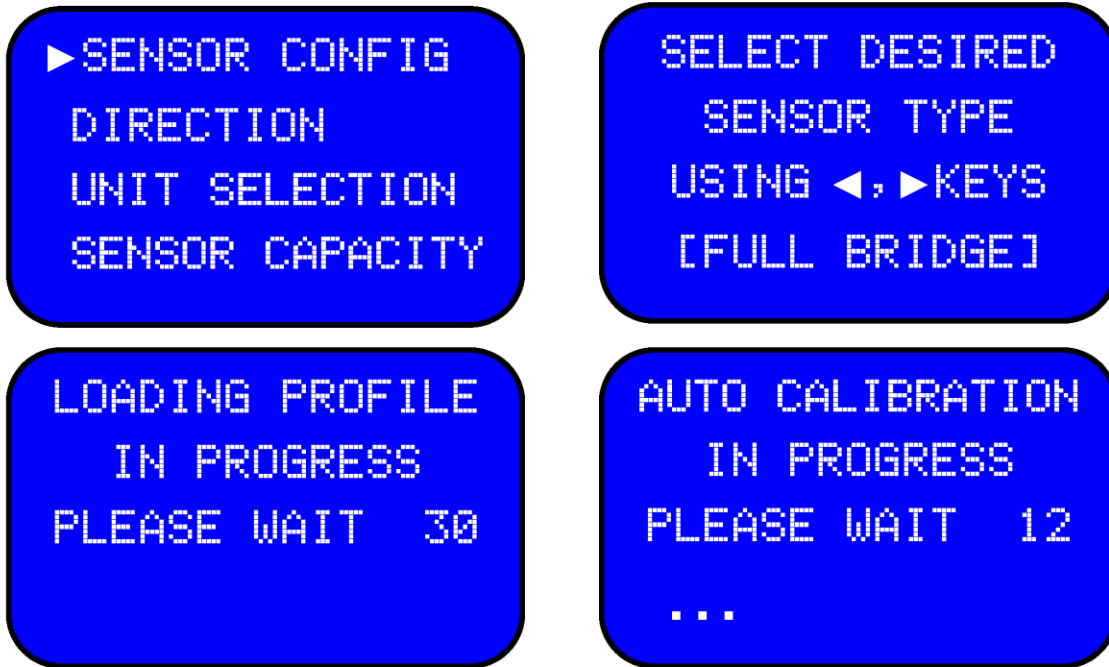

The following message may be seen if the sensor type is the same as current profile.

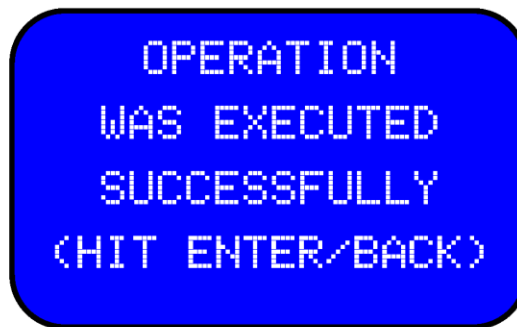

6.1.3.2 Direction

Scroll to "**DIRECTION**" from "**NEW CHANNEL**" using the ▲▼ keys and press **ENTER**.
"**DIRECTION**" can also be selected from "**EDIT CHANNEL**" to make modifications on the existing channels except channel one.

Using the ◀▶ keys on the keypad select either uni-direction or bi-direction.

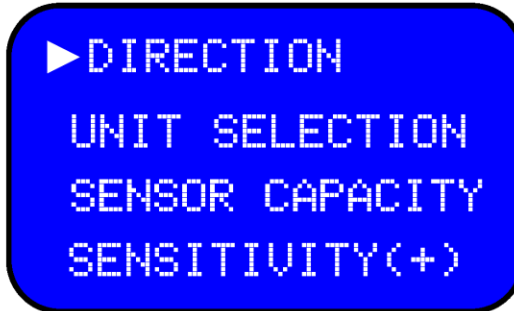

▶ DIRECTION
UNIT SELECTION
SENSOR CAPACITY
SENSITIVITY(+)

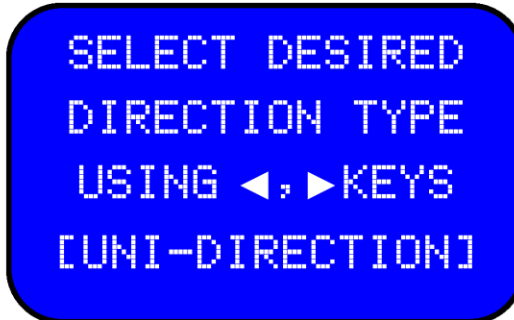

SELECT DESIRED
DIRECTION TYPE
USING ◀, ▶ KEYS
[UNI-DIRECTION]

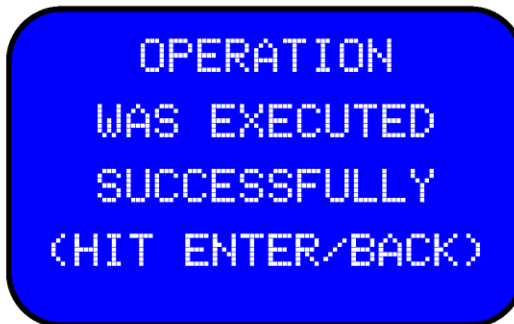

OPERATION
WAS EXECUTED
SUCCESSFULLY
(HIT ENTER/BACK)

6.1.3.10.4 Alarm Limit High

Scroll to "ALARM LIMIT HI" from "LIMIT(S) & THD(S)" using the ▲▼ keys and press ENTER.

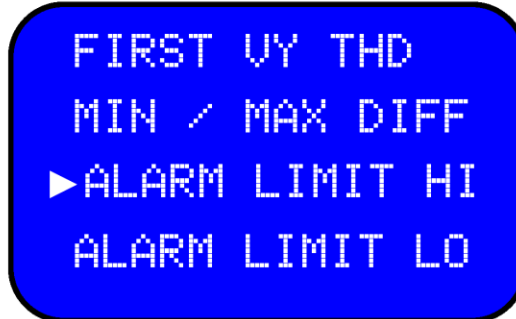

Use the arrow keys to move the cursor among the digits and select the desired number for the Alarm Limit High. The sign value can also be changed from positive to negative in case a bi-directional sensor is configured.



A confirmation message will be displayed confirming operation was successfully executed.

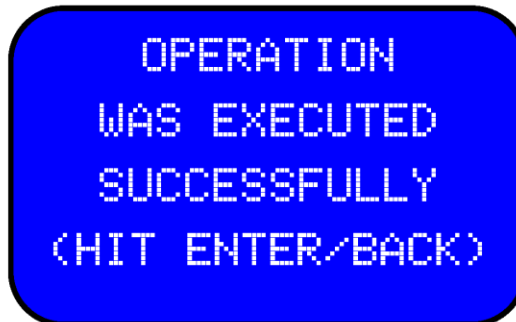

(See Figure no.4 and 5 on page 52 for examples of alarm threshold levels for one directional and two directional sensors).

6.1.3.3.1 Force (MASS)

Scroll to "FORCE (MASS)" from "UNIT SELECTION" using the ▲▼ keys and press ENTER. The following options can be selected for force: μg , mg, g, kg, M- tone, dyn, kdyn, Mdyn, N, kN, oz, lbs, klb, ton (US) and ton (UK). Once the desired force unit is selected, the following message will appear.

```
▶ FORCE (MASS)
TORQUE
PRESSURE
DISPLACEMENT
```

```
SELECT DESIRED
ENGINEERING UNIT
USING ◀, ▶ KEYS
[μg]
```

```
OPERATION
WAS EXECUTED
SUCCESSFULLY
(HIT ENTER/BACK)
```

6.1.3.3.2 Torque

Scroll to "TORQUE" from "UNIT SELECTION" using the ▲▼ keys and press ENTER. The following options for torque can be selected: g-mm, g-cm, g-m, kg-cm, kg-m, N-mm, N-cm, N-m, kN-m, in-oz, in-lb, and ft-lb. Once the desired torque unit is selected, the following message will be shown.

```
FORCE (MASS)
▶ TORQUE
PRESSURE
DISPLACEMENT
```

```
SELECT DESIRED
ENGINEERING UNIT
USING ◀, ▶ KEYS
[g-mm]
```

```
OPERATION
WAS EXECUTED
SUCCESSFULLY
(HIT ENTER/BACK)
```

Note: When a torque or rotary sensor is selected, the HOLD and SHUNT keys are not accessible on the main page showing the speed, angle and torque. Pressing the HOLD and SHUNT keys will prompt a warning message.

6.1.3.3.3 Pressure

Scroll to "PRESSURE" from "UNIT SELECTION" using the ▲▼ keys and press ENTER. The following options can be selected for pressure: Pa, kPa, mbar, bar, MPa, kg/cm², atm (standard atmosphere), mm-HG, in-H2O, ft-H2O, psi, and kpsi.

Once the desired pressure unit is selected, the following message will be shown.

```
FORCE (MASS)
TORQUE
▶ PRESSURE
DISPLACEMENT
```

```
SELECT DESIRED
ENGINEERING UNIT
USING ◀, ▶ KEYS
[Pa]
```

```
OPERATION
WAS EXECUTED
SUCCESSFULLY
(HIT ENTER/BACK)
```

6.1.3.3.4 Displacement

Scroll to "DISPLACEMENT" from "UNIT SELECTION" using the ▲ ▼ keys and press ENTER.
The following units can be selected for displacement: mm, cm, dm, m, km, in, ft, yds, and mile.
Once the desired displacement unit is selected, the following message will be shown.



PRESSURE
▶ DISPLACEMENT
mU/U

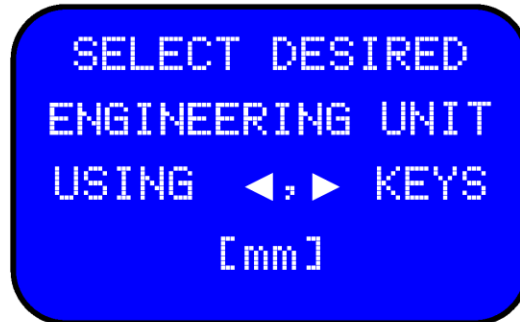

SELECT DESIRED
ENGINEERING UNIT
USING ◀, ▶ KEYS
[mm]

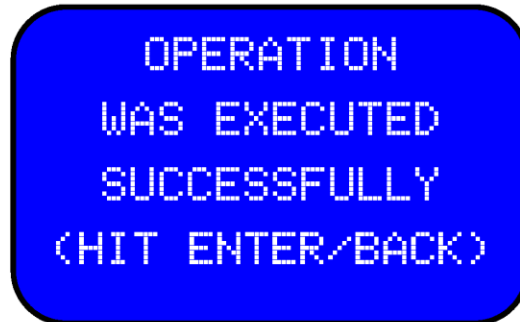

OPERATION
WAS EXECUTED
SUCCESSFULLY
(HIT ENTER/BACK)

6.1.3.3.5 mV/V

Scroll to "mV/V" from "UNIT SELECTION" using the ▲▼ keys and press ENTER .

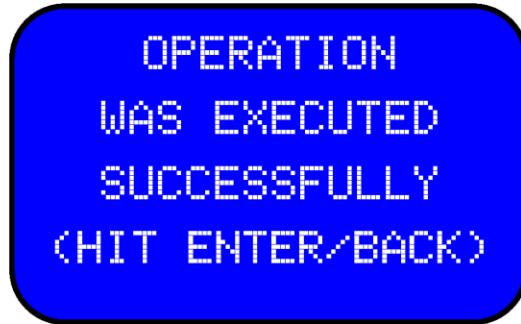

6.1.3.4 Sensor Capacity

Scroll to “**SENSOR CAPACITY**” from “**NEW CHANNEL**” using the ▲▼ keys and press **ENTER**. “**SENSOR CAPACITY**” can also be selected from “**EDIT CHANNEL**” to make modifications on the existing channels except channel one.

Using the ◀▶ keys, move the cursor to the desired placement and use the ▲▼ keys to select the desired number or decimal position. The capacity can be selected from 0.00001 to 9999999.

```
SENSOR CONFIG
DIRECTION
UNIT SELECTION
▶ SENSOR CAPACITY
```

```
SELECT DESIRED
VALUE
USING ARROW KEYS
[2.00000]
```

```
OPERATION
WAS EXECUTED
SUCCESSFULLY
(HIT ENTER/BACK)
```

6.1.3.5 Sensitivity (+)

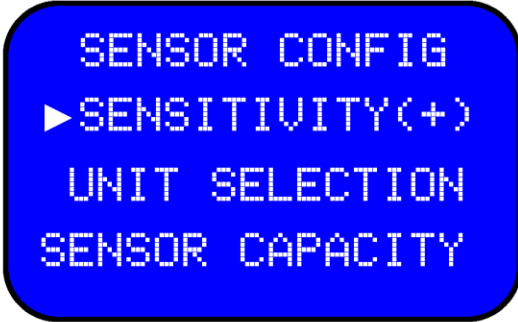

Scroll to “SENSITIVITY (+)” from “NEW CHANNEL” using the ▲ ▼ keys and press ENTER to set the sensitivity for a new channel. “SENSITIVITY” can also be selected from “EDIT CHANNEL” to make modifications on the existing channel except channel one. Sensitivity of the channel can be selected in mV/V using the ◀ ▶ and the ▲ ▼ keys.

If the actual sensitivity is not known, but the specific range is known, use the larger number. For example if the sensitivity of the sensor is between 2 mV/V and 3 mV/V, 3mV/V should be entered. A live calibration would then be needed to find the actual mV/V. Anytime that a new sensor sensitivity is set, the device may do an auto calibration after it loads the new profile.

The following messages will be seen on the screen.

Note: Sensitivity can be defined for bridge sensors and voltage sensors. This option is disabled for current and pulse sensors.

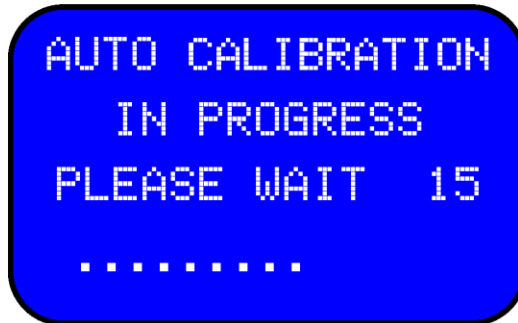
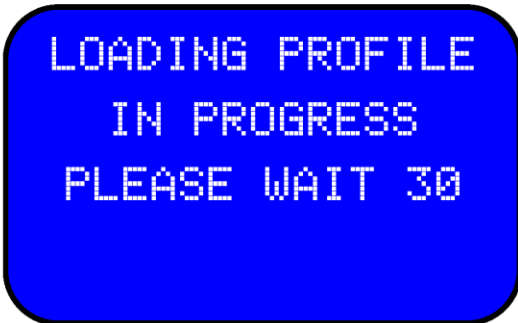

The following message will be seen if the sensor sensitivity is the same as current profile.

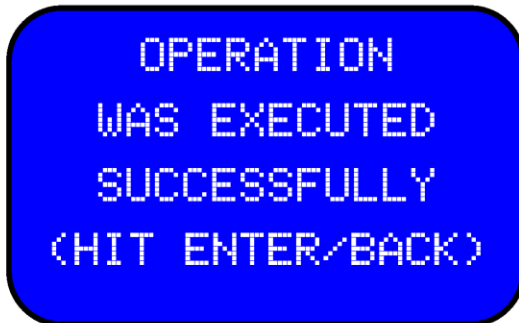

Note: For voltage sensor device asks for voltage output.

6.1.3.6 Sensitivity (-)

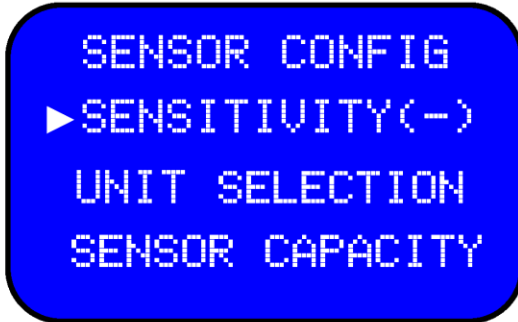

Scroll to “SENSITIVITY (-)” from “NEW CHANNEL” using the ▲▼ keys and press ENTER to set the sensitivity for a new channel. “SENSITIVITY” can also be selected from “EDIT CHANNEL” if to make modifications on the existing channels except channel one. Sensitivity of the channel can be selected in mV/V using the ◀▶ and the ▲▼ keys.

If the actual sensitivity is not known, but the specific range is known, use the larger number. For example if the sensitivity of the sensor is between 2 mV/V and 3 mV/V, 3mV/V should be entered. A live calibration would then be needed to find the actual mV/V. Anytime that a new sensor sensitivity is set, the device may do an auto calibration after it loads the new profile.

Note that sensitivity can be defined for bridge sensors and voltage sensors. This option is disabled for current and pulse sensors.

Note: If a Uni-directional sensor is configured in “DIRECTION” the section is not available, otherwise if the sensor is Bi-directional configured and the following step shall be taken for the negative values:

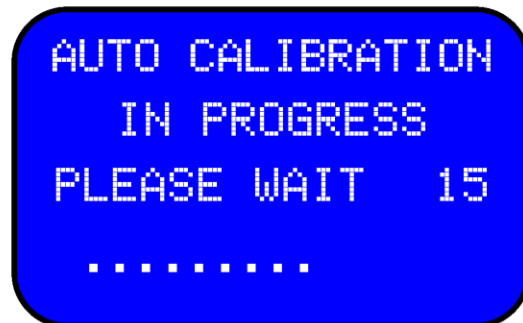
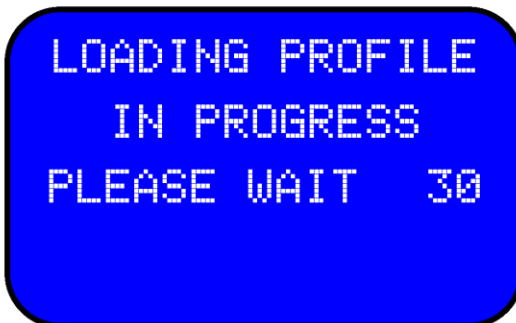

The following message will be seen if the sensor sensitivity is the same as current profile.

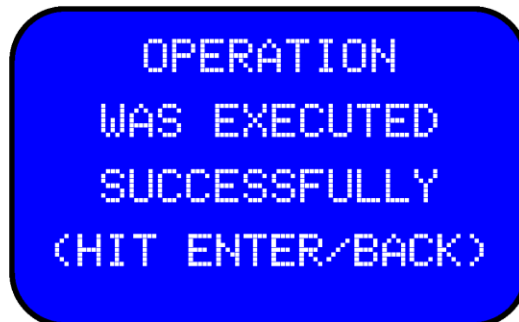

6.1.3.7 Calibration

Scroll to “**CALIBRATION**” from “**NEW CHANNEL**” using ▲▼ keys and press **ENTER** to set it for the new channel. “**CALIBRATION**” can also be selected from “**EDIT CHANNEL**” to make modifications on the existing channels except channel one.

Note: This function is dedicated for precise calibration (live calibration), however if the user would not like to apply the load, in the sensitivity selection (7.1.3.2 & 7.1.3.3) manipulating method **must** be done accurately otherwise the calculation is not correct.

For example: Using a calibration certification with the sensitivity, the number must be entered in the sensitivity selection (7.1.3.2& 7.1.3.3) and this step can be skipped. However it is recommended to use this step and manually live calibrate the sensor.

If user does not have actual sensitivity and has already entered an estimated value in Sensitivity Section (6.1.3.2 & 6.1.3.3) this step must be executed carefully.

After performing all calibration steps and entering zero load and full scale, device is able to calculate the actual SENSITIVITY value and update it. SENSOR CONFIGURATION menu will now contain the actual value.

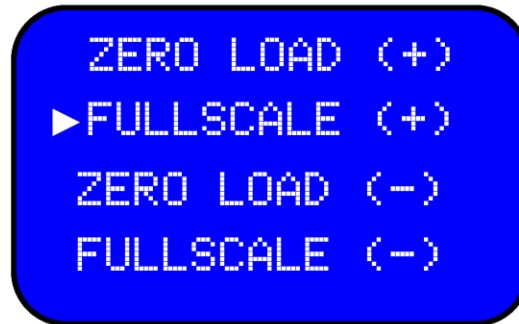
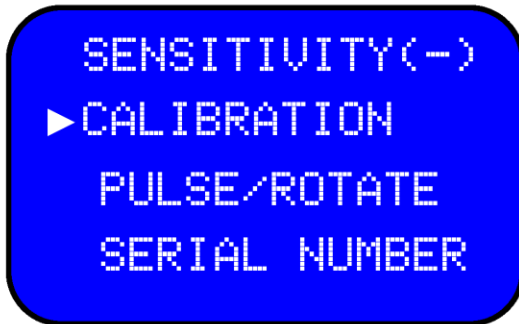

6.1.3.7.1 Zero Load (+)

Scroll to “**ZERO LOAD (+)**” from “**CALIBRATION**” using the ▲▼ keys and press **ENTER**.

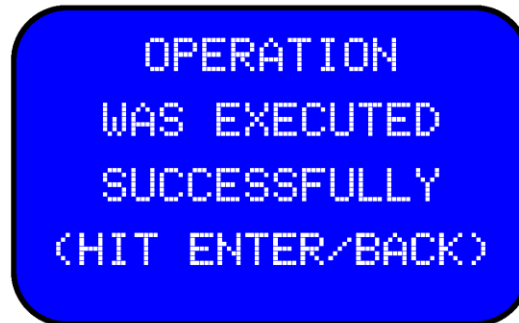

6.1.3.7.2 Full Scale (+)

Scroll to "FULL SCALE (+)" from "CALIBRATION" using the ▲ ▼ keys and press ENTER.

APPLY
FULLSCALE(+)
CALIBRATION
THEN PRESS ENTER

OPERATION
WAS EXECUTED
SUCCESSFULLY
(HIT ENTER/BACK)

If the channel "DIRECTION" is defined as "BI-DIRECTION" it will be prompt to apply the full scale calibration (-) as well as zero load (-) for the reverse direction.

6.1.3.7.3 Zero Load (-)

Scroll to "ZERO LOAD (-)" from "CALIBRATION" using the ▲ ▼ keys and press ENTER.

APPLY
ZERO LOAD(-)
CALIBRATION
THEN PRESS ENTER

OPERATION
WAS EXECUTED
SUCCESSFULLY
(HIT ENTER/BACK)

6.1.3.7.4 Full Scale (-)

Scroll to "FULL SCALE (-)" from "CALIBRATION" using the ▲ ▼ keys and press ENTER.

APPLY
FULLSCALE(-)
CALIBRATION
THEN PRESS ENTER

OPERATION
WAS EXECUTED
SUCCESSFULLY
(HIT ENTER/BACK)

6.1.3.8 Pulse per rotation

Scroll to "PULSE/ROTATE" from "NEW CHANNEL" using the ▲▼ keys and press ENTER. "PULSE/ROTATE" can also be selected from "EDIT CHANNEL" to make modifications on the existing channels except channel one.

Note: This option is only available for rotary sensors with encoders as defined in sensor configuration sub-menu (7.1.3.1).

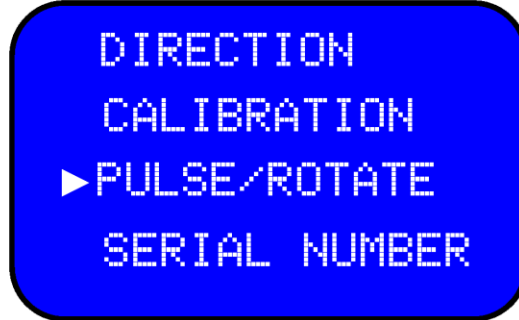

Using the ◀▶ keys, move the cursor to the desired placement, and use the ▲▼ keys the desired number. Number of pulse per rotations (PPR) can be defined for either rotary or speed sensors. Up to 9999 pulse per rotation can be defined.

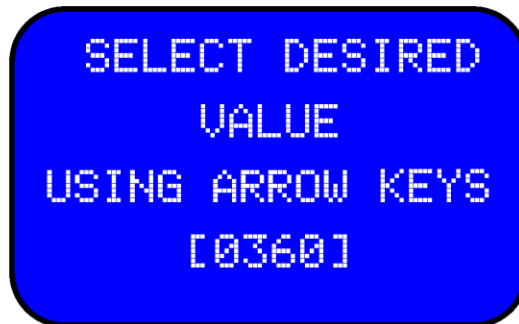

A confirmation message will be displayed confirming that desired operation was successfully executed.

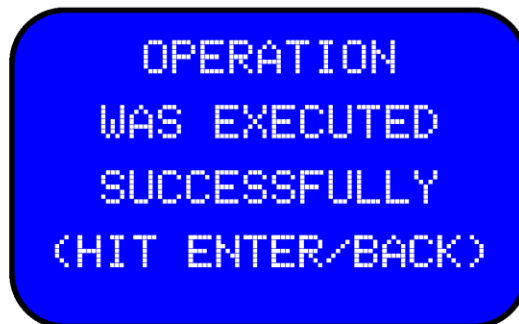

6.1.3.9 Serial number

Scroll to "**SERIAL NUMBER**" from "**NEW CHANNEL**" using the ▲▼ keys and press **ENTER**. "**SERIAL NUMBER**" can also be selected from "**EDIT CHANNEL**" to make modifications on the existing channels except channel one.

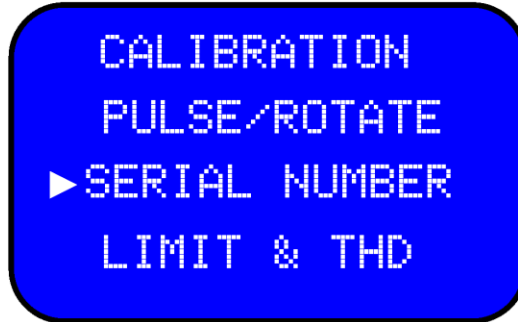

Using the ◀▶ keys, the cursor can be moved among the seven digits and use the ▲▼ keys to select the desired serial number.

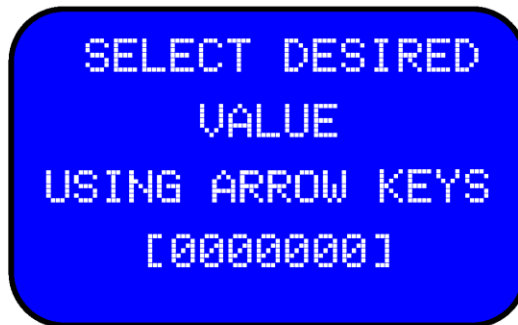

A confirmation message will be displayed confirming operation was successfully executed.

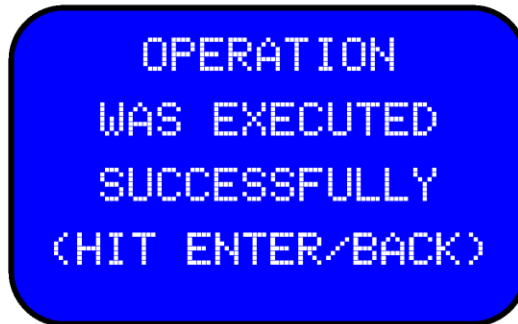

6.1.3.10 Limit & THD

Scroll to **LIMIT & THD** from “NEW CHANNEL” using the ▲ ▼ keys and press **ENTER.** **LIMIT & THD** can also be selected from “EDIT CHANNEL” to make modifications on the existing channels except channel one.

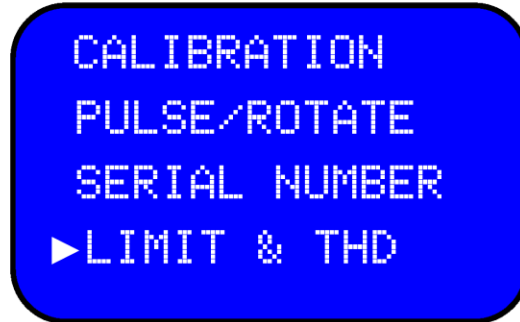

6.1.3.10.1 First Peak THD

Scroll to "FIRST PK THD" from "LIMIT & THD" using the ▲▼ keys and press ENTER.

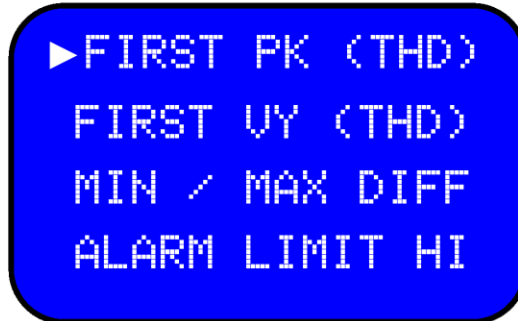

Use the arrow keys to move the cursor among the digits and select the desired number for the First Peak. The sign value can also be changed from positive to negative in case a bi-directional sensor is configured.



A confirmation message will be displayed confirming operation was successfully executed.

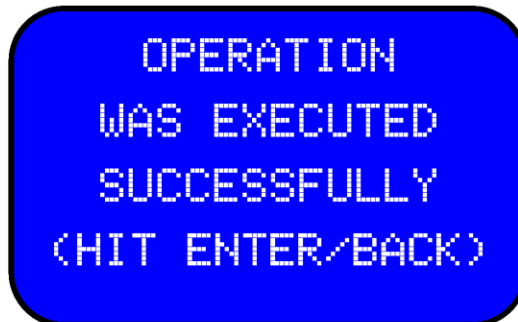

(See Figure no.1 and 2 on page 48 for examples of threshold levels on one directional and two directional sensors).

6.1.3.10.2 First Valley THD

Scroll to "FIRST VY (THD)" from "LIMIT & THD" using the ▲▼ keys and press ENTER.

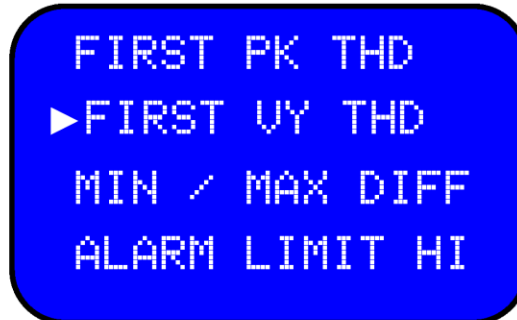

Use the arrow keys to move the cursor among the digits and select the desired number for the First Valley. The sign value can also be changed from positive to negative in case a bi-directional sensor is configured.



A confirmation message will be displayed confirming operation was successfully executed.

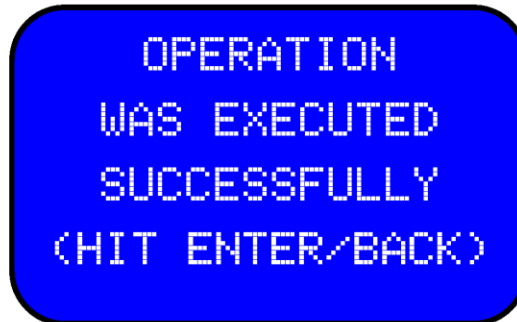

(See Figure no.1 and 2 on page 48 for examples of threshold levels on one directional and two directional sensors).

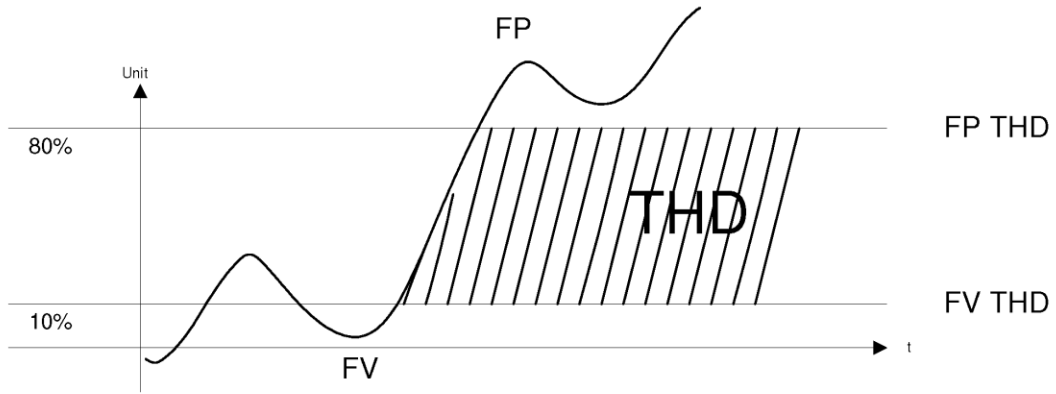

Figure No.1
Example of One Directional Sensor

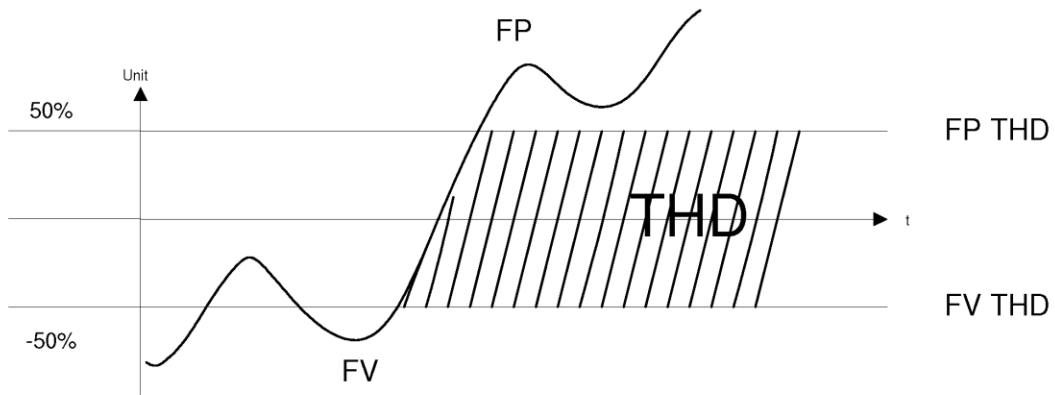
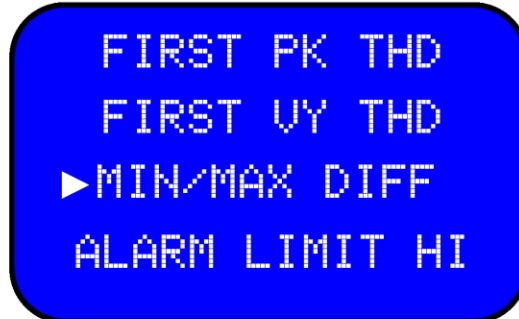

Figure No.2
Example of Two Directional Sensor

6.1.3.10.3 MIN/MAX Differentiation

Scroll to "MIN / MAX DIFF" from "LIMIT & THD" using the ▲ ▼ keys and press ENTER.



Use the arrow keys to move the cursor among the digits and select the desired number for the Min/Max Differentiations. The sign value can also be changed from positive to negative in case a bi-directional sensor is configured.



A confirmation message will be displayed confirming operation was successfully executed.

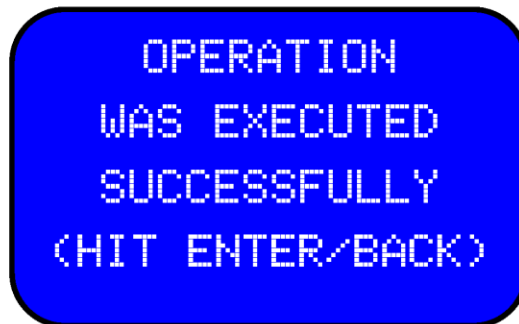

(See Figure no.3 on page 50 for examples of Min/Max Differentiation).

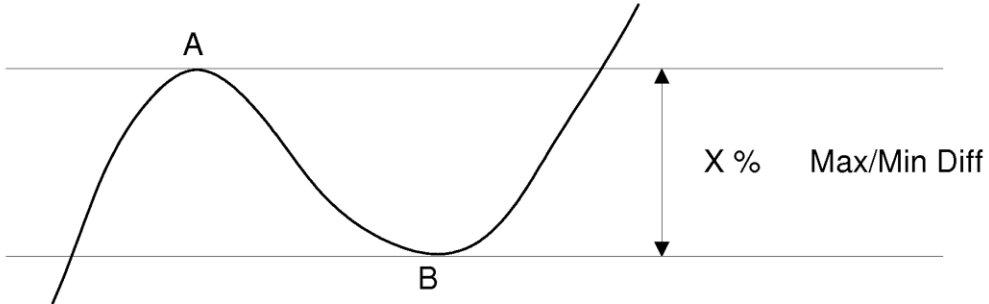

Figure No.3
Max/ Min Differentiation

Caution should be taken in defining X, for the Max/Min Diff.
For example:

Consider the following data at points A and B:

A: 100 IL

B: 90IL

If X is considered less than 10%, A would not be considered as first peak, or B would not be considered as first valley.

6.2.5 Peak/ Valley

Scroll to "PEAK/ VALLEY" from "SYSTEM SETTING" using the ▲▼ keys and press ENTER.

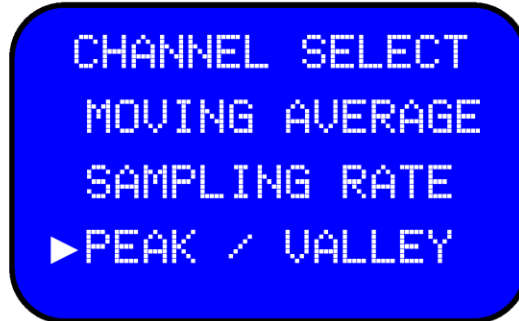

Using the ◀▶ keys select to display the First Peak/Valley or Hold Peak/Valley values.

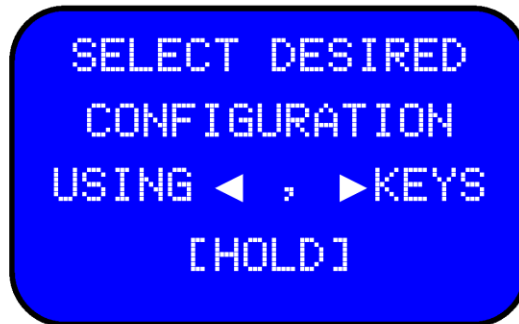

A prompt will be shown to set this value as a default setting.

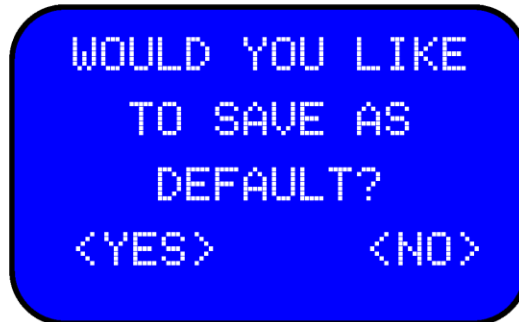

First Peak/First Valley mode will capture the first peak or valley and disregard the future inputs peak or valleys.
Peak Hold/Valley Hold mode will "Hold" on to the maximum (peak) and minimum (valley) values. First peak and first valley will be captured based on the specified threshold values defined in the sensor profile. Refer to sections (6.1.3.10.1), (6.1.3.10.2), and (6.1.3.10.3) for more details.

Valley is the maximum absolute value in the negative direction.

6.1.3.10.5 Alarm Limit Low

Scroll to "ALARM LIMIT LO" from "LIMIT & THD" using the ▲▼ keys and press ENTER.

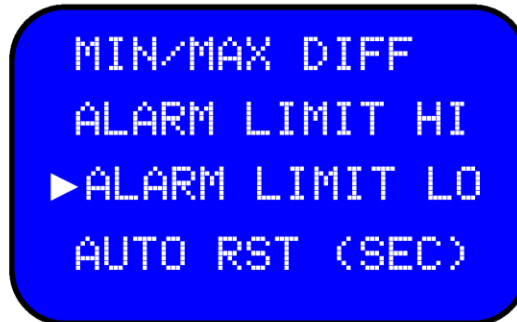

Use the arrow keys to move the cursor among the digits and select the desired number for the Alarm Limit Low. The sign value can also be changed from positive to negative in case a bi-directional sensor is configured.



A confirmation message will be displayed confirming operation was successfully executed.

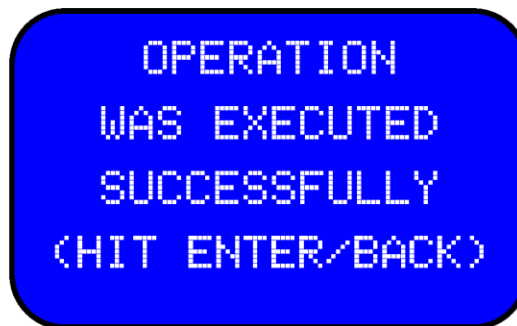

(See Figure no.4 and 5 on page 52 for examples of alarm threshold levels for one directional and two directional sensors).

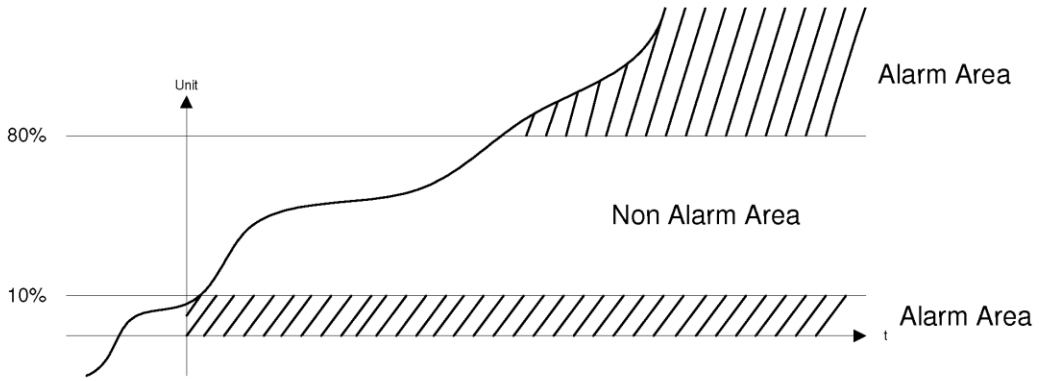

Figure No.4
Example of One Directional Sensor

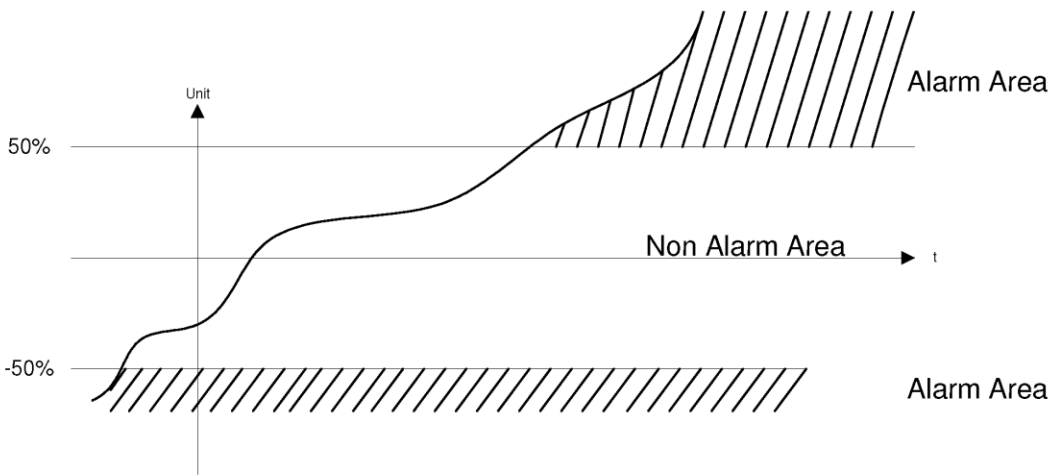
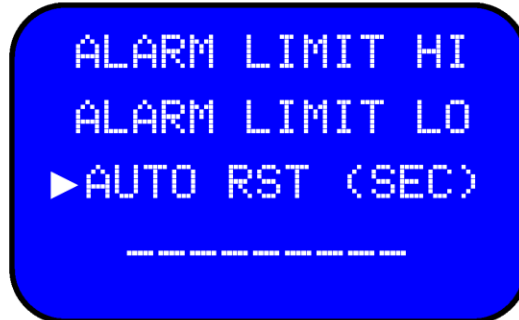

Figure No.5
Example of Two Directional Sensor

6.1.3.10.6 Auto Reset Timer

Scroll to "AUTO RST (SEC)" from "LIMIT & THD" using the ▲ ▼ keys and press ENTER.



Use the arrow keys to move the cursor among the digits and select the desired number.

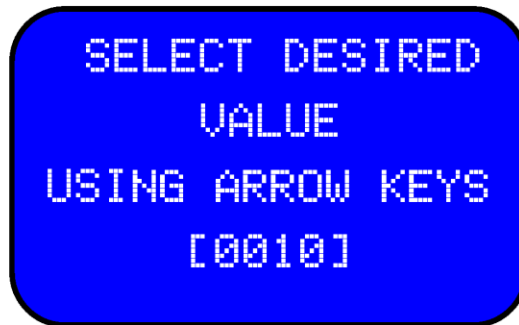

A confirmation message will be displayed confirming operation was successfully executed.

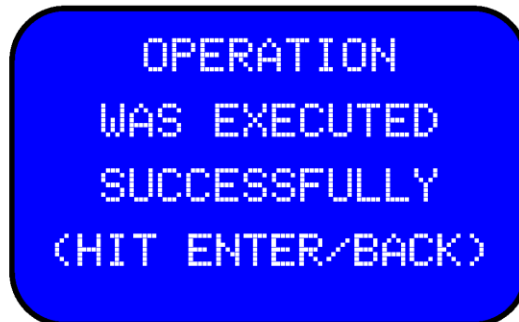

6.1.4 Edit Channel

Scroll to "EDIT CHANNEL" from "SENSOR PROFILE" using the ▲ ▼ keys and press ENTER.

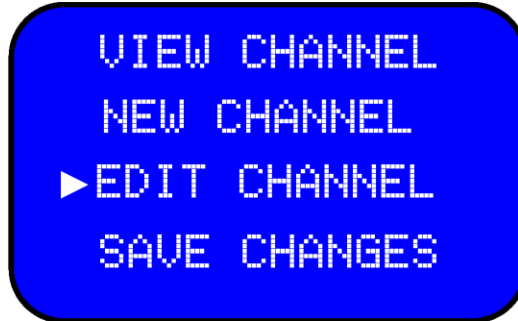

Attempting to edit channels when no channel has been set beside channel one, which was set by default, will result in the following warning:

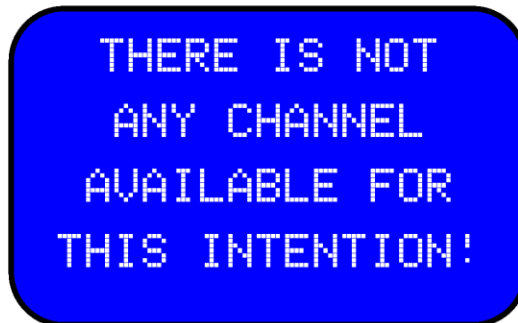

The edit channel option is not available if the lockout option is enabled. See section 6.7 for further information on lock settings how to enable or disable lock.

If this device is already locked the following message will be displayed "EDIT CHANNEL":



Use the ◀ ▶ to select the channel to edit.

SELECT DESIRED
CHANNEL NUMBER
USING ◀, ▶ KEYS
[02]

All the features that are accessible in the “New CHANNEL” option, applies to the Edit Channel option as well.

▶ SENSOR CONFIG
SENSITIVITY
UNIT SELECTION
SENSOR CAPACITY

PULSE / ROTATE
SERIAL NUMBER
▶ LIMIT & THD

6.1.4.1 Sensor Configuration

See the details mentioned on page 29 section 6.1.3.1.

6.1.4.2 Direction

See the details mentioned on page 30 section 6.1.3.2.

6.1.4.3 Unit selection

See the details mentioned on page 31 section 6.1.3.3.

6.1.4.3.1 Force (MASS)

See the details mentioned on page 32 section 6.1.3.3.1.

6.1.4.3.2 Torque

See the details mentioned on page 33 section 6.1.3.3.2.

6.1.4.3.3 Pressure

See the details mentioned on page 34 section 6.1.3.3.3.

6.1.4.3.4 Displacement

See the details mentioned on page 35 section 6.1.3.3.4.

6.1.4.3.5 mV/V

See the details mentioned on page 36 section 6.1.3.3.5.

6.1.4.4 Sensor Capacity

See the details mentioned on page 37 section 6.1.3.4.

6.1.4.5 Sensitivity (+)

See the details mentioned on page 38 section 6.1.3.5.

6.1.4.6 Sensitivity (-)

See the details mentioned on page 39 section 6.1.3.6.

6.1.4.7 Calibration

See the details mentioned on page 40 section 6.1.3.7.

6.1.4.7.1 Zero Load (+)

See the details mentioned on page 40 section 6.1.3.7.1

6.1.4.7.2 Full Scale (+)

See the details mentioned on page 41 section 6.1.3.7.2

6.1.4.7.3 Zero Load (-)

See the details mentioned on page 41 section 6.1.3.7.3

6.1.4.7.4 Full Scale (-)

See the details mentioned on page 41 section 6.1.3.7.4

6.1.4.8 Pulse per rotation

See the details mentioned on page 42 section 6.1.3.8.

6.1.4.9 Serial number

See the details mentioned on page 43 section 6.1.3.9.

6.1.4.10 Limit & THD

See the details mentioned on page 44 section 6.1.3.10.

6.1.4.10.1 First Peak (THD)

See the details mentioned on page 45 section 6.1.3.10.1.

6.1.4.10.2 First Valley (THD)

See the details mentioned on page 46 section 6.1.3.10.2.

6.1.4.10.3 MIN/MAX Differentiation

See the details mentioned on page 48 section 6.1.3.19.3.

6.1.4.10.4 Alarm Limit High

See the details mentioned on page 50 section 6.1.3.10.4.

6.1.4.10.5 Alarm Limit Low

See the details mentioned on page 51 section 6.1.3.10.5.

6.1.4.10.6 Auto Reset Timer

See the details mentioned on page 53 section 6.1.3.10.6.

6.1.5 Save Changes

Scroll to "SAVE CHANGES" from "SENSOR PROFILE" using the ▲▼ keys and press ENTER to save the modifications that are made under the Edit Channel or New Channel menu.

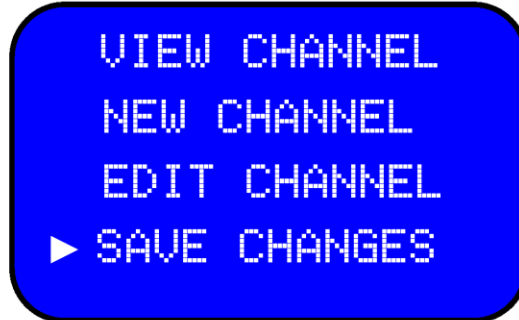

The Save Changes option is not available if the lockout option is enabled. See section 6.7 for further information on lock settings. If this device is already locked the following message will be displayed.

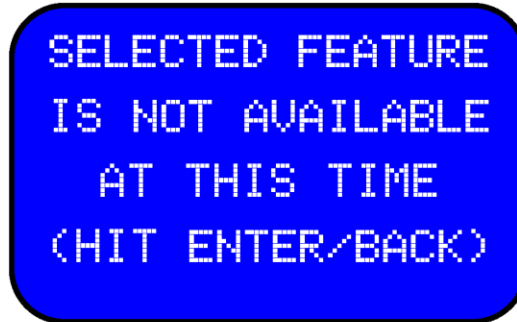

Once a new channel is saved or modifications on the existing channel are saved, the new profile will be loaded. The previous profile cannot be re-loaded.

Anytime that a new sensor sensitivity is set or the sampling rate is changed, the device may do an auto calibration after it loads the new profile.



The following confirmation message will be displayed:

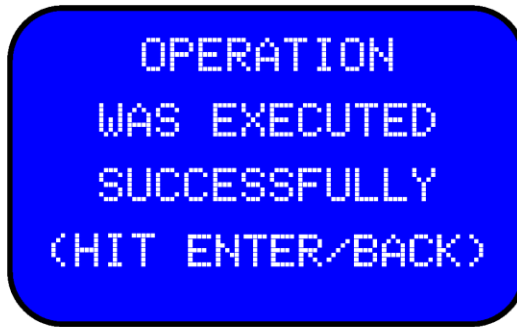

If the sensitivity of the new channel configuration or the modification is unchanged, a message confirming that the desired operation was successfully executed will be given.

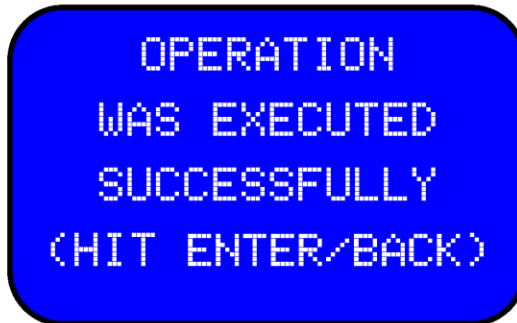

6.1.6 Delete Channel

Scroll to "DELETE CHANNEL" from "SENSOR PROFILE" using the ▲ ▼ keys and press **ENTER**. Use the ◀ ▶ keys to select the channel to delete. Choose Accept or Cancel to confirm or cancel the operation.

Note: Any channel other than the first channel can be deleted.

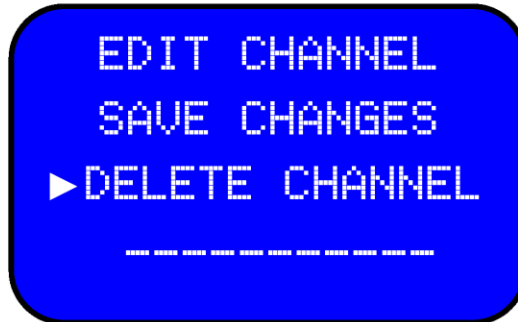

Attempting to delete channels when no channel has been set, besides channel one which is set by default, will result in the following warning message.

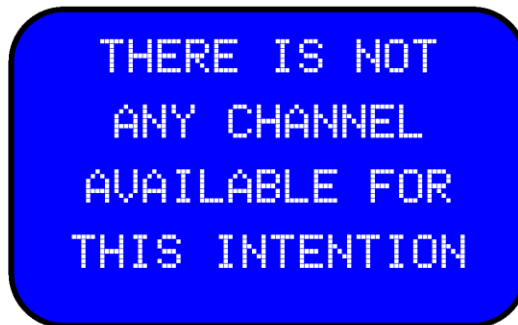

If the channel chosen to be deleted is already set as active channel, the following message will be given:

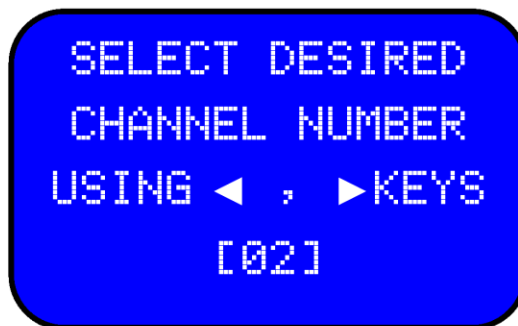

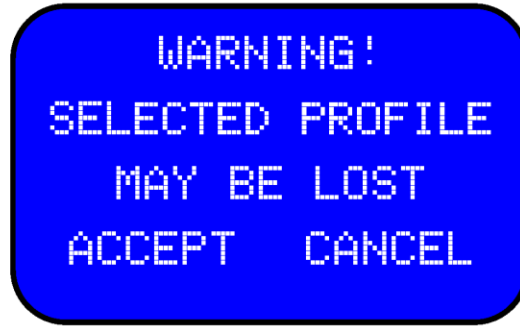
A blue rounded rectangular screen with white text. The text reads: "WARNING!
SELECTED PROFILE
MAY BE LOST
ACCEPT CANCEL".

WARNING!
SELECTED PROFILE
MAY BE LOST
ACCEPT CANCEL

A message confirming the desired operation was successfully executed will be displayed.

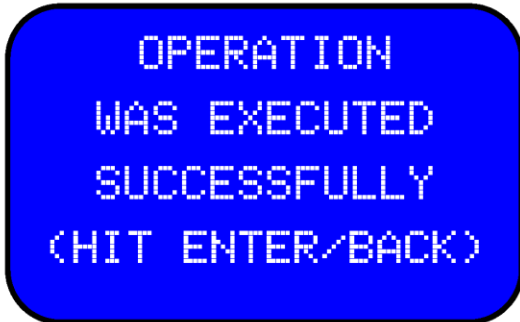
A blue rounded rectangular screen with white text. The text reads: "OPERATION
WAS EXECUTED
SUCCESSFULLY
(HIT ENTER/BACK)".

OPERATION
WAS EXECUTED
SUCCESSFULLY
(HIT ENTER/BACK)

If the channel attempting to delete is the active channel, the following message will be displayed:

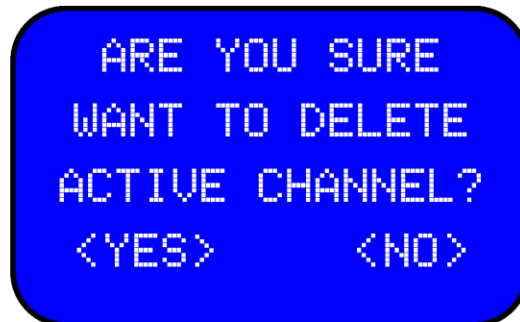
A blue rounded rectangular screen with white text. The text reads: "ARE YOU SURE
WANT TO DELETE
ACTIVE CHANNEL?
<YES> <NO>".

ARE YOU SURE
WANT TO DELETE
ACTIVE CHANNEL?
<YES> <NO>

If the active channel is deleted, profile one will be automatically loaded, and an auto calibration will take place.

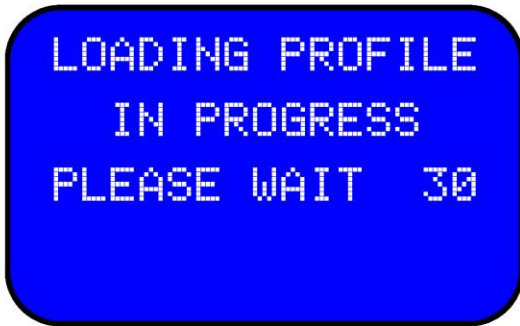

BACK can be applied to cancel or **ENTER** can be used to delete the selected channel. Once accepted to delete, a message confirming the desired operation was successfully executed will be given:

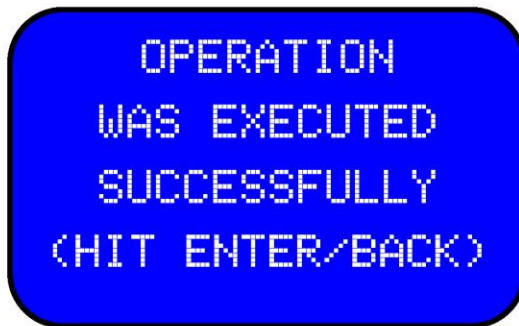

The delete function is not available if the lockout option is enabled. If this device is already locked, attempting to select "DELETE CHANNEL" will produce the following message:



Refer to section 6.7 for lock settings and for further information how to set it enable or disable.

6.2 System Setting

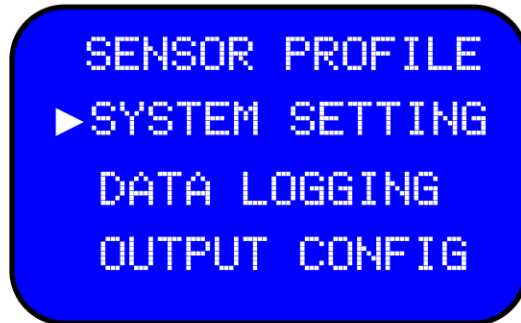
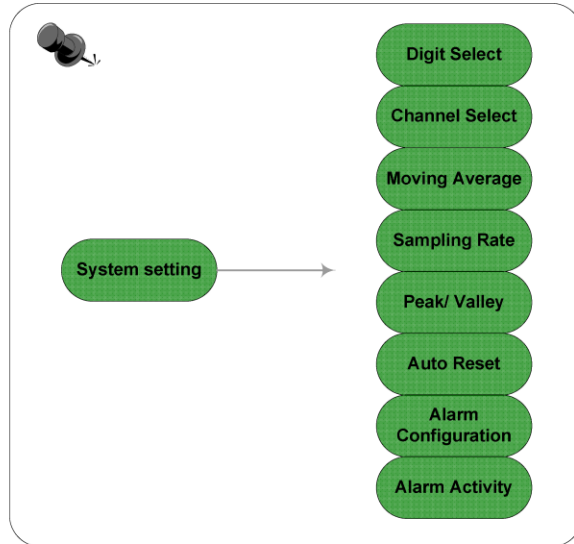

6.2.1 Digit Select

Scroll to "DIGIT SELECT" from "SYSTEM SETTING" using the ▲▼ keys and press ENTER.

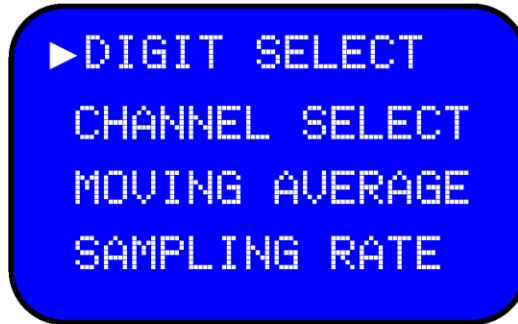

Use the ◀▶ keys to select the number of digits from 3 to 6.



Once the desired number of digits has been selected, a prompt will appear prompting to set the value as a default value.

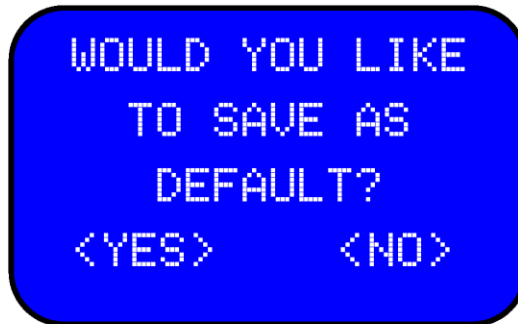

Select EXIT to return to the main page at any time.
Press BACK to go to the previous options at any time.

6.2.2 Channel Select

Scroll to "CHANNEL SELECT" from "SYSTEM SETTING" using the ▲▼ keys and press ENTER. Use the ◀▶ keys to select the desired number. If no other channels have been added, only channel 01 can be selected, which is the default channel.

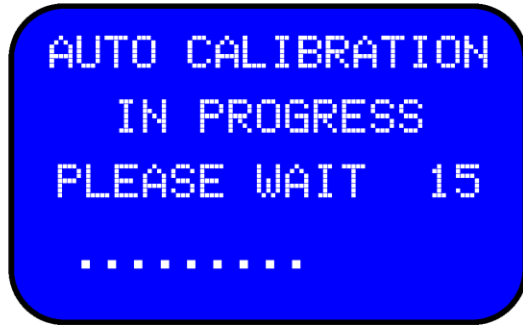
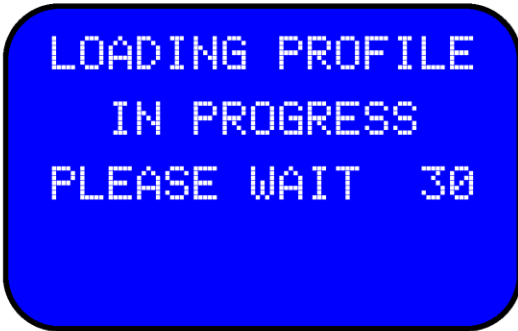

After selecting the desired channel, there is the option of setting it as the default channel. Use **BACK** to select NO and return to the system setting option. By selecting YES, the selected channel will be set as the default channel.

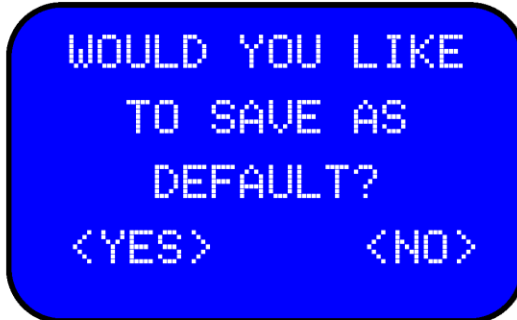

6.2.3 Moving Average

Scroll to **"MOVING AVERAGE"** from **"SYSTEM SETTING"** using the ▲ ▼ keys and press **ENTER**.
Using the ◀ ▶ keys: **disable, 2, 4, 8, 16, 32, 64, or 128** can be selected.

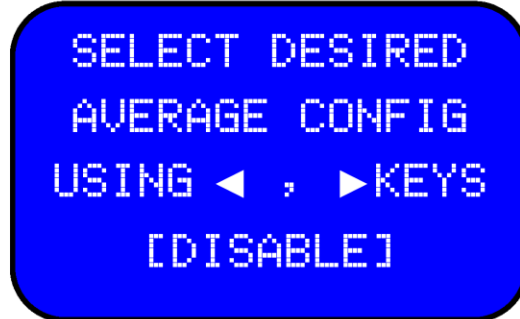

After selecting the desired moving average settings, a prompt will be shown with the option of setting it as default. Use **BACK** to select NO and return to the system setting option. By selecting YES, the selected channel will be set as the default channel.

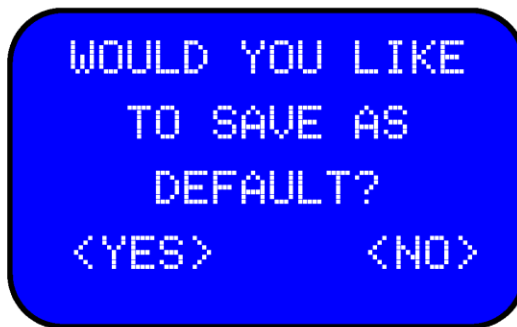

Average Measurements:

An average (Ave_n) is defined as the summation of n samples divided by n.

$$Ave_n = \frac{\sum_{i=1}^n \text{Sample}_i}{n} \tag{1}$$

For the k^{th} average, we have the following:

$$Ave_k = \frac{\sum_{i=1+k-n}^k \text{Sample}_i}{n} \tag{2}$$

This is known as a moving average because the average at each k^{th} instant is based on the most recent set of n values. In other words, it is a moving window of n values that are used to calculate the average of the data sequence (see Figure 1).

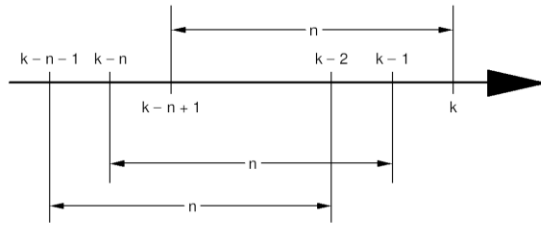

Figure 1. Moving Average of n Data Points

The averaging process can be improved if the calculations can be performed in a recursive fashion. Equation 1 can also be represented as the previous total of $n - 1$ samples plus the new sample, and then divided by n .

$$Ave_n = \frac{\sum_{i=1}^{n-1} Sample_i + Sample_n}{n} \quad (3)$$

Using Equation 1, we can derive the equation for Ave_{n-1}

$$Ave_{n-1} = \frac{\sum_{i=1}^{n-1} Sample_i}{n-1} \quad (4)$$

This can be rearranged as shown in Equation 5:

$$(n-1) \cdot Ave_{n-1} = \sum_{i=1}^{n-1} Sample_i \quad (5)$$

Using Equation 5, we can replace the value of $\sum_{i=1}^{n-1} Sample_i$ in equation 3 with $(n-1) \times Ave_{n-1}$. This yields Equation 6:

$$Ave_n = \frac{(n-1) \cdot Ave_{n-1} + Sample_n}{n} = \frac{n \cdot Ave_{n-1} - Ave_{n-1} + Sample_n}{n} \quad (6)$$

Equation 6 can be simplified to equation 7:

$$Ave_n = Ave_{n-1} + \frac{Sample_n - Ave_{n-1}}{n} \quad (7)$$

6.2.4 Sampling Rate

Scroll to “**SAMPLING RATE**” from “**SYSTEM SETTING**” using the ▲▼ keys and press **ENTER**. Using the ◀▶ keys, 16 different sampling rates can be selected in two different levels as listed below:

LOW SPEED: 5, 10, 25, 30, 50, 60, 100, 200, 400
HIGH SPEED: 600, 800, 960, 1200, 1600, 2400, 4800

Note: During the data logging, *Voltage output*, *Current output*, and *ASCII output* are disabled to get the maximum data.
See section 6.3 for more information about data logging.

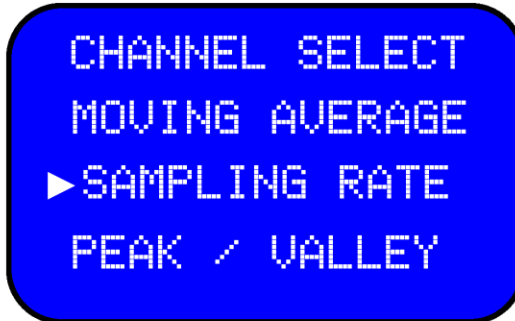

Whenever the sampling rate is changed the system will automatically load the active channel and perform an auto calibration followed by loading the active channel information.

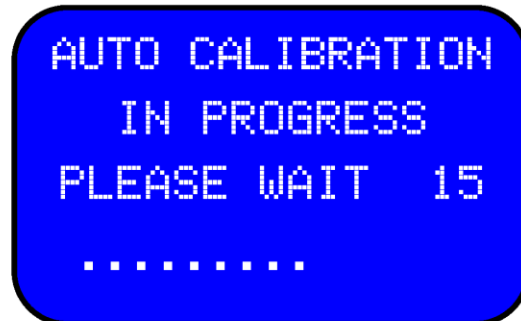
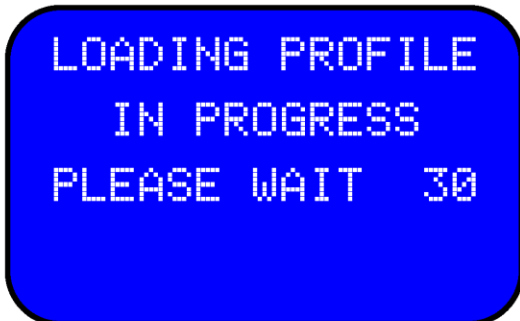

For bandwidth clarification see APPENDIX C (DEVICE SPECIFICATIONS) on page 119

6.5.2 ASCII output

Scroll to "ASCII OUTPUT" from "INTERFACE" using the ▲▼ keys and press ENTER.

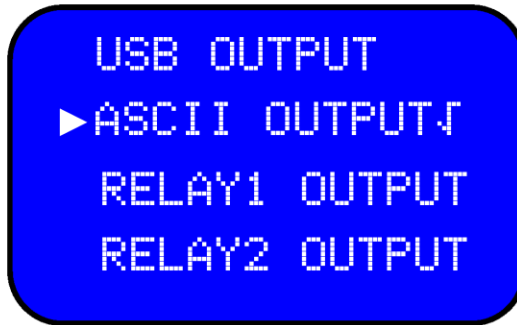

Use the ◀▶ keys to either enable or disable the ASCII output. The termination character configuration should be set in the Digital ASCII menu within the Output Config menu. Refer to section (6.4.1) for more details.

The ASCII output is disabled when the IHH500 sends and receives packet information from the computer.

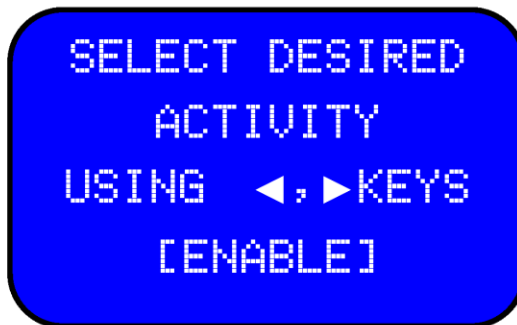

A prompt will be shown to set this value as a default setting.

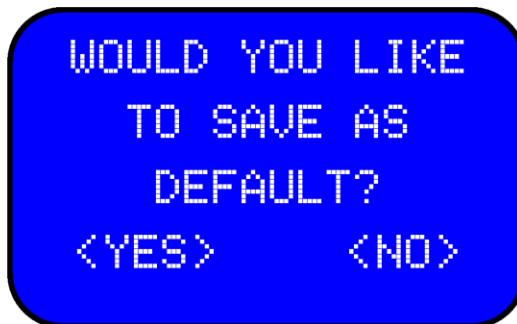

Whenever the ASCII Output is enabled a check mark showing that this feature is enabled will be seen on the display.

6.2.6 Auto Reset

Scroll to "AUTO RESET" from "SYSTEM SETTING" using the ▲▼ and press ENTER.

Auto Reset will reset the peak and valley values when the timer is expired. The time, in seconds, is defined in the sensor profile. Refer to section (6.1.4.10.6) for more detail.



Using the ◀▶ keys select to enable or disable the Auto Reset function.

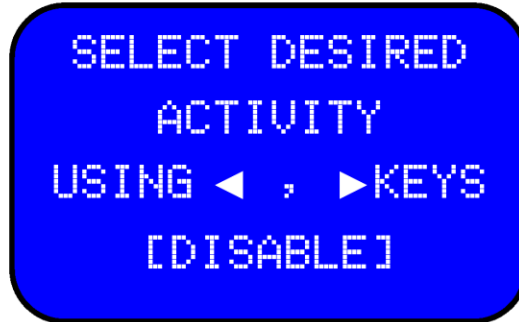

A prompt will be shown to set this value as a default setting.

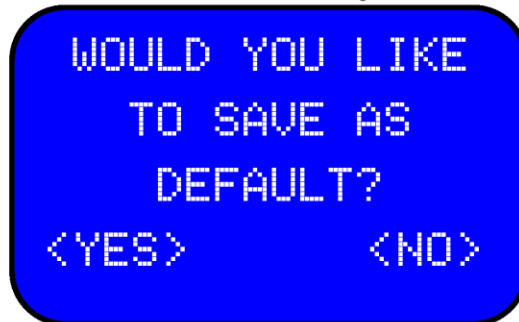

6.2.7 Alarm Configuration

Scroll to "**ALARM CONFIGURATION**" in "**SYSTEM SETTING**" using the ▲ ▼ keys and press **ENTER**.

The Alarm threshold levels are set in the sensor profile (Refer to section 6.1.3.10), Refer to the drawings on page 52 for examples regarding alarm THD levels.



Using the ◀▶ keys set the Alarm Configuration to Latched or Non-Latched.

Definitions:

Latch alarm: Holds the alarm activated until a reset function (manual reset or auto reset) is performed.

Non-Latched alarm: The alarm will turn OFF if the current value goes outside the alarm operating range (enters none alarm area).

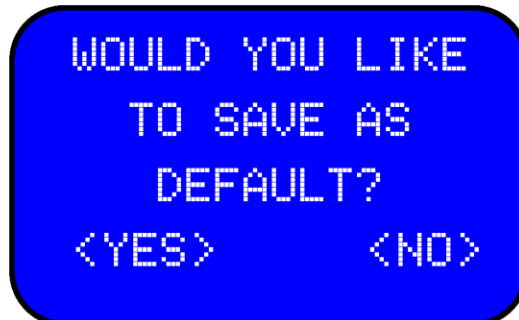
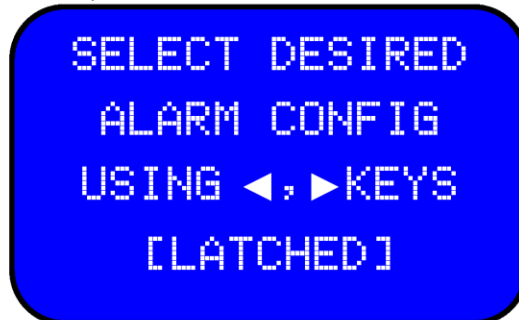

6.2.8 Alarm Activity

Scroll to "**ALARM ACTIVITY**" from "**SYSTEM SETTING**" using the ▲▼ keys and press **ENTER**.



Using the ◀▶ keys different alarm activities including System Alarm or Relay Alarm can be either enabled or disabled.

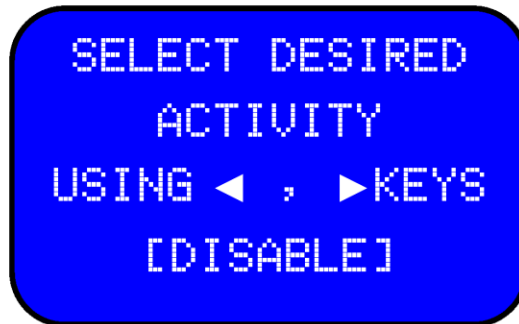

A prompt will be shown to set this value as a default setting.

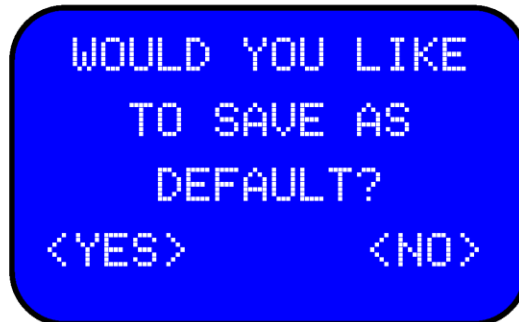

The Peak values will blink in intervals of 2.5 seconds if the current value exceeds the alarm high limit. The Vally values will blink in intervals of 2.5 seconds if the current value is below the alarm low limit.

6.3 Data Logging

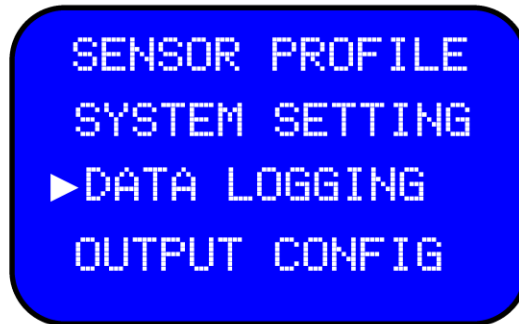
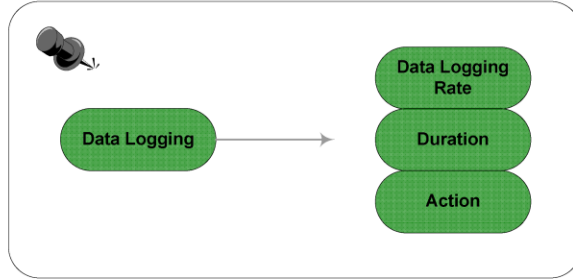

This menu option allows the user to log the data. Data logging is a useful feature to monitor the performance of sensor during a specific time. In order to take advantage of this feature the following factors should be considered before:

The Data Logging feature is not available if the timer has been expired or there is not enough memory location to support the defined time. Also if there is an attempt to try to use the Tare key while using this feature, a warning message will notify the user that this function is not available at this time.

IHH500 has 128 Kbytes internal buffer to log the data. This buffer has been partitioned to two areas for Tracking and Time values and each category has 24 bit data (3 bytes) allocated to it; which means that each one has capacity of 21,845 pieces of data. The final data packet time, is measured in millisecond. After data logging is completed, while the device is on and another data logging has not been established, the logged data is accessible by FUTEK data logging software, SensIT Instrument.

Note: Encoder information is not monitored during a data logging session.

6.3.1 Logging Rate

Scroll to "**LOGGING RATE**" from "**DATA LOGGING**" using the ▲▼ keys and press **ENTER**. Using the ◀▶ keys select either **HALF SPEED**, **FULL SPEED**. This setting can be set as a default setting.

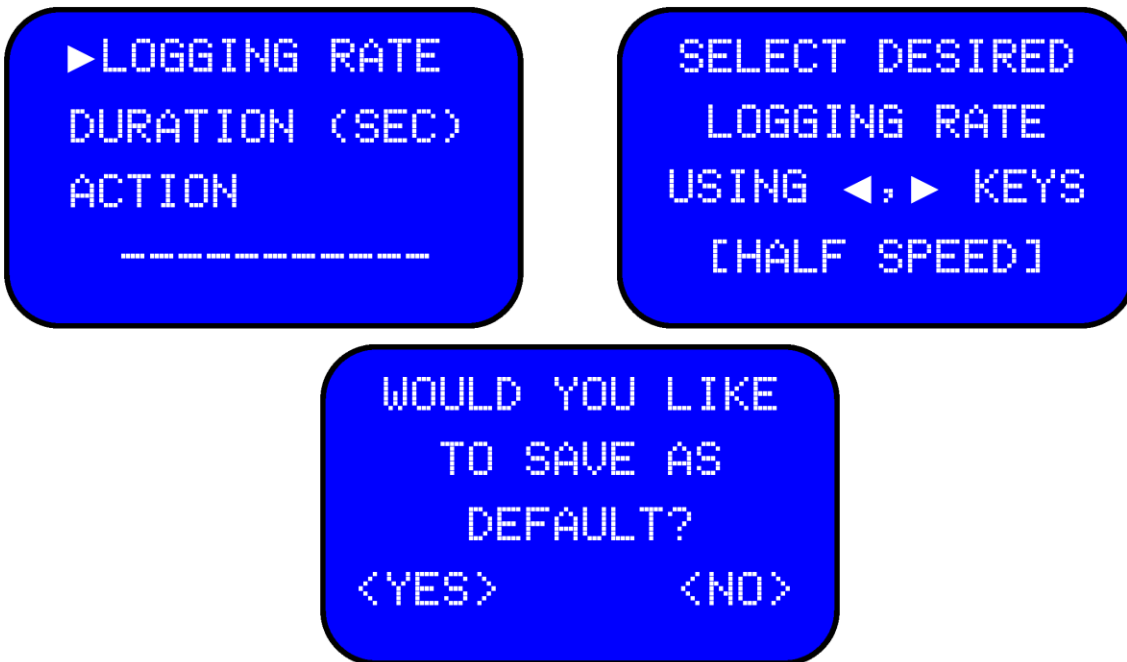

At full speed the IHH500 will use the current set sampling rate in the data logging session. At half speed, 1/2 of the current set sampling rate will be using in the data logging session.

6.3.2 Duration (SEC)

Scroll to "DURATION" from "DATA LOGGING" using the ▲▼ keys and press ENTER.
Use the ◀▶ and the ▲▼ keys to select the desired duration in seconds; therefore, from 0 to 9999 seconds can be selected.

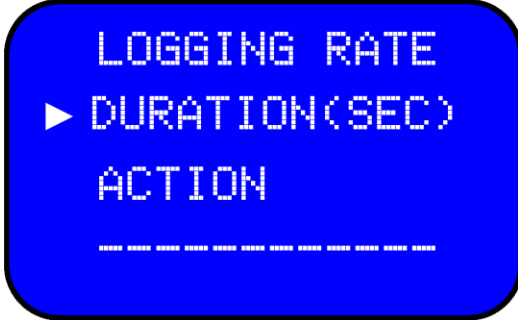

Note: The duration that can be set is limited by the following formula:

$$\text{Max Duration (sec)} = \text{Integer } (21845 / \text{ sampling rate})$$

SPS	5	10	25	30	50	60	100	200
Max D	4369	2184	873	728	436	364	218	109

SPS	400	600	800	960	1200	1600	2400	4800
Max D	54	36	27	22	18	13	9	4

For example:

If the sampling rate has been set to 10 Samples per Second (SPS) the duration, in second, can be selected up to 2184.

In the case of HALF SPEED the duration time can be twice as long.

If the device has been set to 10 Samples per Second (SPC) and HALF SPEED logging rate is selected, the duration, in second, can be selected up to 4368.

Although any other numbers can be selected, after the actual maximum duration time, the internal buffer will hit full capacity and the following message will appear:

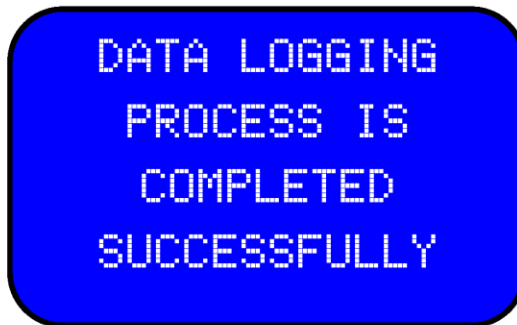

6.3.3 Action

Scroll to "ACTION" from "DATA LOGGING" using the ▲▼ keys and press ENTER. Using the ◀▶ keys, the data logging session either can be started or stopped. This sub menu allows the user to Stop or Start data logging process. As soon as the Start option is selected, the data logging process starts.

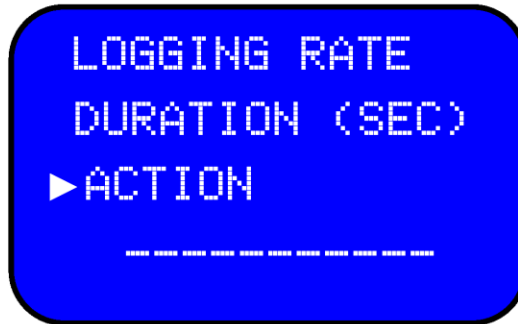

By pressing the ENTER key you can select to stop or start the data logging test.



The following check mark will be displayed when the data logging session has begun.

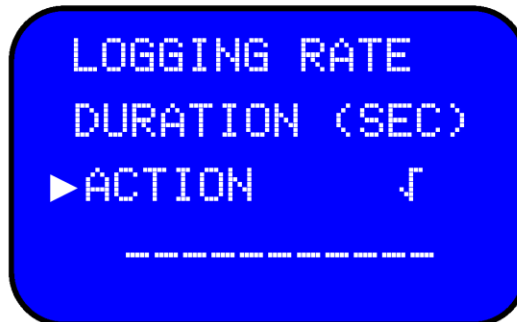

It is important to know that IHH500 is equipped by a high speed Processor. This processor is responsible to control every single feature of device and dedicates the specific time frame for internal operation and Interfaces. During a high speed data logging session (600, 800, 960, 1200, 1600, 2400 and 4800) the *Voltage output*, *Current output*, and *ASCII output* are internally disabled and the data logging menu cannot be left until the timer expires. This will force the processor to allocate more time frames to process the data from ADC, perform the calculation, and save the data into the internal buffer, however after completing the data logging session, the initial conditions will be restored.



HIGH SPEED
DATA LOGGING
IN PROGRESS
PLEASE WAIT

When performing data logging session at lower speed sampling rates below 600 sps, there is an option to exit the data logging screen and return to the main screen where the countdown timer shows the elapsed time.

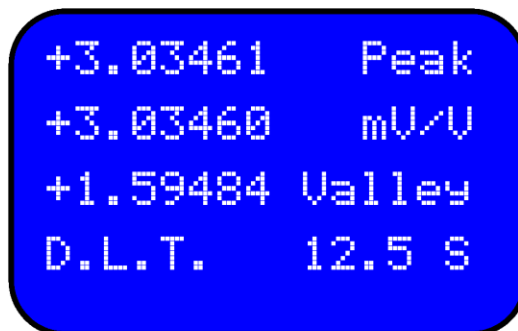

+3.03461 Peak
+3.03460 mU/U
+1.59484 Valley
D.L.T. 12.5 S

The following message will be displayed as soon as the data logging session has been completed.

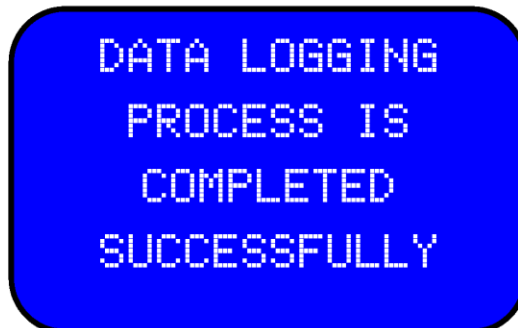

DATA LOGGING
PROCESS IS
COMPLETED
SUCCESSFULLY

6.4 Output Configuration

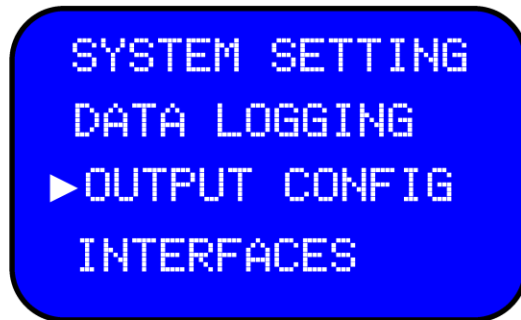
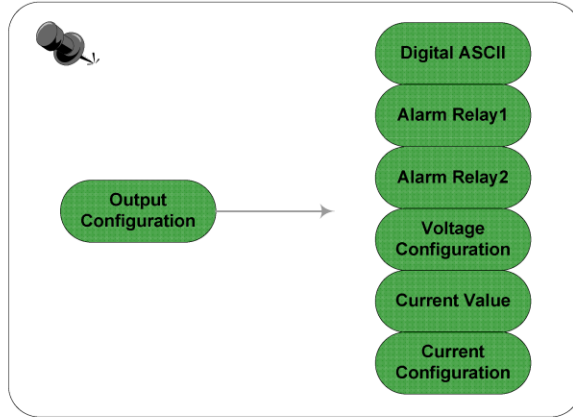

6.4.1 Digital ASCII

Scroll to "DIGITAL ASCII" from "OUTPUT CONFIG" using the ▲▼ keys and press ENTER.

ASCII output consists of four rows of data. Each row can be separated using following options:

- Carriage Return: carriage return (CR) is one of the control characters in ASCII code which moves the position of the cursor to the first position on the same line
- Line feed: moves the cursor on a display screen down one line.
- Carriage Return and line feed: moves to the next line, while carriage return precedes line feed to indicate a new line.
- Line feed and Carriage Return

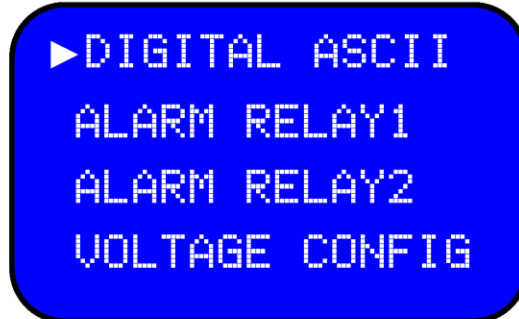

Use the ◀▶ keys and press ENTER to select either CR, LF, LF & CR or LF & CR.

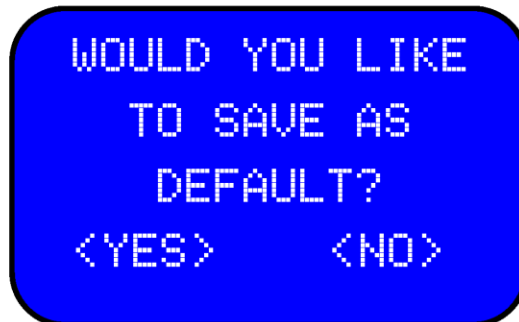

6.4.2 Alarm Relay 1

Alarm relay 1 is a solid state relay with a voltage / current rating of 110V/100mA. Alarm relay 1 has been mapped to alarm high. See section (6.2.8) to enable or disable alarm relay 1.

Scroll to “ALARM RELAY1” from “OUTPUT CONFIG” using the ▲ ▼ keys and press ENTER. Use the ◀ ▶ keys to set the alarm relay 1 either to be normally open or normally close.

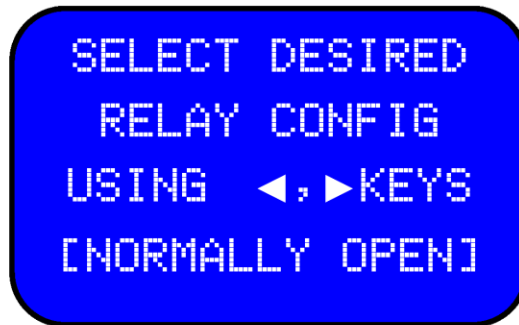
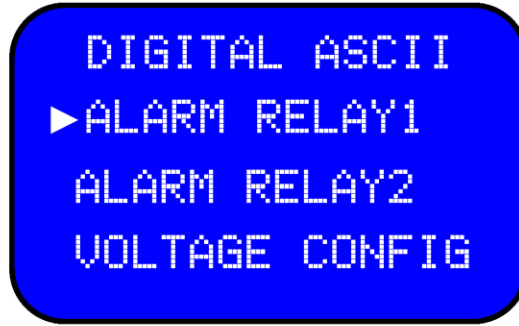

A prompt will be shown to set this value as a default setting.

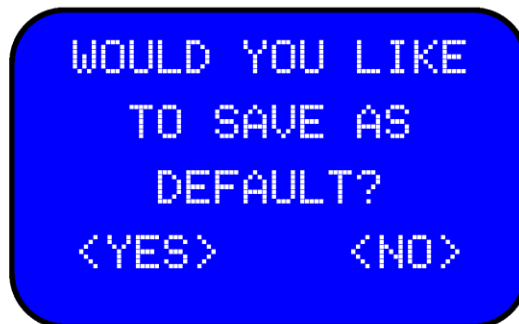

6.4.3 Alarm Relay 2

Alarm relay 2 is a solid state relay with a voltage / current rating of 110V/100mA. Alarm relay 2 has been mapped to alarm high. See section (6.2.8) to enable or disable alarm relay 2. Scroll to "ALARM RELAY2" from "OUTPUT CONFIG" using the ▲ ▼ keys and press ENTER. Use the ◀ ▶ keys to set the alarm relay 2 either to be normally open or normally close.

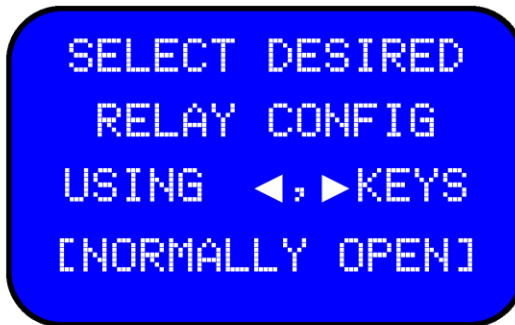
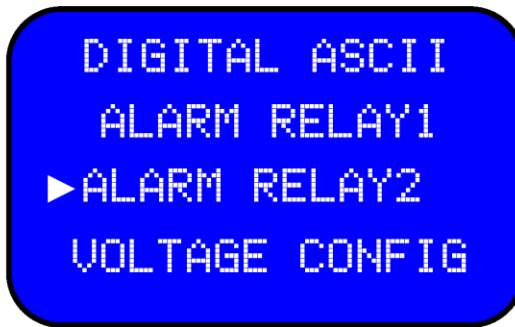

A prompt will be shown to set this value as a default setting.

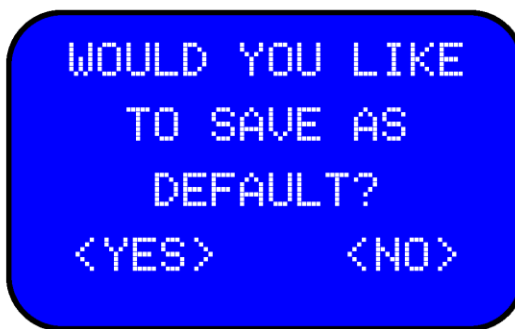

6.4.4 Voltage Configuration

Scroll to "VOLTAGE CONFIG" from "OUTPUT CONFIG" using the ▲▼ keys and press ENTER.

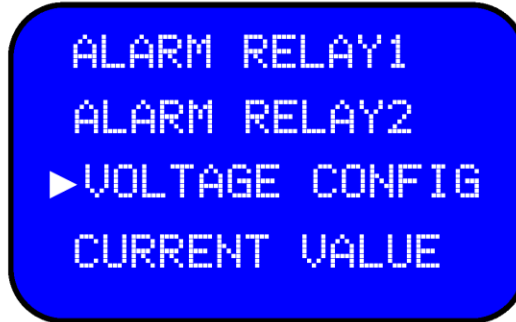

Use the ◀▶ keys to select uni-polar which is 0 to 5 volts (negative full scale is mapped to 0 VDC, zero load is mapped to 2.5 VDC and plus full scale is mapped to +5V) or bipolar which is -5 VDC to 5 VDC (negative full scale is mapped to -5 VDC, zero load is mapped to 0 VDC and plus full scale is mapped to +5VDC).

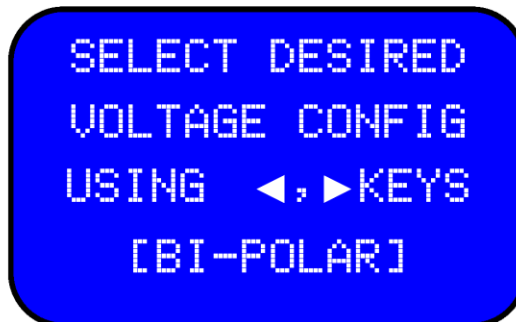

A prompt will be shown to set this value as a default setting.

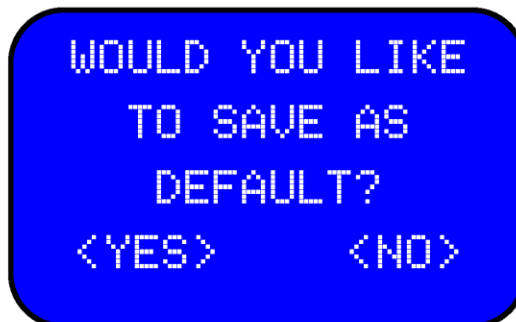

6.4.5 Current Value

Scroll to "CURRENT VALUE" from "OUTPUT CONFIGURATION" using the ▲▼ keys and press ENTER to define the current value.

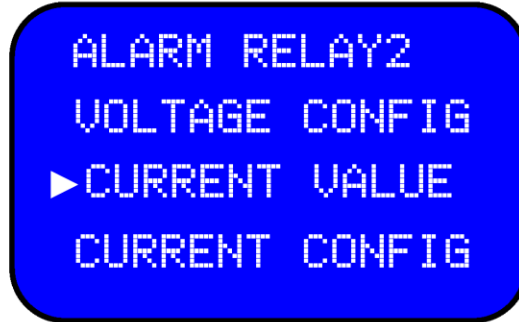

Use the ◀▶ keys and press ENTER to select any of the following Ranges: 0-20 mA, 4-20 mA, 0-25 mA or 5-25 mA.

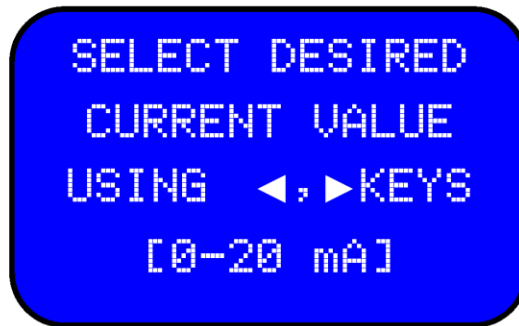

A prompt will be shown to set this value as a default setting.

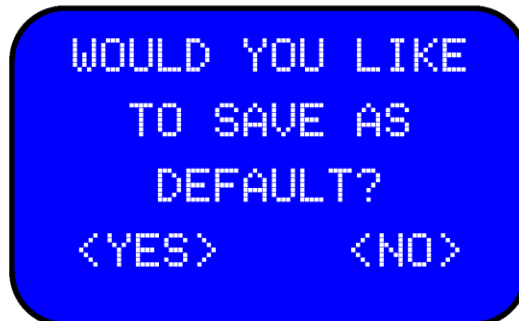

6.4.6 Current Configuration

Scroll to “**CURRENT CONFIG**” from “**OUTPUT CONFIG**” using the ▲ ▼ keys and press **ENTER**. Use the ◀ ▶ keys to select either **UNIDIRECTIONAL** or **BIDIRECTIONAL**

- For a Bi-Directional configuration the, negative full scale output from the sensor is mapped to the lowest value of current. A zero load output from the sensor is mapped to the middle value and the positive full scale output from the sensor is mapped to the highest value of current. For example if 4-20 mA is selected, the sensor’s negative full scale output is mapped to 4 mA, the zero load output from the sensor is mapped to 12 mA, and the sensor positive full scale output is mapped to 20 mA.

This configuration is recommended for bidirectional sensors.

- For a Unidirectional configuration, the zero load output from the sensor is mapped to the lowest value of current and the sensor’s positive full scale output is mapped to the highest value of current. For example if 4-20 mA is selected, the zero load output from the sensor is mapped to 4 mA, and sensor’s positive full scale output is mapped to 20 mA. For negative values of load, output current decreases until reach 0 mA.
- This configuration is recommended for unidirectional sensors in order to obtain more resolution.

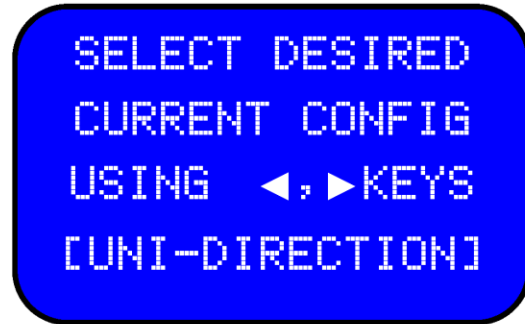

A prompt will be shown to set this value as a default setting.

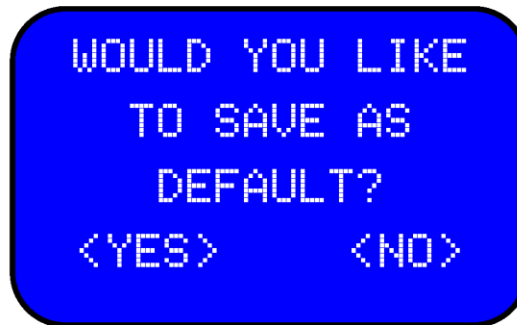

6.5 Interfaces

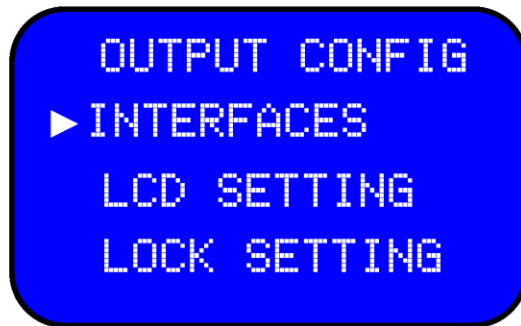
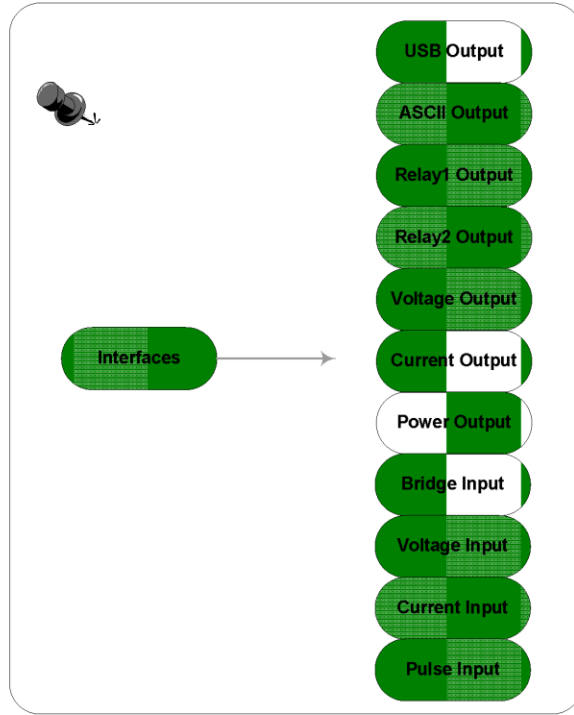

The following can be either enabled or disabled under the Interfaces menu:

USB output, ASCII output, Relay 1 output, Relay 2 output, voltage output, current output, power output, Bridge input, Voltage input, Current input and pulse input. A check mark next to the item indicates that item has been activated.

Output enable: This feature enables a 24 V/1W power supply to be used as an excitation voltage (power supply) for an amplified sensor which requires an external power supply. It is highly recommended to disable this feature when a bridge type sensor is connected to the IHH500.

Using this feature will enable the internal DC-DC converter, thus providing high voltage. It should be noted that the battery life discharges faster when working with amplified sensors.

6.5.1 USB Output

Scroll to "USB OUTPUT" from "INTERFACE" using the ▲ ▼ keys and press ENTER.

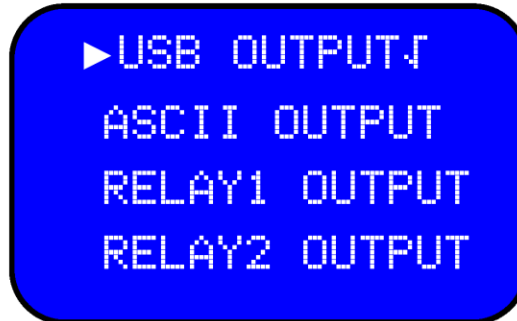

Use the ◀ ▶ keys to either enable or disable the USB output activity.

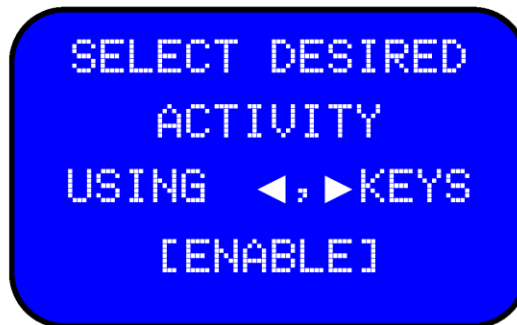

A prompt will be shown to set this value as a default setting.

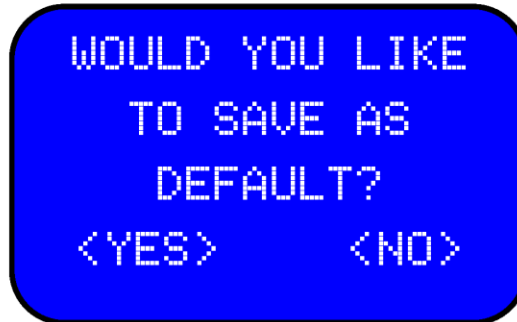

Whenever the USB Output is enabled a check mark showing that this feature is enabled will be seen on the display.

6.8 TEDS Data

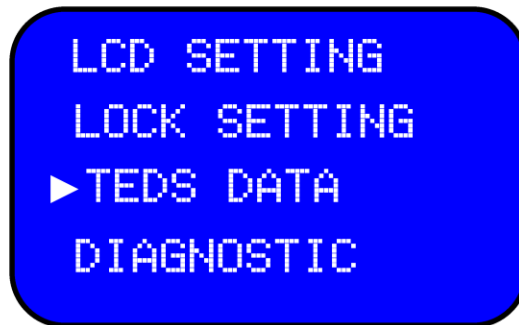
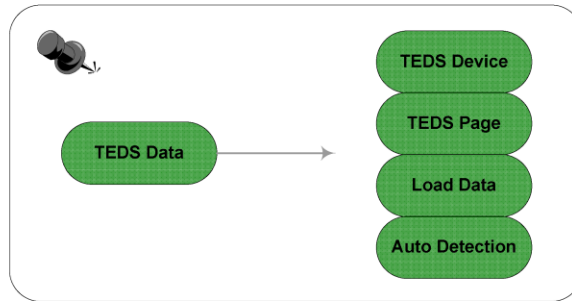

The mentioned IEEE 1451.4 standard defines a collection of templates for common class transducer. The templates provide the means for the measurement system to convert the binary data stored on a smart TEDS sensor EEPROM.

The IHH 500 supports Template 30 for High level voltage output sensors and template 33 for bridge type sensors.

Transducers with stated template for different chip devices (DS2430, DS2431, DS2432 and DS2433) are supported with IHH500.

List of probable error while using TEDS:

Please see Appendix A

6.5.3 Relay 1 Output

Scroll to "RELAY1 OUTPUT" from "INTERFACE" using the ▲▼ keys and press ENTER.

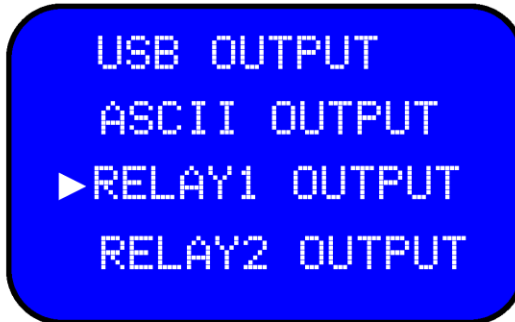

Use the ◀▶ keys to enable or disable Relay 1 output.

The configuration of the Relay 1 Output should be set under the output configuration menu. Refer to section (6.4.2) for more details.

Relay 1 is mapped to alarm high and will be affected by the alarm settings under the system setting menu. Refer to section (6.2.8) for more details on alarm activity.

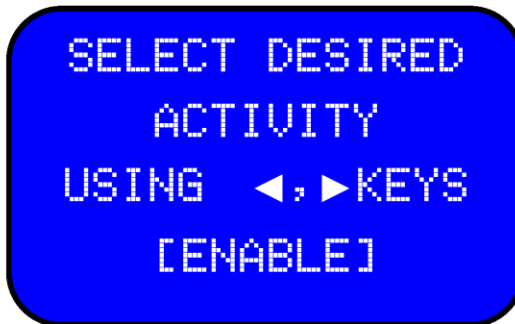

A prompt will be shown to set this value as a default setting.

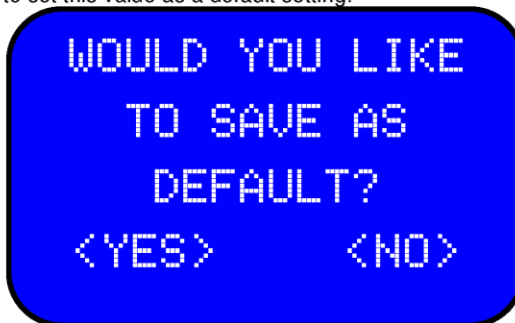

Whenever the Relay 1 Output is enabled a check mark showing that this feature is enabled will be seen on the display.

6.5.4 Relay 2 Output

Scroll to "RELAY OUTPUT2" from "INTERFACE" using the ▲▼ keys and press ENTER.

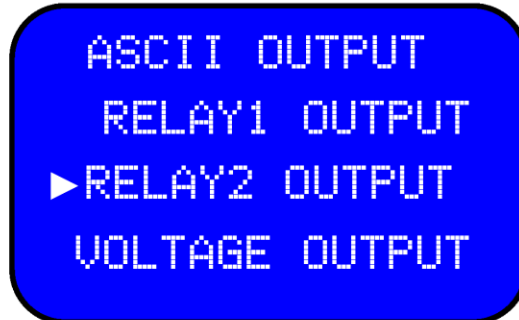

Use the ◀▶ keys to either disable or enable the Relay 2.

The configuration of the Relay 2 Output should be set under the output config menu. Refer to section (6.4.3) for more details.

Relay 2 is mapped to alarm low and will be affected by the alarm settings under the system settings menu. Refer to section (6.2.8) for more details.

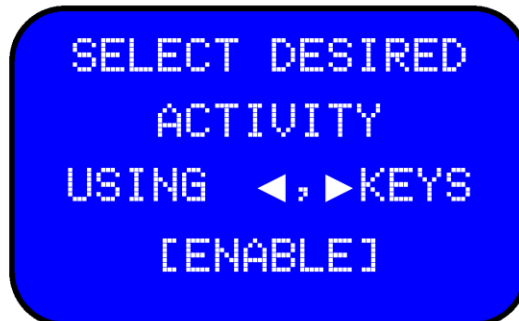

A prompt will be shown to set this value as a default setting.

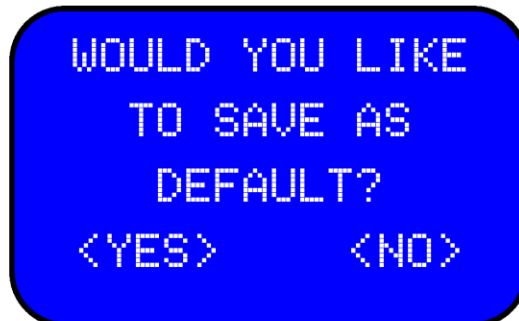

Whenever the Relay 2 Output is enabled a check mark showing that this feature is enabled will be seen on the display.

6.5.5 Voltage Output

Scroll to "VOLTAGE OUTPUT" from "INTERFACE" using the ▲ ▼ keys and press ENTER.

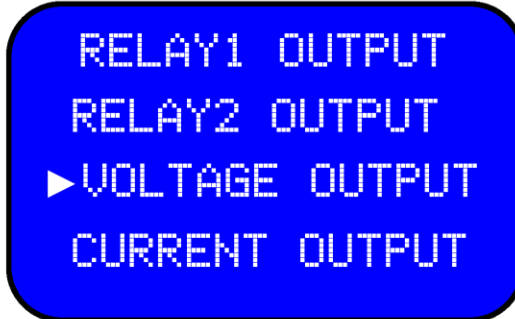

Use the ◀ ▶ keys to either disable or enable the Voltage Output activity .

The configuration of the Voltage Output should be set under the output config menu. Refer to section (6.4.4) for more details.

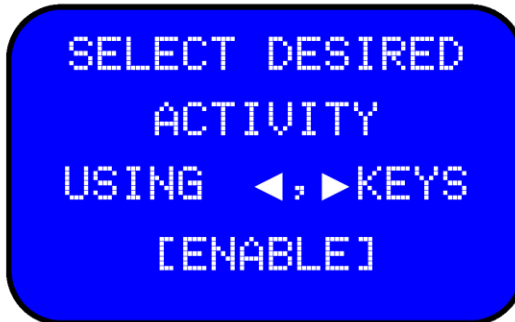

A prompt will be shown to set this value as a default setting.

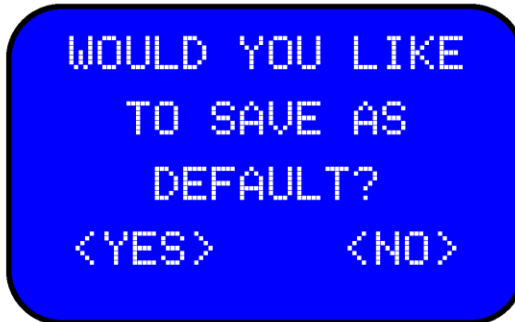

Whenever the Voltage Output is enabled a check mark showing that this feature is enabled will be seen on the display.

6.5.6 Current Output

Scroll to "CURRENT OUTPUT" from "INTERFACE" options using the ▲▼ keys and press ENTER.

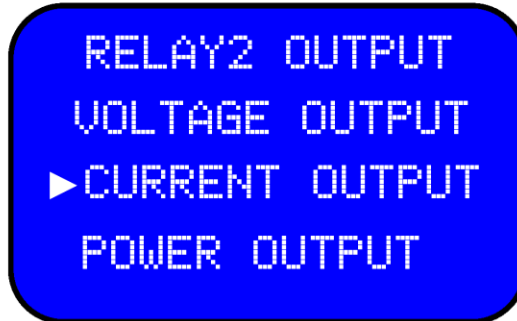

Use the ◀▶ keys on to either disable or enable the Current Output.

The configuration of the Current Output should be set under the output config menu. Refer to section (6.4.5) for more details.

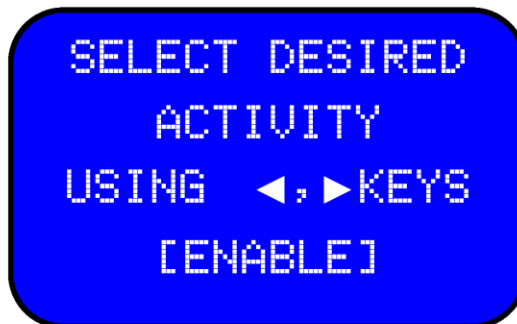

A prompt will be shown to set this value as a default setting.

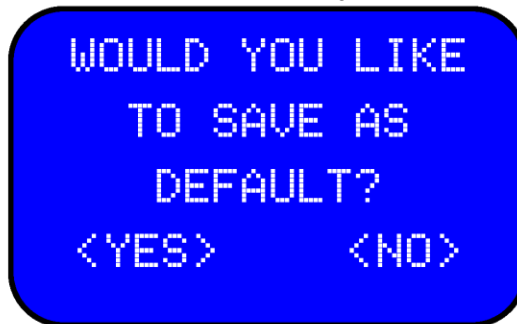

Whenever the Current Output is enabled a check mark showing that this feature is enabled will be seen on the display.

6.5.7 Power Output

Scroll to "POWER OUTPUT" from "INTERFACE" options using the ▲▼ keys and press ENTER.

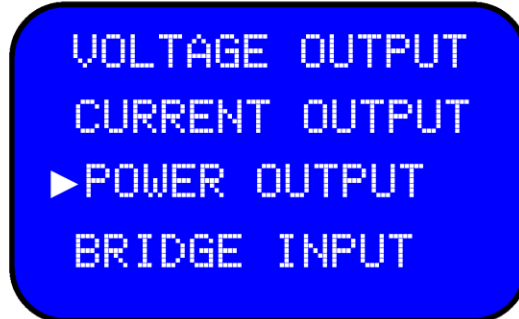

Use the ◀▶ keys to either disable or enable the Power Output.

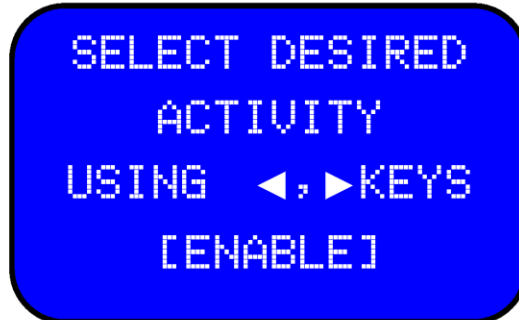

Depending on the type of sensor that has already defined in the current sensor profile, a warning message will be displayed when attempting to enable an input type which is not matched with the sensor configuration.

For example, if the active channel 2 is defined as a bridge input the following warning message will appear on the screen when activating the Power Output:

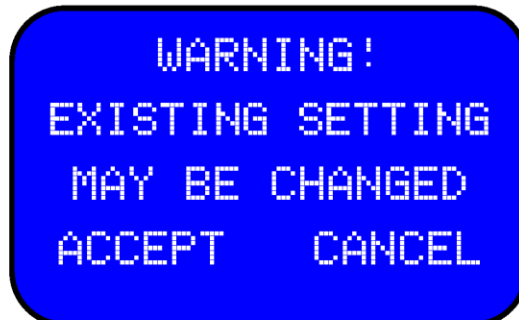

Whenever the Power Output is enabled a check mark showing that this feature is enabled will be seen on the display.

Important notice: Bridge sensors are internally connected to input number 1, current sensors are connected to input number 2 and voltage sensors are connected to input number 3. Enabling a different type of input can result in incorrect measurements.

6.5.8 Bridge Input

Scroll to "BRIDGE INPUT" from "INTERFACE" using the ▲▼ keys and press ENTER.

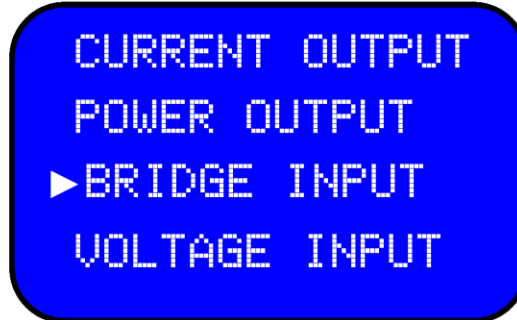

Use the ◀▶ keys to either enable or disable the Bridge Input.

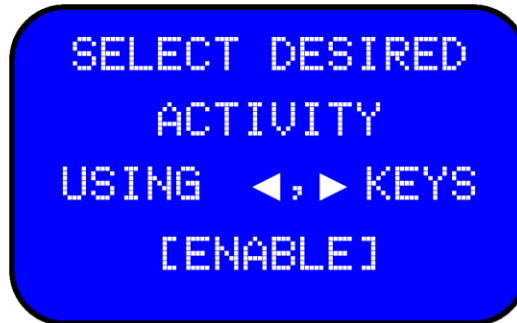

Depending on the type of sensor defined in the current sensor profile, a warning message will be displayed when attempting to enable an input type which is not matched with the sensor configuration.

For example, if the active channel is defined as a bridge input the following warning message will appear on the screen when activating a different input setting:

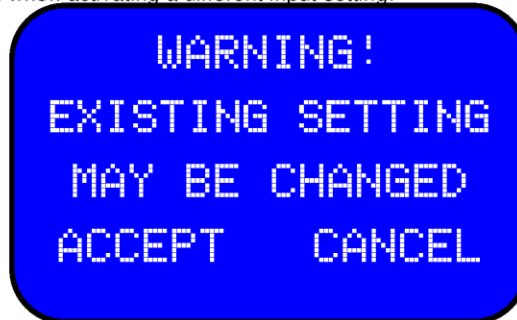

Whenever the Bridge Input is enabled a check mark showing that this feature is enabled will be seen on the display.

Important notice: Bridge sensors are internally connected to input number 1, current sensors are connected to input number 2 and voltage sensors are connected to input number 3. Enabling a different type of input can result in incorrect measurements.

6.5.9 Voltage Input

Scroll to "VOLTAGE INPUT" from "INTERFACE" using the ▲▼ keys and press ENTER.

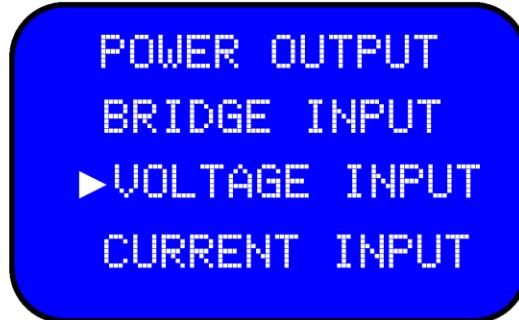

Use the ◀▶ keys to either disable or enable the voltage input.

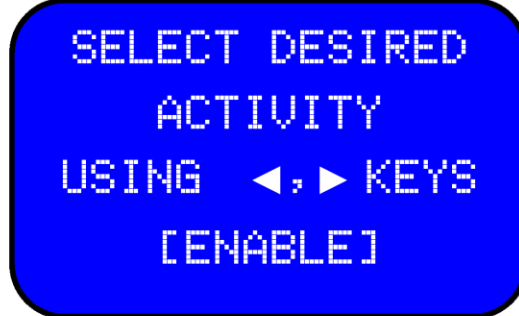

Depending on the type of sensor defined in the current sensor profile, a warning message will be displayed when attempting to enable an input type which is not matched with the sensor configuration.

For example, if the active channel is defined as a bridge input the following warning message will appear on the screen when activating a different input setting:

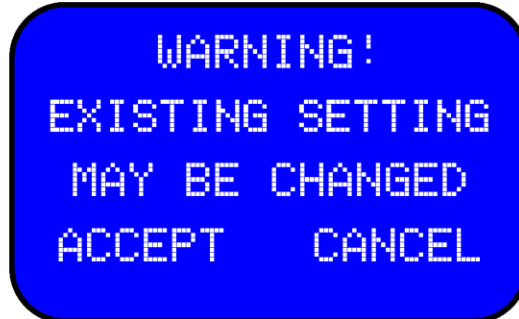

Whenever the Voltage Input is enabled a check mark showing that this feature is enabled will be seen on the display.

Important notice: Bridge sensors are internally connected to input number 1, current sensors are connected to input number 2 and voltage sensors are connected to input number 3. Enabling a different type of input can result in incorrect measurements.

6.5.10 Current Input

Scroll to "CURRENT INPUT" from "INTERFACE" using the ▲▼ keys and press ENTER.

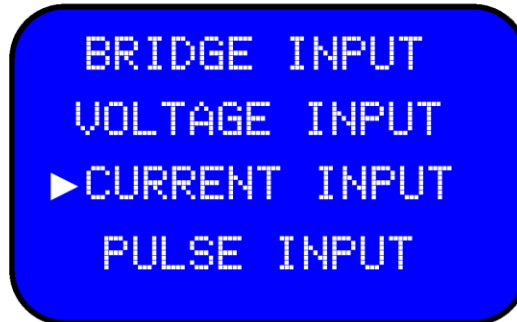

Use the ◀▶ keys to either disable or enable the Current Input.

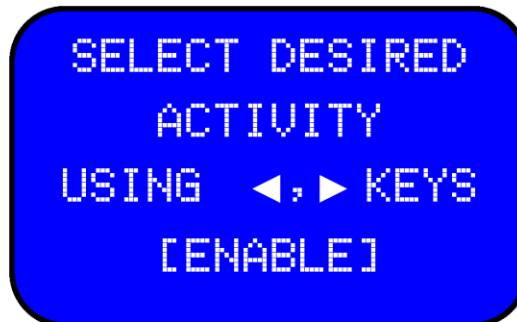

Depending on the type of sensor defined in the current sensor profile, a warning message will be displayed when attempting to enable an input type which is not matched with the sensor configuration.

For example, if the active channel is defined as a bridge input the following warning message will appear on the screen when activating a different input setting:

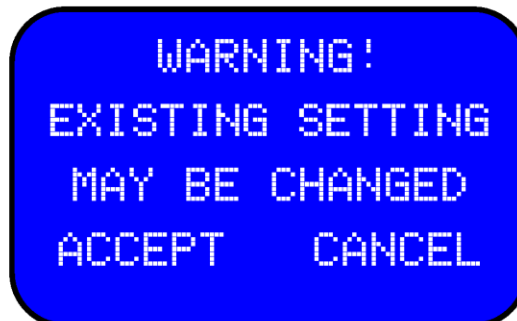

Whenever the Current Input is enabled a check mark showing that this feature is enabled will be seen on the display.

6.5.11 Pulse Input (This feature is available in Elite Version only)

Scroll to "PULSE INPUT" from "INTERFACE" using the ▲▼ keys and press ENTER.

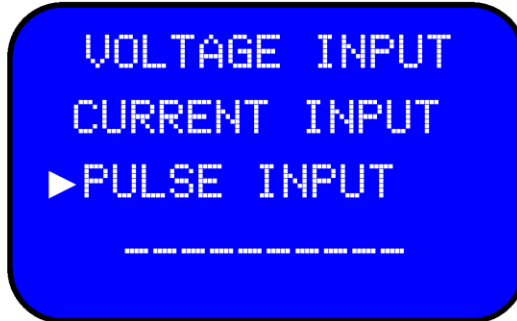

Use the ◀▶ keys to either disable or enable the Pulse Input.

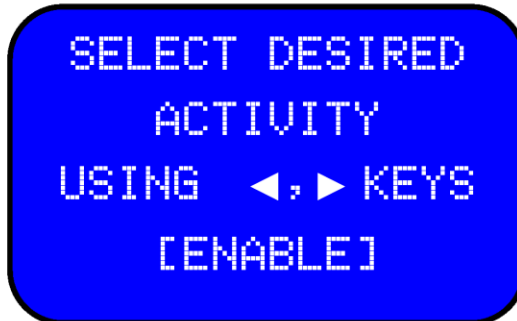

Depending on the type of sensor defined in the current sensor profile, a warning message will be displayed when attempting to enable an input type which is not matched with the sensor configuration.

For example, if the active channel is defined as a bridge input the following warning message will appear on the screen when activating a different input setting:

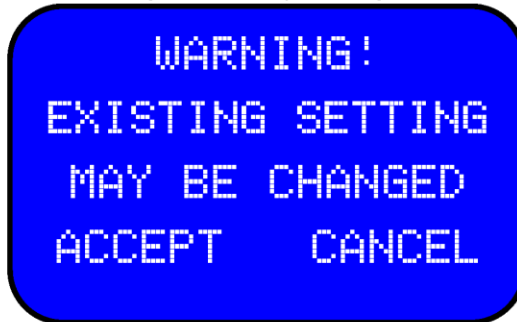

Whenever the Pulse Input is enabled a check mark showing that this feature is enabled will be seen on the display.

6.6 LCD Setting

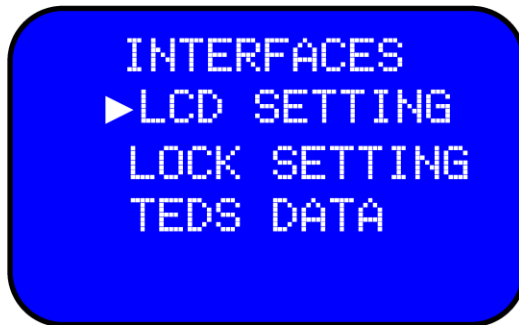
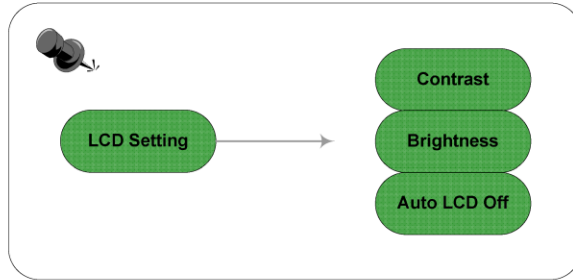

6.6.1 Contrast

Scroll to "CONTRAST" from "LCD SETTING" using the ▲▼ keys and press ENTER.



Use the ◀▶ keys to select the desired LCD contrast level.



A prompt will be shown to set this value as a default setting.

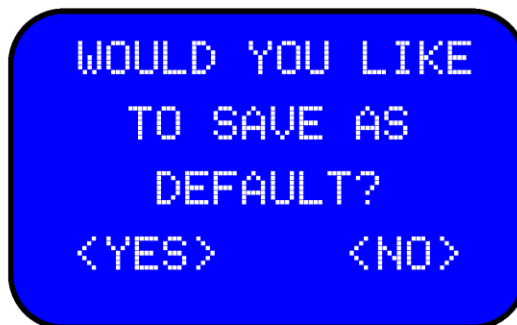

6.6.2 Brightness

Scroll to "BRIGHTNESS" from "LCD SETTING" using the ▲▼ keys and press ENTER.



Use the ◀▶ keys to select the desired LCD brightness level.



The desired Brightness can be saved as default.

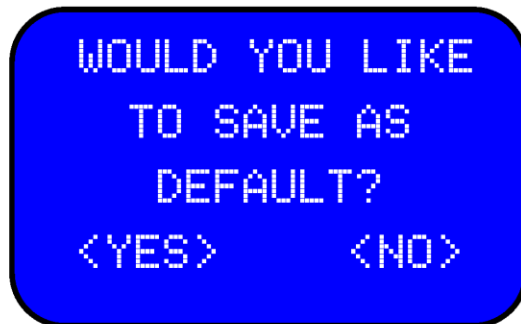

6.6.3 Auto LCD off

Scroll to "AUTO LCD OFF" from the "LCD SETTING" using the ▲ ▼ keys and press ENTER.



Use the ◀ ▶ keys to Enable or Disable the Auto LCD Off feature. The Auto LCD Off timer can be set for 1-15min, after which the LCD will turn off if left unattended, in order to conserve the battery life.



A prompt will be shown to set this value as a default setting.

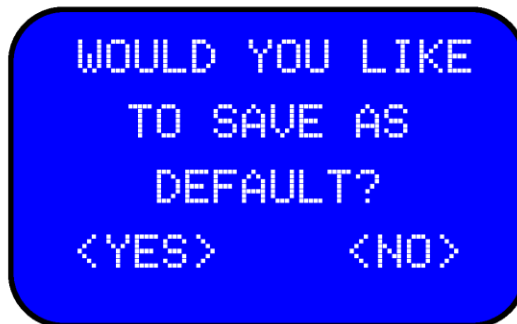

6.7 Lock Settings

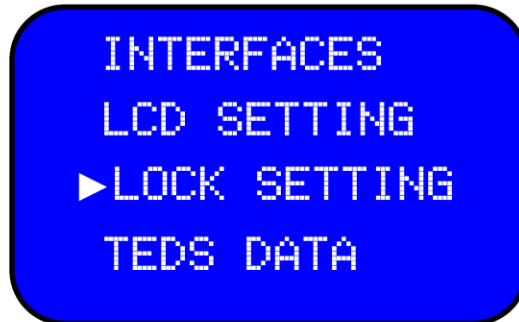
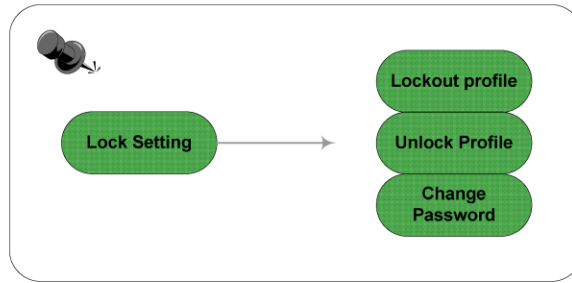

The Lock Setting menu is used to control access to the Sensor Profile settings and data information that have been stored in internal non-volatile memory (7.1.3.x and 7.1.4.x). Additionally, the Lock Setting menu is used to control the following submenus in Sensor Profile menu: New, Edit, Save, Delete.

6.7.1 Lockout Profile

Scroll to “**LOCKOUT PROFILE**” from “**LOCK SETTING**” using the ▲▼ keys and press **ENTER**. Once pressed **ENTER**, this feature will lockout the Edit, New, Save, and Delete of **SENSOR PROFILE** menu. However the Existing Channel(s) and the View Channel(s) options are still accessible.

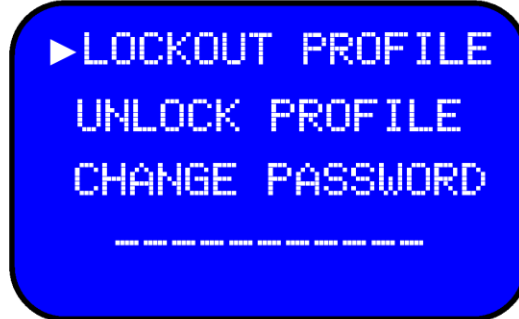

Enter the current password to lockout the sensor profile. If the correct password is entered the following success message will be displayed.

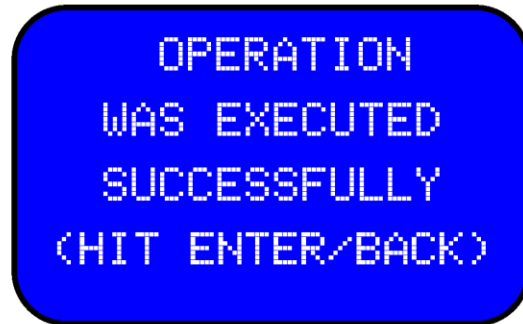

If the password is entered incorrectly, an invalid password message will appear:

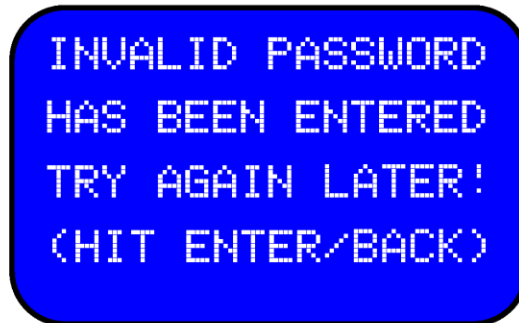

6.7.2 Unlock profile

Scroll to “**UNLOCK PROFILE**” from “**LOCK SETTING**” using the ▲▼ and press **ENTER**. Once pressed the **ENTER**, this feature unlocks the sensor profile menu and full access to sensor profile will be gained.

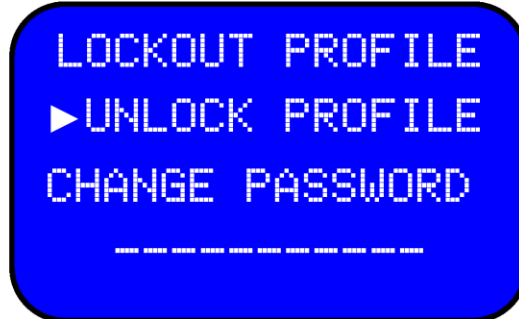

Enter the current password to unlock the sensor profile. If the correct password is entered, the following success message will be displayed.

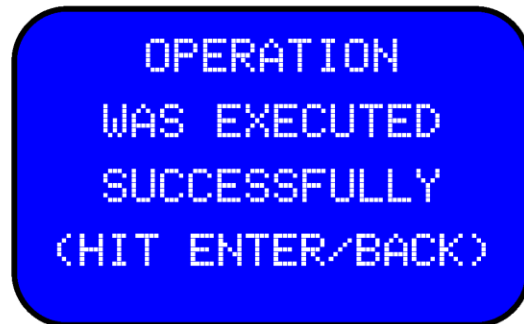

If the password is entered incorrectly, an invalid password message will appear:

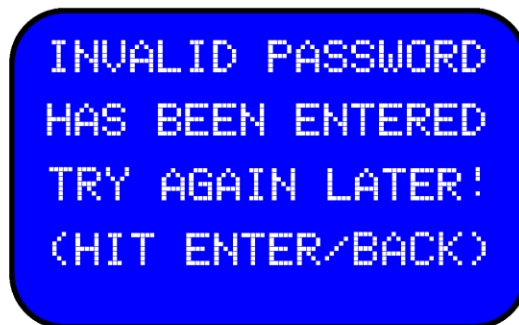

6.7.3 Change Password

Scroll to "**CHANGE PASSWORD**" from "**LOCK SETTING**" using the ▲▼ keys and press **ENTER**.

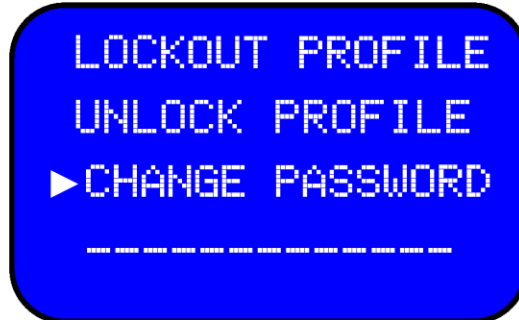

Use the ◀▶ and ▲▼ keys to select the current password.



The current password shall be entered in order to be able to change the password. Once an incorrect password is entered, the following message will appear:

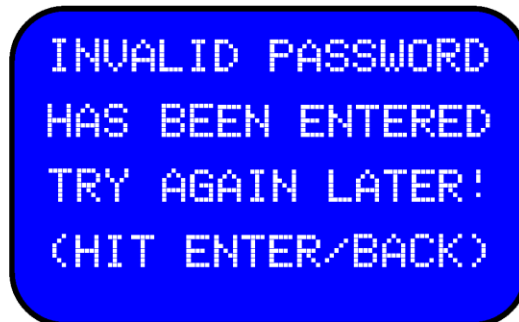

Use the ◀▶ and ▲▼ keys to set the desired password. Any combination of seven digits can be chosen. Press **ENTER** to save the new password.



SELECT DESIRED
PASSWORD
USING ARROW KEYS
[0000000]

The following success message will appear on the screen once the desired password has been entered.

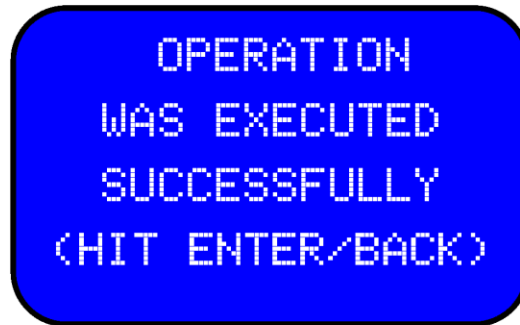

OPERATION
WAS EXECUTED
SUCCESSFULLY
(HIT ENTER/BACK)

NOTE:

The IHH500 has a default password ([0000000]) mentioned in Appendix C. This password can be updated with desired password. Additionally there is an alternative permanent (please see Appendix C). In case the assigned password is forgotten, the alternative password can be used as the current password to lock/unlock /change the setting submenus.

RMS Noise (μV):

Output data Rate (Hz)	Settling Time (ms)	$S \leq 500\text{mV/V}^*$	$S \leq 7.5\text{mV/V}$	$S \leq 3.5\text{mV/V}$
5	818	0.256	0.640	1.152
10	400	0.330	0.896	1.472
25	160	0.544	1.344	2.304
30	133.4	0.615	1.472	2.560
50	80	0.900	2.112	3.584
60	66.7	0.970	2.304	3.968
100	40	1.161	2.816	4.864
200	20	1.567	3.968	6.900
400	10	2.067	5.440	9.600
600	6.66	2.400	6.656	11.648
800	5	2.734	7.936	13.824
960	4.17	3.000	8.960	15.488
1200	3.33	3.334	9.856	17.152
1600	2.5	3.8889	11.264	19.8826
2400	1.67	5.000	14.080	25.344
4800	0.83	14.300	24.320	337.760

* : The same specification will be applied to current and voltage input channel.

Effective Resolution (peak to Peak Resolution):

Output data Rate (Hz)	Settling Time (ms)	$S \leq 500\text{mV/V}^{**}$	$S \leq 7.5\text{mV/V}$	$S \leq 3.5\text{mV/V}$
5	800	23 (21.5)	23 (20)	22 (19.5)
10	400	23 (21)	22.5 (19.5)	21.5 (19)
25	160	22 (19)	22 (19)	21 (18)
30	133.3	23 (20.5)	22 (19)	21 (18)
50	80	22.5 (19.5)	21 (18.5)	20.5 (17.5)
60	66.7	22.5 (19.5)	21 (18.5)	20.5 (17.5)
100	40	23 (19.5)	21 (19)	21 (17.5)
200	20	21.5 (19)	20 (17.5)	19 (17)
400	10	21 (18.5)	20 (17)	19 (16)
600	6.7	21 (18)	19.5 (17)	19 (16)
800	5	21 (18)	19.5 (17)	18.5 (16)
960	4.17	20.5 (19)	20 (17.5)	18.5 (15.5)
1200	3.33	20.5 (18)	19 (16)	18 (15.5)
1600	2.5	20 (17.5)	18.5 (15.5)	18 (15)
2400	1.67	20 (17)	18.5 (15.5)	17.5 (15)
4800	0.83	18.5 (15.5)	17.5 (15)	17 (14.5)

** : The same specification will be applied to current and voltage input channel.

Last Updated: 01/29/2012

6.8.1 TEDS Device

Scroll to "TEDS DEVICE" from "TEDS DATA" using the ▲▼ keys and press ENTER.

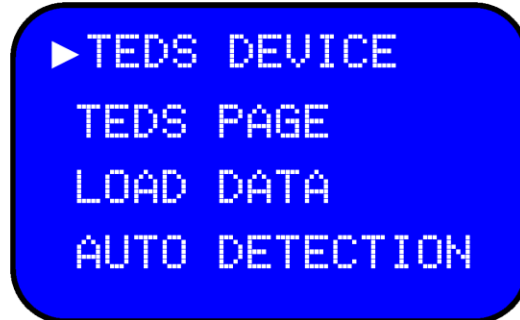

If a TEDS device is connected, the TEDS information will be displayed as shown below:

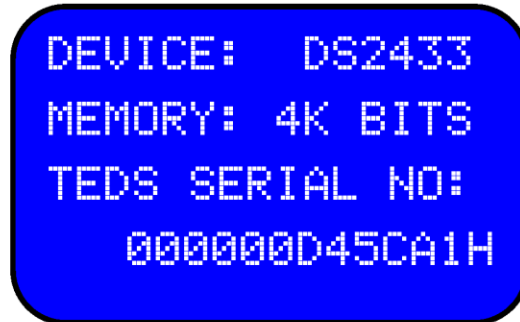

If the TEDS DEVICE is selected without a connected TEDS device, an error message will be displayed.



6.8.2 TEDS Page

Scroll "TEDS PAGE" from "TEDS DATA" using THE ▲ ▼ keys and press ENTER. A total of sixteen pages (0 – 15) can be selected

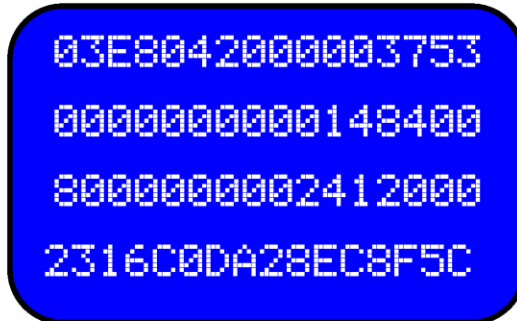

If **TEDS PAGE** is selected, without a connected TEDS device, an error message will be displayed.

Each TEDS page is 32 bytes and is mapped as bellow:

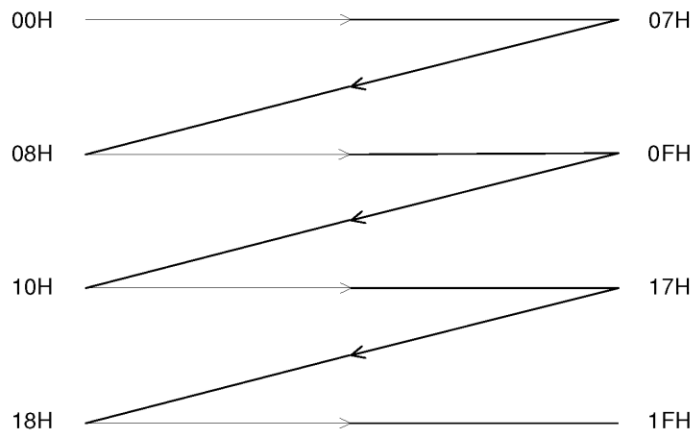

6.8.3 Load Data

Scroll to "LOAD DATA" from "TEDS DATA" using the ▲▼ keys and press ENTER.



The load data option loads the new profile, based on the TEDS data, and performs an auto calibration.



If **Load Data** is selected, without a connected TEDS device, an error message will be displayed.

6.8.4 Auto Detection

Scroll to “**AUTO DETECTION**” from “**TEDS DATA**” using the ▲ ▼ keys and press **ENTER**.

If “**AUTO DETECTION**” is enabled, the IHH500 will search for a TEDS device during power up. If TEDS information exists, its information will be loaded; otherwise the IHH500 will load the active channel.

If “**AUTO DETECTION**” is disabled, the IHH500 will load the active channel during power up.



Use the ◀ ▶ keys to Enable or Disable the TEDS Auto Detection feature

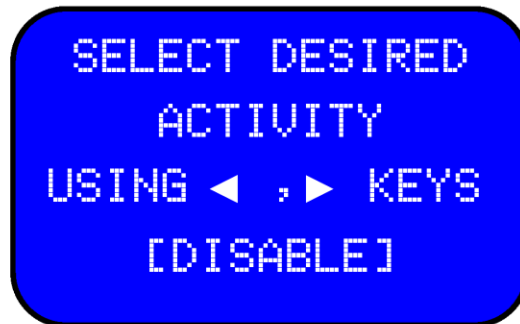

The following message will be displayed confirming the operation was executed successfully.

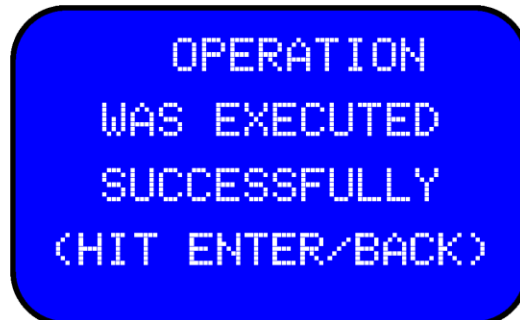

6.9 Diagnostic



Select "DIAGNOSTIC" from the main menu options.

6.9.1 Internal or External

Scroll to "DIAGNOSTIC" using the ▲▼ keys and press **ENTER**.

Use the ◀▶ keys to select either **INTERNAL** or **EXTERNAL** diagnostic.

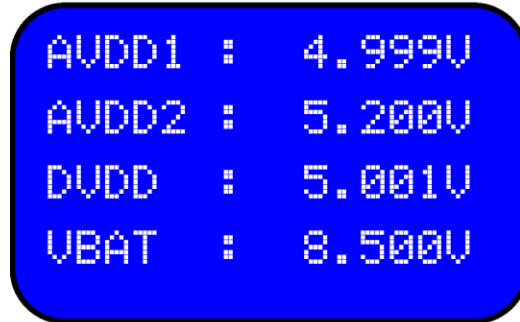
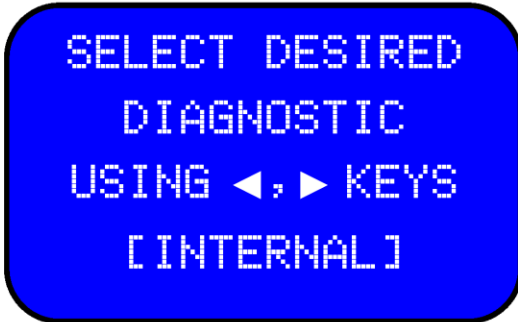

The internal diagnostic shows the analog VDD1, analog VDD2, digital VDD and VBAT values.

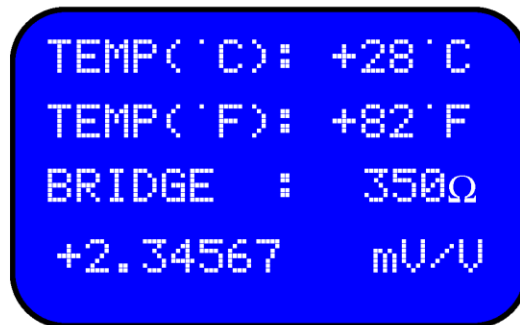
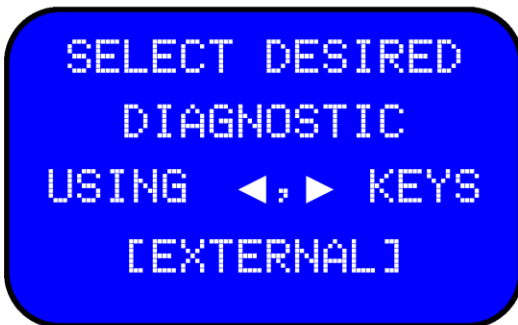

The external diagnostic shows the sensor sensitivity, Temp, and bridge resistance.

NOTE:

The external diagnostic page can only show the information of a Strain gage with the sensitivity of less than 4mV/V. If the sensor is amplified voltage output or current output or has a sensitivity more than 4 mV/V, when trying to display External Diagnostic, an error message will appear stating that this function is not available.

7 Appendix A (List of Probable Errors)

Error No.	Error Description on the LCD
Error #1	TEDS DEVICE WAS NOT DETECTED
Error #2	UNKNOWN DEVICE WAS DETECTED
Error #3	UNKNOWN TEMPLATE WAS DETECTED
Error #4	UNKNOWN UNIT WAS DETECTED
Error #5	ELECTRICAL VALUE IS INVALID
Error #6	TEDS DATA IS INVALID
Error #7	BRIDGE TYPE IS INVALID

Error #1 TEDS DEVICE WAS NOT DETECTED

If any non TEDS sensor is connected or if TEDS is not connected properly the mentioned error will occur.

Error #2 UNKNOWN DEVICE WAS DETECTED

The IHH500 supports chip number DS2430, DS2431, DS2432 and DS2433. Any other TEDS device with a different data sheet numbers will not be able to interact with the IHH500.

Error #3 UNKNOWN TEMPLATE WAS DETECTED

The IHH500 supports template numbers 30 and 33; any other TEDS device with different template numbers will not be able to interact information with the IHH500.

Error #4 UNKNOWN UNIT WAS DETECTED

If the sensor's TEDS has been defined with units other than IEEE standard units, the mentioned error will occur.

Error #5 ELECTRICAL VALUE IS INVALID

This error occurs when the electrical values are more than defined values.

Error #6 TEDS DATA IS INVALID

The defined TEDS information is invalid.

Error #7 BRIDGE TYPE IS INVALID

The IHH 500 supports full bridge only configurations, therefore any other bridge type transducers like quarter or half plugged to this device will not recognized and the mentioned error to occur.

8 Appendix B (List of Messages)

Message No.	Message Description on the LCD	pages
Welcome Message	FUTEK ADVANCED SENSOR TECH INC. IHH500-ELITE MADE IN USA	15
Delete Message	WARNING! SELECTED PROFILE MAY BE LOST! ACCEPT CANCEL	61
Delete Confirmation	ARE YOU SURE WANT TO DELETE ACTIVE CHANNEL? YES NO	61
Interface Warning	WARNING! EXISTING SETTING MAY BE CHANGED ACCEPT CANCEL	92,93,94,95,96
Unsaved Data Warning	WARNING! EXIT WITHOUT SAVING PROFILE? YES NO	29
Success Message	OPERATION WAS EXECUTED SUCCESSFULLY HIT ENTER / BACK	30,31,33,34,35,36,37,38,39, 41,42,43 ,44,47,49,52,54,60,63, 103,104,106,108,110
Confirmation Message	WOULD YOU LIKE TO SAVE AS DEFAULT? YES NO	65,66,67,70,71,73,75,79,80,81,82,83,84 87,88,89,90,91,92,99,100,101
Edit/ delete Warning	THERE IS NOT ANY CHANNEL AVAILABLE FOR THIS INTENTION	54,60
(+)No Load Calibration	APPLY ZERO LOAD (+) CALIBRATION THEN PRESS ENTER	40
(+)Full Load Calibration	APPLY FULL SCALE (+) CALIBRATION THEN PRESS ENTER	41
(-)Full Load Calibration	APPLY FULL SCALE (-) CALIBRATION THEN PRESS ENTER	41
(-)No Load Calibration	APPLY ZERO LOAD (-) CALIBRATION	41

	THEN PRESS ENTER	
Unavailable Feature	SELECTED FEATURE IS NOT AVAILABLE AT THIS TIME HIT ENTER / BACK	28,54,58,62
Battery full	BATTERY FULL! YOU CAN UNPLUG BATTERY CHARGER FROM THE DEVICE	18
Battery low	BATTERY LOW! CONNECT THE BATTERY CHARGER TO THE DEVICE	18
Incorrect password Warning	INVALID PASSWORD HAS BEEN ENTERED TRY AGAIN LATER! (HIT ENTER/ BACK)	102,103,104
Data Logging Confirmation	DATA LOGGING PROGRESS COMPLETED SUCCESSFULLY	75,76

9 Appendix C (Device Specifications)

Main Control Processor Unit (MCPU)

Part #:	MSC1214 (Elite Version)	
Internal ADC Resolution:	24 bits	
Sampling Rate:	60SPS	
Application:	Diagnostic mode	
DAC Resolution: *	16bits	
DAC Accuracy: *	0.02% of FSR (Factory Calibrated)	
DAC Non linearity:*	0.1% of FSR (Factory Calibrated)	
Application:*	Voltage output/ Current output	

Analog to Digital Converter (ADC)

Part #:	AD7190	
Recommended Load:	30 to 30000Ω	
Bridge Excitation:	5.000V ± 1mV	
Input Range:	±2.5V (0-500mV/V)	Channel1 for bridge
Input Range:	±12V	Channel2 for Voltage/Current input
Sampling rate:	up to 4800 SPS	
Non linearity:	± 5 PPM for FSR	
Offset Drift vs temperature:	± 5 PPM/°C	
Span Drift vs temperature:	± 5 PPM/°C	
Application:	Signal measurement	

Voltage Reference

Part # :	MAX6126AASA25+
Accuracy:	± 0.02%
Nominal Voltage:	2.5V
Temperature Shift:	± 3 PPM/°C
Application:	Reference Voltage / Excitation voltage

Power Requirement

Internal battery:	Rechargeable, lithium polymer battery
Battery size:	7.4 V/ 3000 mAh
Run Time:	up to 30 hours with 350Ω Bridge
Battery Charger:	Wall plug AC powered-unit
Battery Charger Output:	12 V/ 1A
Battery Indicator:	0-100 %, 0-8.5 V
Battery Warning:	Less than 20%
Run Time:	Up to 30 hours (350 Ohm Bridge connected)

Solid State Relays *

Part #:	G3VM-2F
Application:	Alarm relay 1, 2
Maximum Output Voltage:	250 V (AC or CD)
Maximum Output Current:	120mA
Note:	Internally limited and protected to 110 V/100 mA

***Available in Elite Version Only**

Liquid Crystal Display (LCD)

Part #: CFAH1604B-TMI-ET
 Brand: Crystallfontz America, Inc.
 Number of Characters
 (Width): 16 Characters
 No. of Lines (Lines): 4 Lines
 Backlight Type & Color: T-LED, white
 Fluid Type, Image (Positive or Negative), & LCD glass Color: M-STN, Negative, blue
 Polarizer Film Type, Wide (WT) Temperature Range, & Viewing Angle (O'clock): I-Transmissive, WT, 6:00
 Character Set (CGROM): English and European fonts
 Controller: T-Sitronix ST7066U

Mounting detail

2 pin male connector:	99 5101 00 02	IP66
2 pin Female connector:	09 0104 99 02	IP66
4 pin male connector:	99 5109 00 04	IP66
4 pin Female connector:	09 0112 99 04	IP66
8 pin male connector:	99 5171 00 08	IP66
8 pin Female connector:	09 0174 99 08	IP66
12 pin male connector:	99 5129 00 12	IP66
12 pin Female connector:	09 0132 90 12	IP66

Power Output *

Part#: DCP020515DU, LM2671
 Nominal Output1: 24V / 50mA
 Nominal Output2: 5V / 50mA
 Application: Excitation for amplified sensors

Response Times

Conversion capture rate: every sample
 Peak capture rate: every sample
 Valley capture rate: every sample
 Conversion display update rate: 5 times per second
 Peak display update rate: 5 times per second
 Valley display update rate: 5 times per second

Bandwidth

The digital output bandwidth has been specified as **SPS/4**.
 The analog output bandwidth has been specified as **SPS/4** for sampling rates **less than 1200 SPS** and has been specified as **SPS/5** for sampling rates **more than 1200 SPS** if:
 a. ASCII stream output is deactivated,
 b. IHH500 is not connected to computer,
 c. All relays are disabled
 d. Display is in menu mode (Peak, Valley, Tracking and data display are main display mode).

Default Password: 0000000
Alternative Password: Device's Serial Number

Instrument Weight: 1.85 lbs (840 g) without mounting bracket
 Dimensions: 4" (W) x 6" (L) x 1.65" (D)

10 Appendix D TEDS IEEE 1451.4 Introduction

10.1 What is TEDS?

Plug and play sensor hardware and software makes configuring a smart TEDS sensor as easy as plugging a mouse into a PC. Efficiency and productivity has greatly improved due to the elimination of manual sensor configuration.

10.2 Basic Concept

TEDS is at the heart of the new universally accepted IEEE1451.4 standard for delivering plug and play capabilities to analog measurements and test instruments. In essence, information in a Transducer Electronic Data Sheet (TEDS), provides instruments with critical sensor calibration information allowing for accurate and precise measurements every time.

- TEDS works in a similar way in which USB computer peripherals immediately work when a USB device is connected.
- TEDS enabled equipment may be swapped out without a recalibration, saving time and money.
- TEDS holds information such as sensor manufacturer, model and serial numbers, and more importantly, all of the calibration settings determined by the manufacturer.

10.3 How it works

Plug and play is a data acquisition technology that can simplify the configuration of automated measuring systems by making a sensor's unique identification data available electronically. As implemented according to IEEE P1451.4, data in the form of a transducer electronic data sheet (TEDS) is burned on an electrically erasable programmable read only memory (EEPROM) chip located on the sensor, so when a properly adapted signal conditioner interrogates the sensor, it can interpret the self identification data. This technology provides a great benefit by eliminating the need for a traditional paper calibration sheets. In addition, it can simplify labeling and cabling problems, as well as inventory control; by letting you burn the location data onto the chip when installing a sensor. Finally, because all sensors that are produced according to the standard will carry the same basic identically formatted self-identification information, you will be able to use the sensors and applicable signal conditioners interchangeably across manufacturers.

Appendix E (System Performance)

Specifications:

Parameter	ADC	Unit
Output Data Rate	5 to 4800	Hz nom
No Missing Codes	24	Bits min
Resolution	See the following RMS Noise and Resolution Table	
RMS Noise and Output Data Rates	See the following RMS Noise and Resolution Table	
Integral Nonlinearity	±5 (Current or Voltage Input) ±15 (Bridge Input)	ppm of FSR max ppm of FSR max
Offset Error	±0.58	µV/ typ
Offset Error Drift vs. Temperature	±0.78	nV/°C typ
Offset Error drift vs. Time	25	nV/1000 hours typ
Gain Error	±0.005 (Current or Voltage Input) ±0.0075 (Bridge input)	% max %typ
Gain Drift vs. Temperature	±1	ppm/°C typ
Gain Drift vs. Time	10 (Current or Voltage Input)	ppm/1000 hours typ
Power Supply Rejection	95 (Current or Voltage Input) 100 (Bridge input)	dB typ dB min
Common Mode rejection @ DC	100 (Current or Voltage Input) 110 (Bridge input)	dB min dB min
@50Hz, 60Hz	120	dB min
@50Hz, 60Hz	120	dB min
Normal Mode Rejection	120 (10 Hz output data rate) 82 (50 Hz output data rate)	dB min dB min
Normal Mode Rejection Common Mode Rejection Reference Detect Levels	Same as for analog inputs 95 0.3 0.6	dB typ V min V max