



5700XP

(Electric)

(1000000-)

Walk-Behind Scrubber Operator Manual

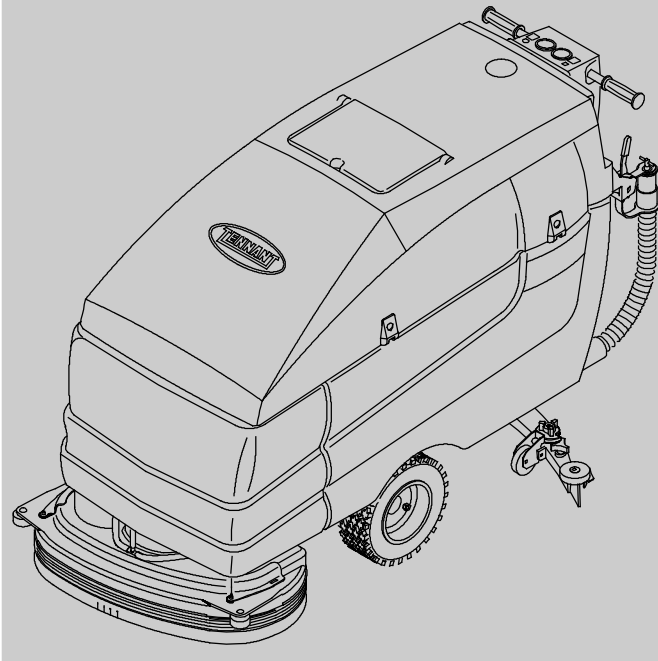

The Safe Scrubbing Alternative®



TennantTrue® Parts
IRIS® a Tennant Technology

North America / International



For the latest Parts manuals and other language Operator manuals, visit:

www.tennantco.com/manuals

331533
Rev. 04 (10-2015)



This manual is furnished with each new model. It provides necessary operation and maintenance instructions.



Read this manual completely and understand the machine before operating or servicing it.

This machine will provide excellent service. However, the best results will be obtained at minimum costs if:

- The machine is operated with reasonable care.
- The machine is maintained regularly - per the machine maintenance instructions provided.
- The machine is maintained with manufacturer supplied or equivalent parts.

To view, print or download manuals online visit www.tennantco.com/manuals



PROTECT THE ENVIRONMENT

Please dispose of packaging materials, used components such as batteries and fluids in an environmentally safe way according to local waste disposal regulations. Always remember to recycle.

MACHINE DATA

Please fill out at time of installation for future reference.

Model No. - _____

Serial No. - _____

Installation Date - _____



INTENDED USE

The 5700 walk behind scrubber is designed to scrub hard surfaces (concrete, asphalt, stone, synthetic, etc) in an indoor environment. Typical applications include hotels, schools, hospitals, factories, shops, offices, and rental businesses. Do not use this machine on carpeted surfaces. Use only recommended pads and commercially available floor cleaners intended for machine application. Do not use this machine other than described in this Operator Manual.

Tennant Company

PO Box 1452

Minneapolis, MN 55440

Phone: (800) 553- 8033 or (763) 513- 2850

www.tennantco.com

FaST- PAK and Insta-Fit are US registered and unregistered trademark of Tennant Company.

Specifications and parts are subject to change without notice.

Copyright © 2006- 2015 TENNANT, Printed in U.S.A.

CONTENTS

	Page		Page
SAFETY PRECAUTIONS	3	ELECTRIC MOTORS	49
OPERATION	5	SCRUB HEAD	50
OPERATOR RESPONSIBILITY	5	DISK BRUSH SCRUB HEAD SKIRT ..	50
MACHINE COMPONENTS	6	ADJUSTING THE SCRUB	
CONTROL PANEL SYMBOLS	7	HEAD SKIRT	50
CONTROLS AND INSTRUMENTS	8	REPLACING THE SCRUB	
STEERING HANDLES	9	HEAD SKIRT	51
SOLUTION FLOW LEVER	10	CYLINDRICAL BRUSH SCRUB HEAD	
POWER WAND SWITCH (OPTION) ..	10	SKIRTS	52
RECOVERY TANK FULL LIGHT	11	ADJUSTING THE SCRUB HEAD	
ES SWITCH (OPTION)	11	SKIRTS	52
BATTERY DISCHARGE INDICATOR ..	11	REPLACING THE SCRUB HEAD	
BRUSH PRESSURE GAUGE	12	SKIRTS	52
SCRUB BRUSHES DOWN LIGHT	12	REMOVING OR REPLACING THE	
SCRUB BRUSHES SWITCH	13	SCRUB HEAD	53
HOURMETER	13	LEVELING THE SCRUB HEAD	55
MACHINE ON LIGHT	13	SCRUB BRUSHES	56
ON-OFF KEY SWITCH	14	DISK BRUSHES	56
SQUEEGEE LEVER	14	REPLACING THE DISK BRUSHES ..	56
SOLUTION TANK LOCKING TAB	14	CYLINDRICAL BRUSHES	59
SPEED REDUCTION KNOB (OPTION) ..	14	REPLACING THE CYLINDRICAL	
POWER KILL SWITCH (OPTION)	15	BRUSHES	59
CIRCUIT BREAKERS	15	CHECKING AND ADJUSTING	
SOLUTION TANK HOSE	16	CYLINDRICAL BRUSH PATTERN ..	60
RECOVERY TANK DRAIN HOSE	16	SOLUTION SYSTEM	62
SUPPORT ARM	16	RECOVERY TANK	62
STOP ARM	16	SOLUTION TANK	63
SQUEEGEE DOWN PRESSURE		SQUEEGEE	64
CAMS	17	REMOVING THE SQUEEGEE	
SQUEEGEE LEVELING KNOB	17	ASSEMBLY	64
PARKING BRAKE (OPTION)	17	INSTALLING THE SQUEEGEE	
HOW THE MACHINE WORKS	18	ASSEMBLY	65
BRUSH AND PAD INFORMATION	19	LEVELING THE SQUEEGEE	65
PRE-OPERATION CHECKLIST	20	ADJUSTING SQUEEGEE BLADE	
STARTING THE MACHINE	21	DEFLECTION	66
FILLING THE TANKS	21	ADJUSTING THE SQUEEGEE GUIDE	
WHILE OPERATING THE MACHINE	24	ROLLERS	67
SCRUBBING	24	SQUEEGEE BLADES	67
DOUBLE SCRUBBING	26	REPLACING OR ROTATING THE	
STOP SCRUBBING	27	REAR SQUEEGEE BLADE	67
DRAINING AND CLEANING THE TANKS ..	28	REPLACING OR ROTATING THE	
STOP THE MACHINE	33	FRONT SQUEEGEE BLADE	68
OPERATION ON INCLINES	33	BELTS AND CHAINS	70
POST-OPERATION CHECKLIST	34	BRUSH DRIVE BELT	70
MACHINE TROUBLESHOOTING	35	STATIC DRAG CHAIN	70
OPTIONS	36	TIRES	71
VACUUM WAND	36	PUSHING AND TRANSPORTING THE	
POWER WAND	40	MACHINE	71
MAINTENANCE	45	PUSHING THE MACHINE	71
MAINTENANCE CHART	45	TRANSPORTING THE MACHINE	72
LUBRICATION	46	MACHINE JACKING	74
REAR CASTERS	46	STORAGE INFORMATION	74
TRANSAXLE	46	FREEZE PROTECTION	74
BATTERIES	46		
CHARGING THE BATTERIES	48		

CONTENTS

	Page
SPECIFICATIONS	75
GENERAL MACHINE	
DIMENSIONS/CAPACITIES	75
GENERAL MACHINE PERFORMANCE	76
POWER TYPE	76
TIRES	76
MACHINE DIMENSIONS	77

SAFETY PRECAUTIONS

The following symbols are used throughout this manual as indicated in their description:



WARNING: To warn of hazards or unsafe practices that could result in severe personal injury or death.

FOR SAFETY: To identify actions that must be followed for safe operation of equipment.

This machine is designed solely for scrubbing dirt and dust in an indoor environment. Tennant does not recommend using this machine in any other environment.

The following information signals potentially dangerous conditions to the operator or equipment. Read this manual carefully. Know when these conditions can exist. Locate all safety devices on the machine. Then, take necessary steps to train machine operating personnel. Report machine damage or faulty operation immediately. Do not use the machine if it is not in proper operating condition.



WARNING: Batteries emit hydrogen gas. Explosion or fire can result. Keep sparks and open flame away. Keep covers open when charging.



WARNING: Flammable materials can cause an explosion or fire. Do not use flammable materials in tank(s).



WARNING: Flammable materials or reactive metals can cause an explosion or fire. Do not pickup.

This machine may be equipped with technology that automatically communicates over the cellular network. If the machine will be operated where cell phone use is restricted because of concerns related to equipment interference, please contact a Tennant representative for information on how to disable the cellular communication functionality.

WARNING: This machine contains chemicals known to the state of California to cause cancer, birth defects, or other reproductive harm.

FOR SAFETY:

1. Do not operate machine:
 - Unless trained and authorized.

- Unless operation manual is read and understood.
- In flammable or explosive areas unless designed for use in those areas.

2. Before starting machine:

- Make sure all safety devices are in place and operate properly.
- Check brakes and steering for proper operation (if so equipped).

3. When using machine:

- Go slow on inclines and slippery surfaces.
- Use care when backing machine.
- Follow mixing and handling instructions on chemical containers.

4. Before leaving or servicing machine:

- Stop on level surface.
- Set parking brake (if equipped).
- Turn off machine and remove key.

5. When servicing machine:

- Avoid moving parts. Do not wear loose jackets, shirts, or sleeves when working on machine.
- Block machine tires before jacking machine up.
- Jack machine up at designated locations only. Block machine up with jack stands.
- Use hoist or jack that will support the weight of the machine.
- Wear eye and ear protection when using pressurized air or water.
- Disconnect battery connections before working on machine.
- Wear protective gloves and eye protection when handling vinegar.
- Avoid contact with battery acid.
- Use Tennant supplied or equivalent replacement parts.

6. When loading/unloading machine onto/off truck or trailer:

- Turn off machine.
- Use truck or trailer that will support the weight of the machine.
- Use winch. Do not push the machine onto/off the truck or trailer unless the load height is 380 mm (15 in) or less from the ground.
- Set parking brake after machine is loaded (option).
- Block machine tires.
- Tie machine down to truck or trailer.

SAFETY PRECAUTIONS

The safety labels appear on the machine in the locations indicated. If these or any label becomes damaged or illegible, install a new label in its place.

FLAMMABLE MATERIALS LABEL - LOCATED ON THE UNDERSIDE OF THE SOLUTION TANK COVER.



FOR SAFETY LABEL - LOCATED ON THE OPERATOR CONSOLE.

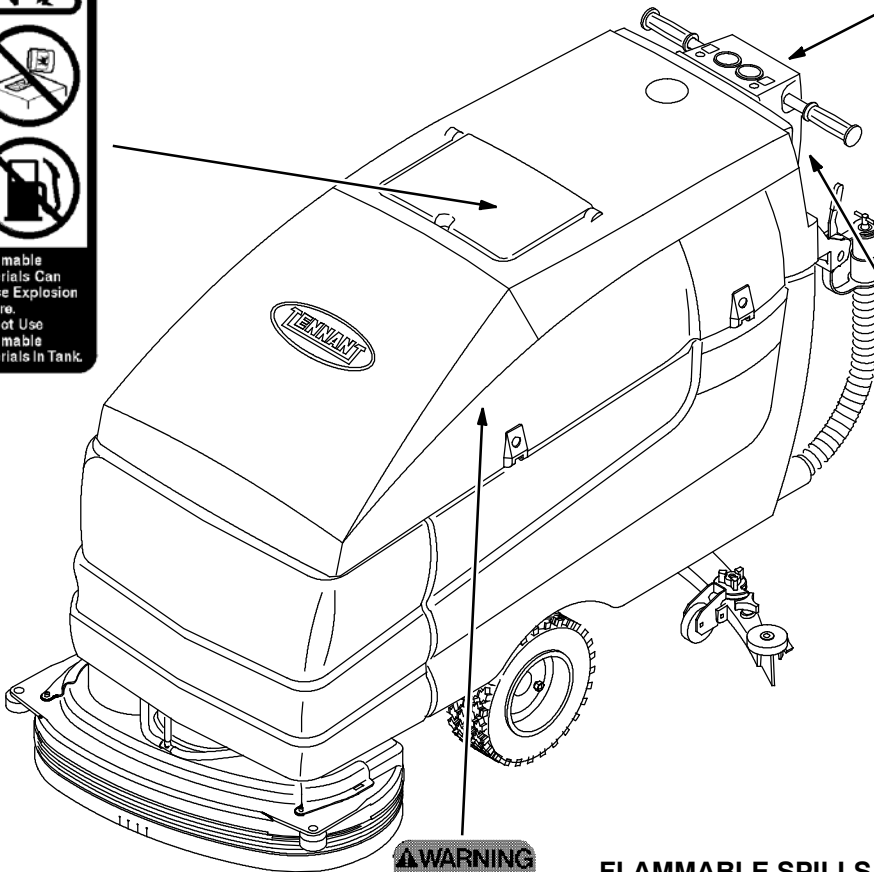
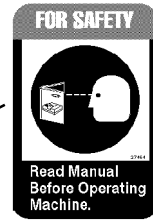

10066



FLAMMABLE SPILLS LABEL - LOCATED ON THE OPERATOR CONSOLE.



BATTERY CHARGING LABEL - LOCATED ON THE UNDERSIDE OF THE SOLUTION TANK.

OPERATION

OPERATOR RESPONSIBILITY

- The operator's responsibility is to take care of the daily maintenance and checkups of the machine to keep it in good working condition. The operator must inform the service mechanic or supervisor when the maintenance intervals are required as stated in the MAINTENANCE section of this manual.
- Read this manual carefully before operating this machine.

FOR SAFETY: Do not operate machine, unless operation manual is read and understood.

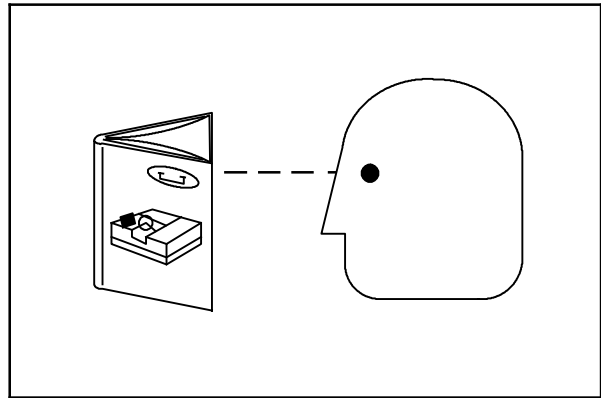

07324

- Check the machine for shipping damage. Check to make sure the machine is complete per shipping instructions.
- Keep your machine regularly maintained by following the maintenance information in this manual. We recommend taking advantage of a regularly scheduled service contract from your Tennant representative.
- Order parts and supplies directly from your authorized Tennant representative. Use the parts manual provided when ordering parts.
- After operation, follow the recommended daily and hourly procedures stated in the *MAINTENANCE CHART*.

OPERATION

MACHINE COMPONENTS

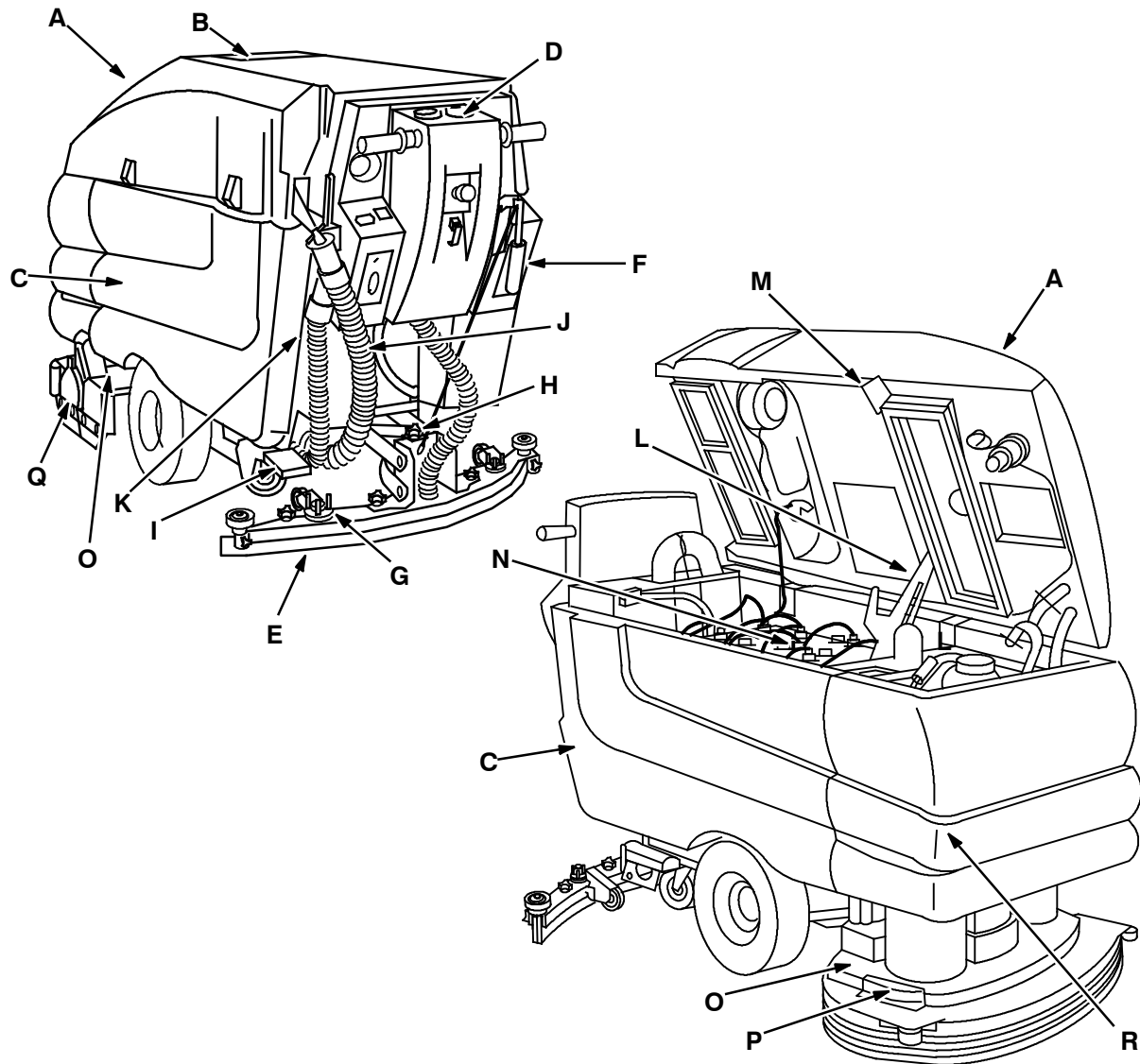

10344
10343

- A. Solution tank
- B. Solution tank fill opening
- C. Recovery tank
- D. Console panel
- E. Squeegee
- F. Squeegee lever
- G. Squeegee down pressure cams
- H. Squeegee leveling knob
- I. Parking brake (option)
- J. Recovery tank drain hose
- K. Solution tank hose
- L. Support arm
- M. Stop arm
- N. Batteries
- O. Scrub head
- P. Scrub brush access cover
- Q. Scrub brush idler door
- R. FaST solution system (option)
ec-H₂O System Module (option)

CONTROL PANEL SYMBOLS

These symbols identify controls and displays on the machine:



Solution flow



Key switch



Battery charge



Variable flow or rate



Power wand or vacuum wand



Circuit breaker #1



Travel speed



Circuit breaker #2



Squeegee



Circuit breaker #3



Brush pressure



Circuit breaker #4



ES (Extended scrub)



Circuit breaker #5



Recovery tank full



Circuit breaker #6



Scrubbing

OPERATION

CONTROLS AND INSTRUMENTS

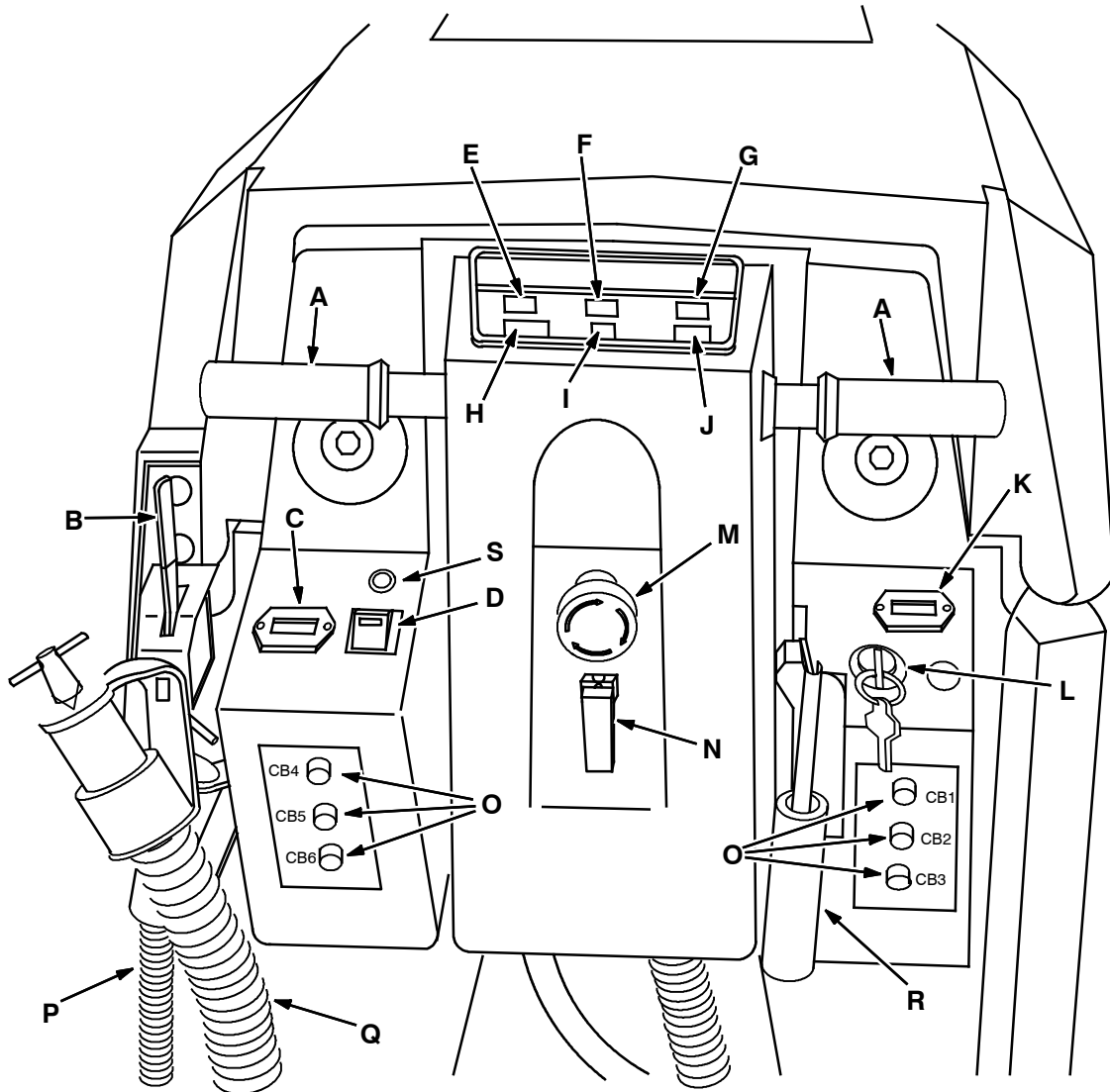

10346

- A. Steering handles
- B. Solution flow lever
- C. Battery discharge indicator
- D. FaST switch (option) or *ec-H2O* switch (option) or Power wand switch (option)
- E. Speed switch and indicator
- F. Squeegee switch
- G. Brush pressure switch and indicator
- H. ES switch (option)
- I. Recovery tank full indicator
- J. Scrubbing switch
- K. Hourmeter
- L. On-off key switch
- M. Power kill switch (option)
- N. Steering height adjustment latch
- O. Circuit breakers
- P. Solution tank hose
- Q. Recovery tank drain hose
- R. Squeegee lever
- S. *ec-H2O* system indicator light (option)

STEERING HANDLES

The steering handles control the machine speed and direction.

Forward: Rotate the handles forward. The further forward you rotate the handles, the faster the machine will go.

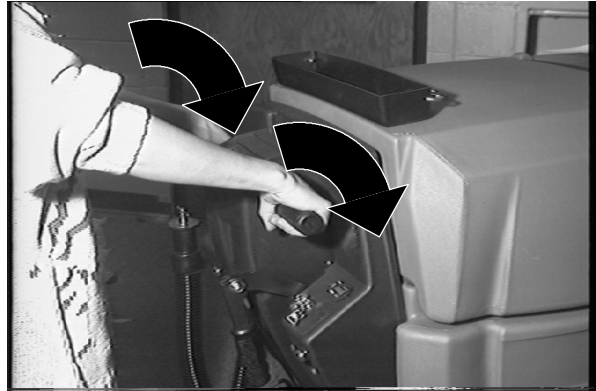

Backward: Rotate the handles toward you.



Turning: Push the machine in the direction of the turn with the steering handles. The machine will turn on the swivel casters.

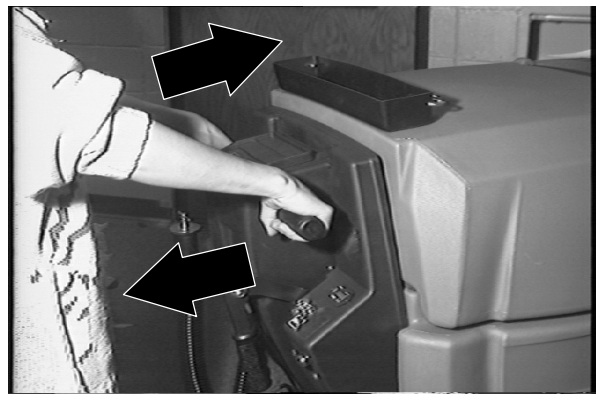

Stopping: Release the handles.



OPERATION

The steering handles and console height is adjustable.

Adjust: Pull up on the height adjustment latch, move the console up or down to the desired height. Then push down the latch to lock the console in position.

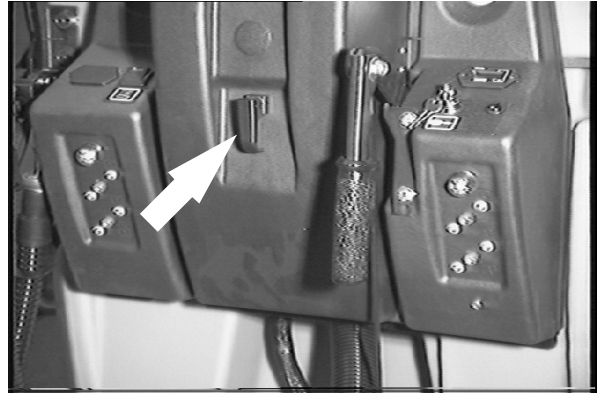

SOLUTION FLOW LEVER

The solution flow lever controls the amount of solution flow to the floor.

Increase: Push the lever forward.

Decrease: Pull the lever backward.

NOTE: A solenoid valve dispenses the solution to the scrub head. The valve opens when the steering handles are rotated forward, and closes when the steering handles are released in neutral position.

NOTE: The solution flow cannot be adjusted when the machine is set for FaST scrubbing or for ec-H2O scrubbing on ec-H2O models manufactured before ec-H2O NanoClean models.

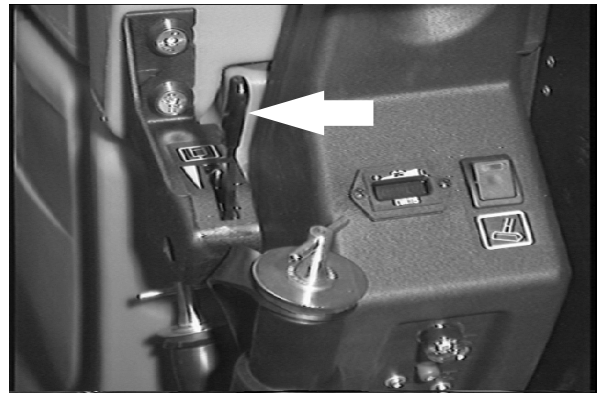

ec-H2O NanoClean SOLUTION FLOW SETTING

(ec-H2O models labeled ec-H2O NanoClean)

To adjust the solution flow rate when ec-H2O scrubbing, press the solution flow button located on the ec-H2O module. One LED= low, two LED's=medium, and three LED's= high. The ec-H2O module is located under the solution tank. Drain solution tank before lifting tank.

NOTE: For ec-H2O models manufactured before ec-H2O NanoClean models, contact an Authorized Service Center if solution flow rate adjustment is required.



POWER WAND SWITCH (OPTION)

The power wand switch turns on and off the power wand solution system.

On: Press the top of the switch. The switch will light up.

Off: Press the bottom of the switch.



OPERATION

SPEED SWITCH AND INDICATOR

The speed switch allows variable maximum forward speed of the machine.

Change speed: Press the switch. Each time you press the switch, the speed will increase until it reaches the maximum setting, then the speed will return to the minimum setting.

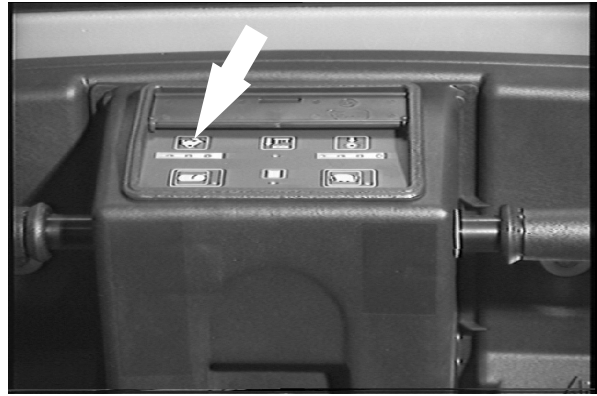

SQUEEGEE SWITCH

The squeegee switch controls the squeegee position and vacuum fan.

Lower squeegee and start vacuum fan: Press the switch.

Raise squeegee and stop vacuum fan: Press the switch.

NOTE: The squeegee will not lower if it is locked in the up position with the squeegee lever.

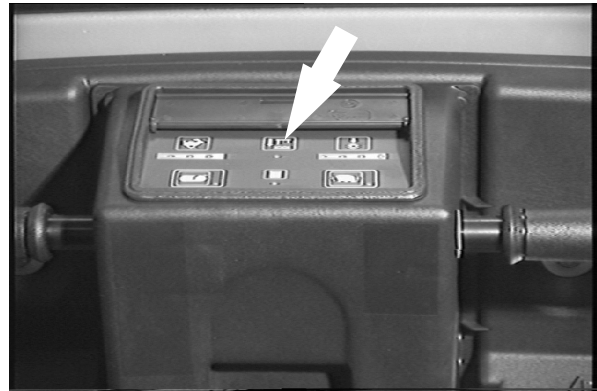

BRUSH PRESSURE SWITCH AND INDICATOR

The brush pressure switch adjusts the amount of brush pressure to the floor. The brush pressure indicator shows the pressure selection.

The brush pressure switch has four positions. Under normal conditions, the brush pressure should be set in the minimum settings. Under heavy grime conditions, the brush pressure should be set in the maximum settings. Travel speed and floor conditions will affect the scrubbing performance.

Change brush pressure: Press the switch. Each time you press the switch, the brush pressure will increase until it reaches the maximum setting. Then the pressure will return to the minimum setting.

NOTE: When the machine is powered off, the brush pressure will remain in the last setting used.

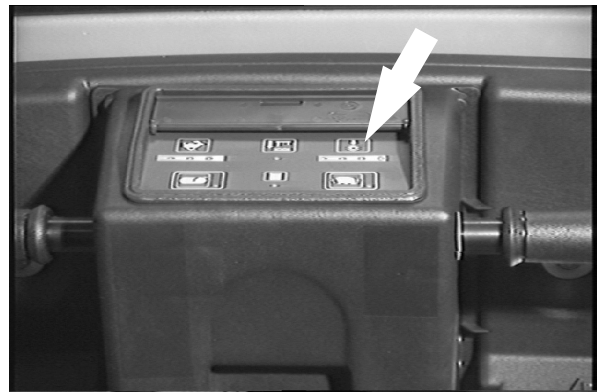

FaST SWITCH (OPTION)

The FaST switch (option) enables the FaST (Foam Scrubbing Technology) system. When the FaST system is enabled, it is turned on and off with the scrub switch.

Enable the FaST system: Press the top of the FaST switch.

Enable conventional scrubbing: Press the bottom of the FaST switch.

NOTE: Disable the FaST system before using the machine for conventional scrubbing.

NOTE: The FaST system will not start until the steering handles are rotated forward or backward.

NOTE: Do not enable the FaST system with conventional cleaning detergents in the solution tank. Drain, raise and refill the solution tank with clear cool water only before operating the FaST system. Conventional cleaning detergents/restorers may cause failure to the FaST solution system.

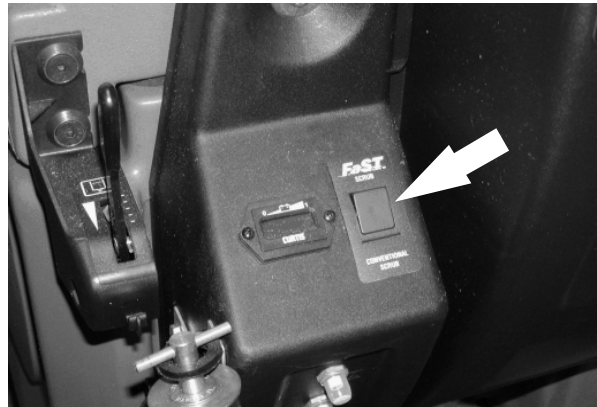

OPERATION

ec-H2O SWITCH (OPTION)

The *ec-H2O* switch (option) enables the *ec-H2O* (electrically converted water) system. When the *ec-H2O* system is enabled, it is turned on and off with the scrub switch.

Enable the *ec-H2O* system: Press the top of the *ec-H2O* switch.

Enable conventional scrubbing: Press the bottom of the *ec-H2O* switch.

NOTE: Disable the ec-H2O system before using the machine for conventional scrubbing.

NOTE: The ec-H2O system will not start until the machine starts scrubbing.

NOTE: Do not enable the ec-H2O system with conventional cleaning detergents in the solution tank. Drain, raise and refill the solution tank with clear cool water only before operating the ec-H2O system. Conventional cleaning detergents/restorers may cause failure to the ec-H2O solution system.

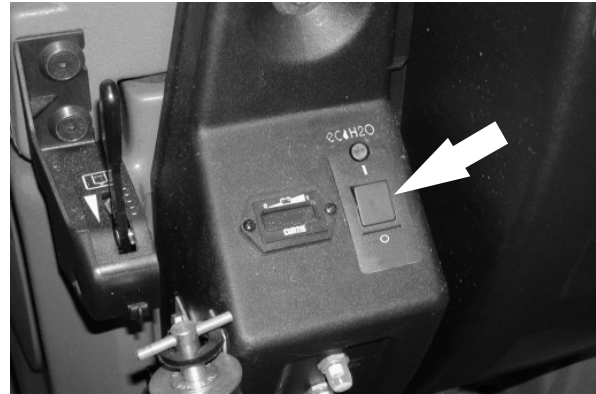

ES SWITCH (OPTION)

The ES switch turns on and off the solution recycling system.

On: Press the switch.

Off: Press the switch.

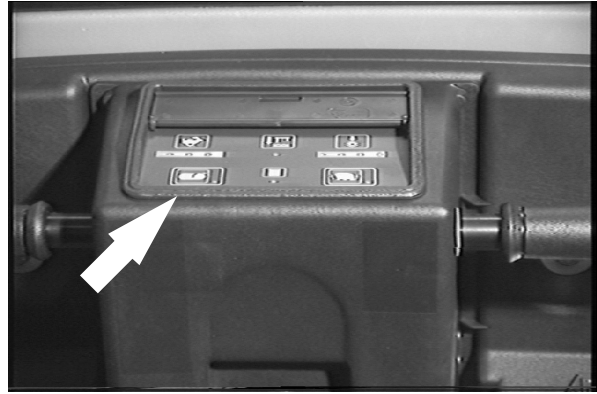
**RECOVERY TANK FULL INDICATOR**

The recovery tank full indicator comes on when the recovery tank is full. When the indicator comes on, the squeegee raises and the vacuum fan shuts off after a short delay.

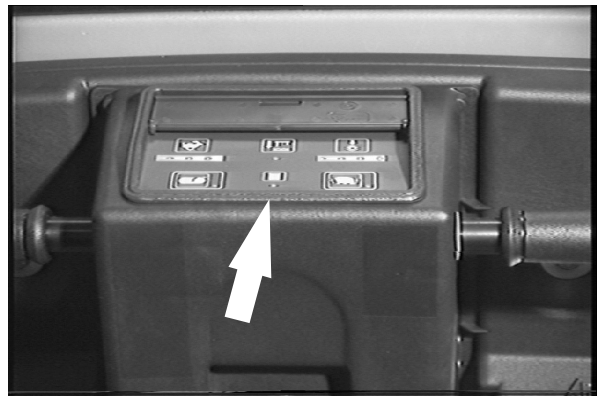

OPERATION

SCRUBBING SWITCH

The scrubbing switch controls the scrub brushes, squeegee and vacuum fan.

Start scrubbing: Press the switch. The indicator light will come on. The scrubbing system will start when the steering handles are rotated forward or backward.

Stop scrubbing: Press the switch. The indicator light will go off. First the scrub brushes stop and raise, then vacuum stops and the squeegee raises.

NOTE: The scrub switch also controls the FaST system (option) when the FaST system is enabled with the FaST switch.

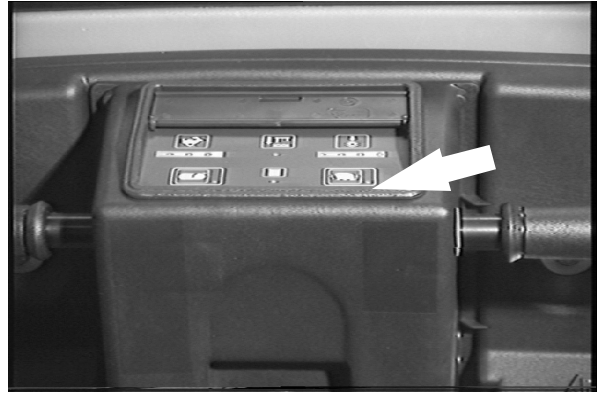

BATTERY DISCHARGE INDICATOR

The battery discharge indicator shows the charge level of the batteries. It displays the charge level when the machine is operating.

When the batteries are fully charged, the indicator on the far right is lit. As the batteries discharge, the indicator will move along the display to the left. The batteries should be recharged when the indicator flashes. The scrub head will raise, and the vacuum fan and brushes will shut off. The propel will operate for a short time to allow the operator to return the machine to the battery charging area.

NOTE: The reading on the battery discharge indicator is not accurate when the machine is first powered on. Operate the machine a few minutes before reading the charge level of the batteries.

NOTE: The battery discharge indicator will not reset from the flashing indicator unless the batteries have been fully charged.



HOURLMETER

The hourmeter records the number of hours the machine has been powered on. This information is useful when servicing the machine.

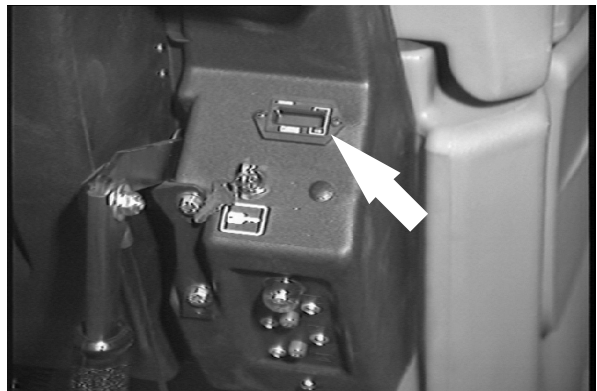

ON-OFF KEY SWITCH

The on-off key switch controls machine power with a key.

On: Turn the key to the right.

Off: Turn the key to the left.

**SQUEEGEE LEVER**

The squeegee lever is used when scrubbing to temporarily lift the squeegee.

Raise squeegee: Pull the lever up, and move it to the right to lock the lever in the up position.

Lower squeegee: Move the squeegee lever up and to the left to unlock it, and then release the lever.

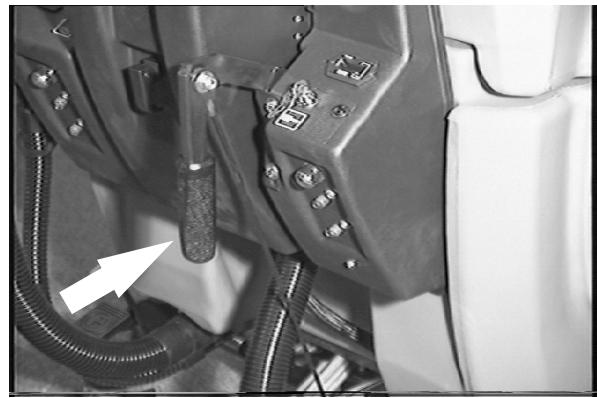
**POWER KILL SWITCH (OPTION)**

The power kill switch halts all power to the machine.

Halt: Hit the power kill switch.

Restart: Turn the power kill switch to the right to release the switch. Turn off the machine power, then turn on the machine power.

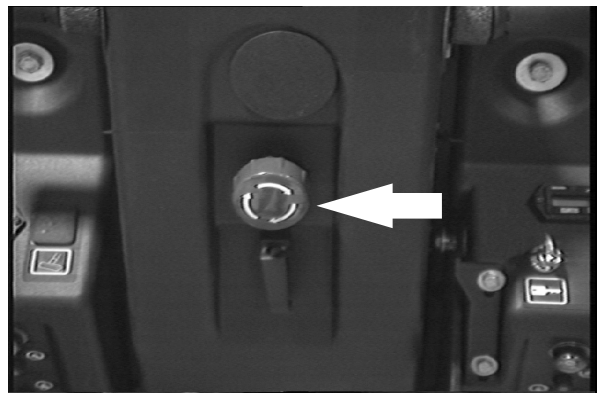

OPERATION

CIRCUIT BREAKERS

The circuit breakers are resettable electrical circuit protection devices. They stop the flow of current in the event of a circuit overload. Once a circuit breaker is tripped, reset manually by pressing the reset button after the breaker has cooled down.

If the overload that caused the circuit breaker to trip is still there, the circuit breaker will continue to stop current flow until the problem is corrected.

The circuit breakers are located on each side of the operator console.

The chart shows the circuit breakers and the electrical components they protect.

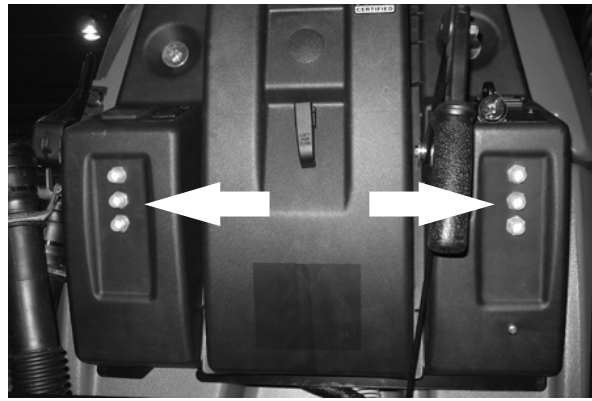

Circuit Breaker	Rating	Circuit Protected
CB1	2.5 A	Machine power
CB2	25 A	Vacuum fan
CB2	40 A	Heavy duty vacuum fan
CB3	25 A	Machine propel
CB4	10 A	Machine controls
CB5	20 A	Scrub brush
CB5	35 A	Heavy duty disk scrub brush
CB6	20 A	Scrub brush
CB6	35 A	Heavy duty disk scrub brush

FUSES (OPTION)

The *fuse* is a one-time protection device designed to stop the flow of current in the event of a circuit overload.

NOTE: Always replace the fuse with a fuse of the same amperage.

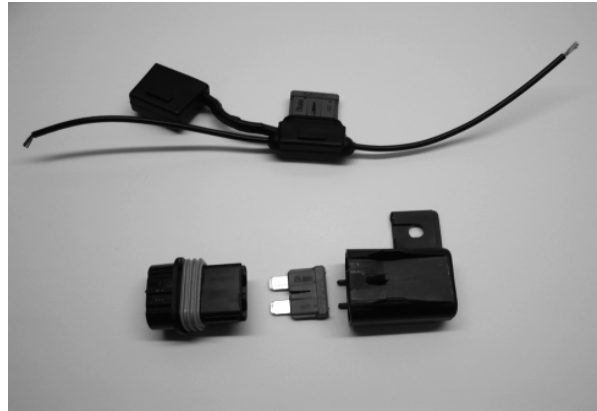

The *fuse* is in-line and located near the air pump on the front of the recovery tank.

Fuse	Rating	Circuit Protected
FU-1	10 A	FaST (option)
FU-1	10 A	ec-H2O (option)

SOLUTION TANK HOSE

The solution tank hose is used to drain the solution tank. The drain hose plug is removed by turning the plug latch to loosen the plug and pulling the plug out of the drain hose. The drain hose is plugged by placing the hose plug in the end of the hose and turning the plug latch to tighten the plug.

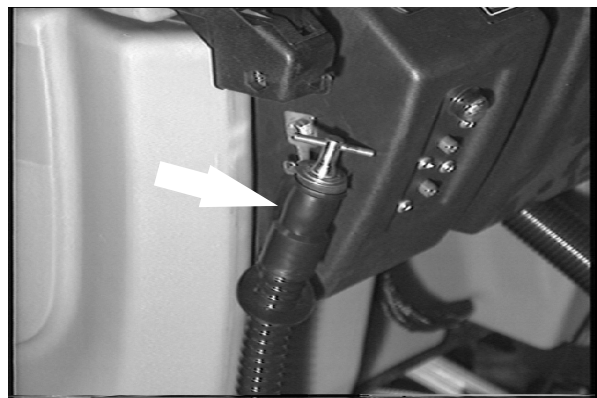

OPERATION

RECOVERY TANK DRAIN HOSE

The recovery tank drain hose is used to drain the recovery tank. The drain hose plug is removed by turning the plug latch to loosen the plug and pulling the plug out of the drain hose. The drain hose is plugged by placing the hose plug in the end of the hose and turning the plug latch to tighten the plug.

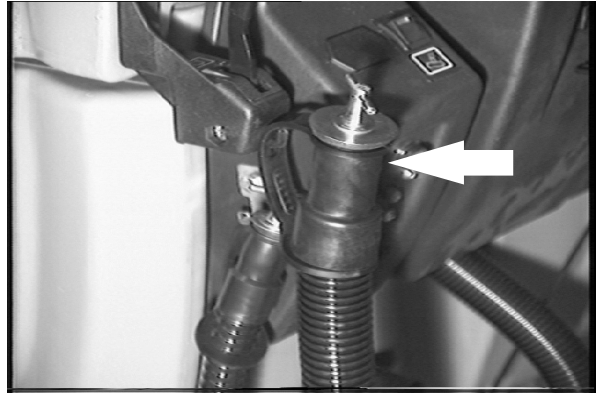

SUPPORT ARM

The support arm holds up the solution tank when the tank is lifted. The support arm engages when the solution tank is lifted all the way open. The arm is released by pulling up on it.

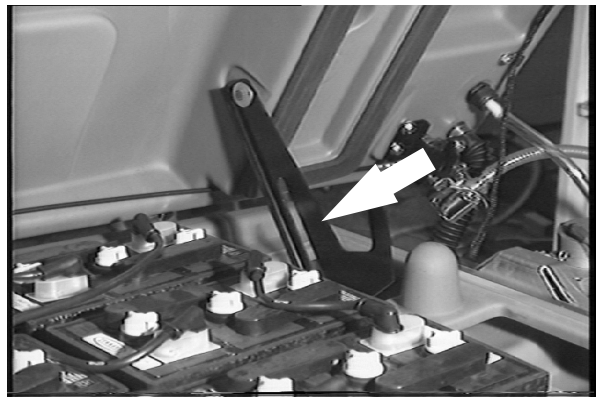

STOP ARM

The stop arm prevents the solution tank from fully closing when the tank is lowered. Push the arm in to lower the solution tank completely.

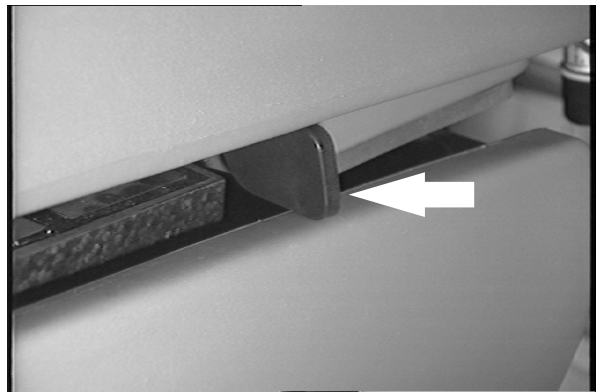

SQUEEGEE DOWN PRESSURE CAMS

The squeegee down pressure cams adjust the squeegee deflection along the entire length of the squeegee.

Increase: Turn the cams clockwise.

Decrease: Turn the cams counter-clockwise.

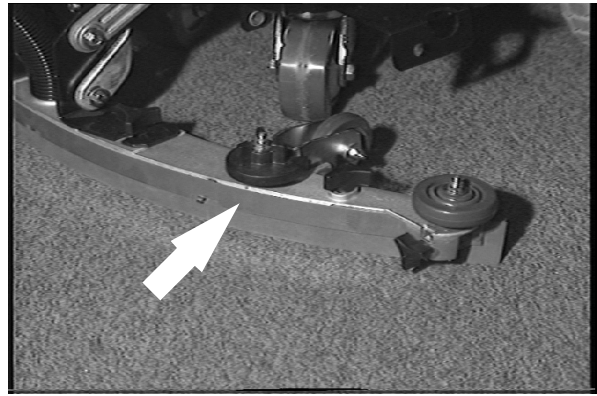

SQUEEGEE LEVELING KNOB

The squeegee leveling knob adjusts the deflection at the ends of the squeegee.

Increase: Turn the squeegee leveling knob counter-clockwise to increase the deflection at the end of the squeegees.

Decrease: Turn the squeegee leveling knob clockwise to decrease the deflection at the end of the squeegees.

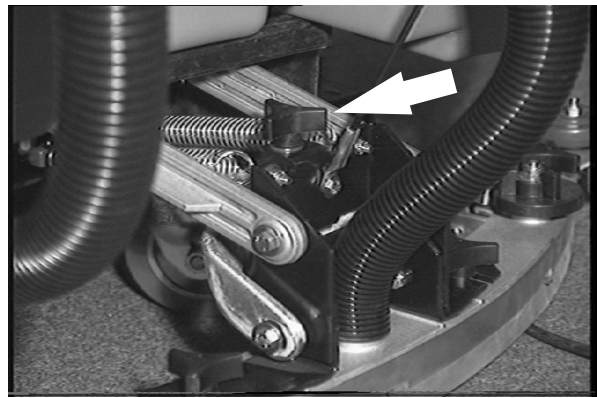

PARKING BRAKE (OPTION)

Models manufactured after serial number 10731451 are equipped with a transaxle that has an electric parking brake system. The electric parking brake will automatically engage when the steering handles are released. The electric parking brake will disengage when steering handles are rotated.

Models manufactured before serial number 10731452 are equipped with a mechanical parking brake mechanism.

The parking brake is controlled with a foot pedal and a release lever located by the squeegee.

Set: Push down on the foot pedal.

Release: Pull up on the release lever.

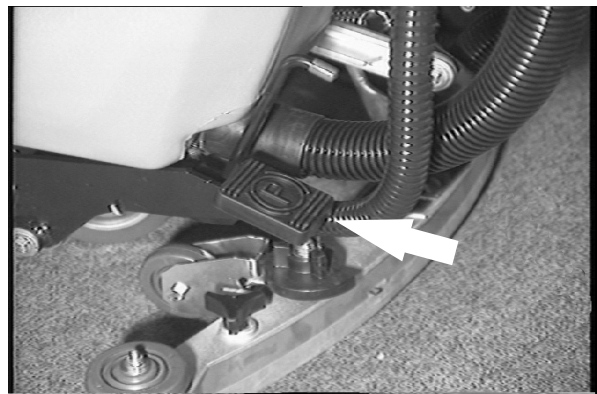

HOW THE MACHINE WORKS

The scrub components of the machine are a solution tank, scrub brushes, a squeegee, a vacuum fan, and a recovery tank.

Water and detergent, from the solution tank, flow to the floor through a solution valve to the scrub brushes. The brushes scrub the floor. As the machine is moved forward the squeegee wipes the dirty solution off the floor, which is then picked up and drawn into the recovery tank.

The steering handles control the direction and speed of the machine in forward or reverse. By rotating the steering handles forward, the machine propels forward. By rotating the handles towards you the machine propels backward.

When using the ES mode, the dirty solution in the recovery tank is filtered and returned to the solution tank to be reused.

Three different widths of scrub heads and squeegees are available for the machine, along with two different brush types.

The scrub head widths are as follows; the model 700 (700 mm (28 in)), the model 800 (800 mm (32 in)), and the model 900 (900 mm (36 in)). The 700 mm (28 in) squeegee is used with the 700 model scrub head, as well as the 800 mm (32 in) with the model 800, and the 900 mm (36 in) with the model 900. The two available brush types are disk and cylindrical.



FaST SCRUBBING SYSTEM (OPTION)

The FaST (Foam Scrubbing Technology) system operates by injecting the FaST PAK concentrate agent (A) into the system with a small amount of water and compressed air. This mixture creates a large volume of expanded wet foam.

The expanded foam mixture is then dispersed onto the floor (B) while the machine is scrubbing. When the squeegee picks up the mixture, the patented foaming agent has collapsed and is recovered into the recovery tank.

The FaST system can be used with all double scrubbing and heavy duty scrubbing applications.

Using the FaST system can increase productivity by 30% by reducing your dump/fill cycle. It will also reduce chemical usage and storage space. One FaST PAK of concentrated agent can scrub up to 1 million sq. ft.

NOTE: Do not enable the FaST system with conventional cleaning detergents in the solution tank. Drain, raise and refill the solution tank with clear cool water only before operating the FaST system. Conventional cleaning detergents/restorers may cause failure to the FaST solution system.

NOTE: Storage or transporting machines equipped with FaST in freezing temperatures requires special procedures. Check with a TENNANT representative for advice.

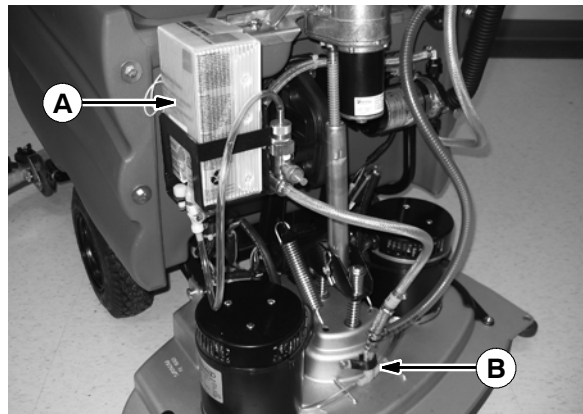

FaST
Foam Scrubbing Technology®

The Safe Scrubbing Alternative®

OPERATION

ec-H₂O NanoClean SCRUBBING SYSTEM (ec-H₂O Model)

When using the ec-H₂O NanoClean technology, normal water passes through a module where it is electrically converted into a cleaning solution. The electrically converted water attacks the dirt, allowing the machine to easily scrub away the suspended soil. The converted water then returns to normal water in the recovery tank.

The ec-H₂O system can be used with all double scrubbing applications.

NOTE: Do not enable the ec-H₂O system with conventional cleaning detergents in the solution tank. Drain, raise and refill the solution tank with clear cool water only before operating the ec-H₂O system. Conventional cleaning detergents/restorers may cause failure to the ec-H₂O solution system.

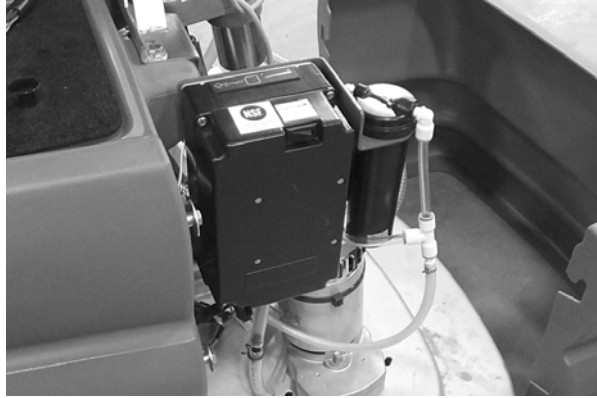

BRUSH AND PAD INFORMATION

For best results, use the appropriate brush or pad for the cleaning application. Listed below are brushes and pads and the applications for which each is best suited.

NOTE: The amount and type of soilage play an important role in determining the type of brush or pad to use. Contact a Tennant representative for specific recommendations.

Polypropylene brush (Cylindrical and Disk) - General purpose polypropylene bristles lift lightly compacted dirt without scuffing high-gloss coated floors.

Nylon brush (Cylindrical and Disk) - Softer nylon bristles are recommended for scrubbing coated floors. Cleans without scuffing.

Super AB brush (Cylindrical and Disk) - Nylon fiber with an abrasive grit to remove stains and compacted dirt. Aggressive action on any surface. Performs well on buildup, grease, or tire marks.

High productivity stripping pad (Black) - For aggressive stripping of heavy finishes or sealers, or for very heavy duty scrubbing. *This pad can only be used with the grip pad driver, not the tufted pad driver.*

Stripping pad (Brown)- For stripping of floor finish to prepare the floor for recoating.

Scrubbing pad (Blue) - For medium to heavy-duty scrubbing. Removes dirt, spills, and scuffs.

Buffing pad (Red) - For light duty scrubbing without removing floor finish.

Polishing pad (White) - For maintaining highly polished or burnished floors.

PRE-OPERATION CHECKLIST

Check over this list of items before operating the machine:

- Check the battery fluid and charge level.
- Check the tank cover seals for damage and wear.
- Clean the vacuum fan inlet filter.
- Check the condition of the scrubbing brushes. Remove any string, banding, plastic wrap, or other debris wrapped around them.
- Check the squeegees for damage, wear and for deflection adjustment.
- Check the vacuum hose for debris or blockage.
- ES machines; check the detergent tank level.
- Drain and clean the recovery tank.
- ES machines; drain and clean the solution tank and ES filter. Rinse level sensors.
- Empty and clean the debris tray (if applicable).
- Check the service records to determine maintenance requirements.
- FaST Scrubbing:** Check the FaST PAK (option) concentrate agent level, replace carton as needed. See the INSTALLING THE FaST PAK AGENT section of the manual.
- FaST or ec-H₂O Scrubbing:** Check that all conventional cleaning agents/restorers are drained and rinsed from the solution tank.
- FaST or ec-H₂O Scrubbing:** Check that the solution tank is filled with **clear cool water only**.

ec-H2O NanoClean WATER CONDITIONING CARTRIDGE (ec-H2O NanoClean Model)

(ec-H2O models labeled ec-H2O NanoClean)

The ec-H2O system is equipped with a water conditioning cartridge. The cartridge is designed to protect the machine's plumbing system from potential scaling. The cartridge is located at front of machine behind shroud.

The cartridge is required to be replaced when it reaches its maximum water usage or expiration time of when the cartridge was activated, which ever comes first.

Depending on machine usage a new cartridge can last anywhere from 12 to 24 months.

All cartridges are labeled with a manufacture date. The shelf-life of an un-installed cartridge is one year from manufacture date. For new cartridge replacement, the ecH2O module timer must be reset. See ec-H2O NanoClean WATER CONDITIONING CARTRIDGE REPLACEMENT.

ATTENTION: *During first time use and after replacing the water conditioning cartridge, the ec-H2O system will automatically override the selected solution flow rate for up to 75 minutes.*

The ec-H2O system indicator light will blink green/red when it's time to replace cartridge.

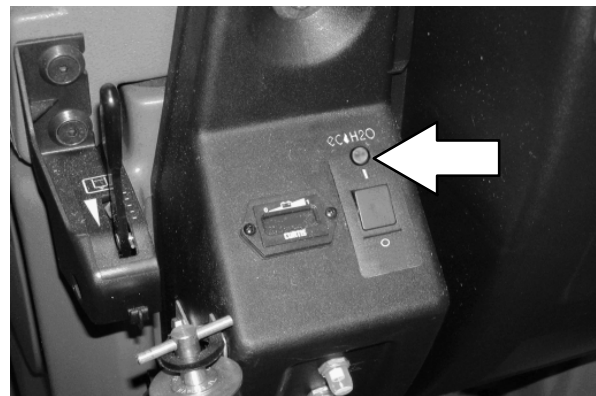

OPERATION

INSTALLING FaST PAK AGENT (OPTION)

NOTE: Machine must be equipped with the FaST option before the FaST PAK agent can be installed.

1. Remove the perforated knock-outs from the FaST PAK Floor Cleaning Concentrate carton. Do not remove the bag from the carton. Pull out the bag's hose connector on the bottom of the bag and remove the hose cap from the connector.

NOTE: The FaST PAK Floor Cleaning Concentrate is specifically designed for use with the FaST system scrubbing application. NEVER use a substitute, machine damage will result.

FOR SAFETY: When using machine, always follow the handling instructions on chemical container.

2. Empty the solution tank. See the DRAINING AND CLEANING THE TANKS section of the manual.

NOTE: When scrubbing with the FaST system option, use clean water only. Do not add cleaning agents/restorers in the solution tank. Conventional cleaning agents/restorers may cause failure to the FaST solution system..

3. Raise the solution tank and remove the front cover to access the FaST PAK carton.



- Place the FaST PAK carton in the carton holder under the front cover of the machine. Connect the supply hose to the FaST PAK bag.

NOTE: If any dried concentrate is visible on the supply hose connector or the on the FaST PAK connector, soak and clean with warm water.

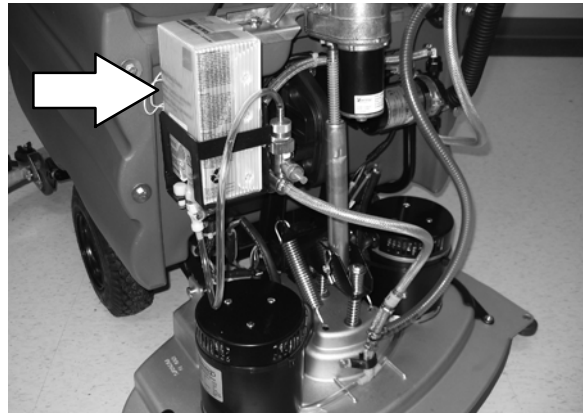

- Make sure to connect the supply hose onto the hose storing plug when the supply hose is not connected to the FaST PAK. This will prevent the FaST solution system from drying out and clogging up the hose.

- When replacing an empty FaST PAK carton, allow the new FaST PAK detergent to gravity feed into the system for several minutes prior to operating the FaST system. If the detergent does not flow out of the FaST PAK, simply squeeze and release the hose several times. If the previous FaST PAK was run dry, it may take up to 3 minutes of operation to remove any air pockets in the system before you achieve maximum foaming.

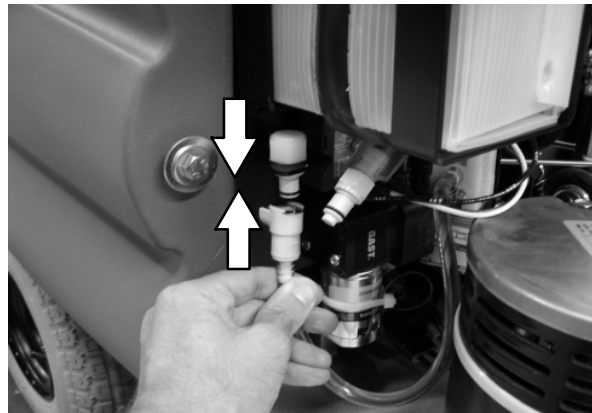

OPERATION

STARTING THE MACHINE

- 1 Turn the machine power on.

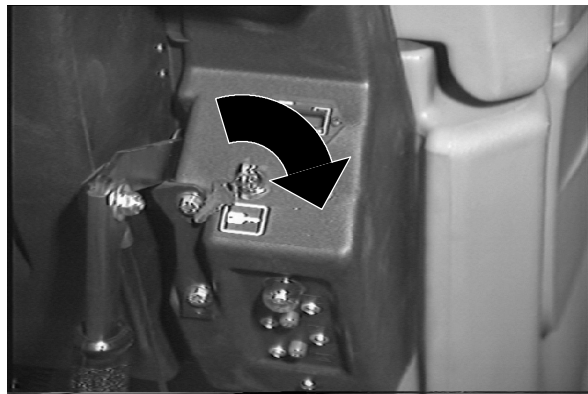

- 2 Release the machine parking brake, if your machine has this option.

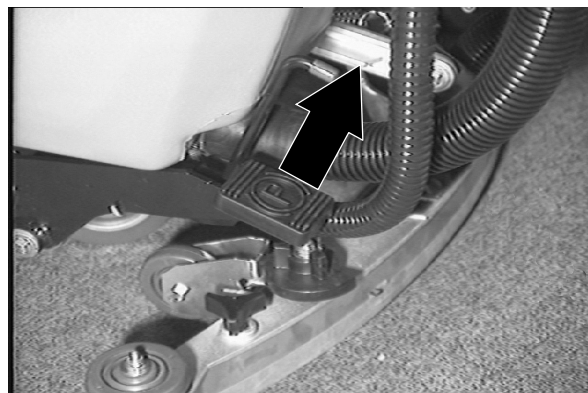

FILLING THE TANKS

6. Start the machine.
7. Drive the machine to the filling site.



8. Turn the machine power off.

FOR SAFETY: Before leaving or servicing machine, stop on level surface, set parking brake (if so equipped), turn off machine, and remove key.

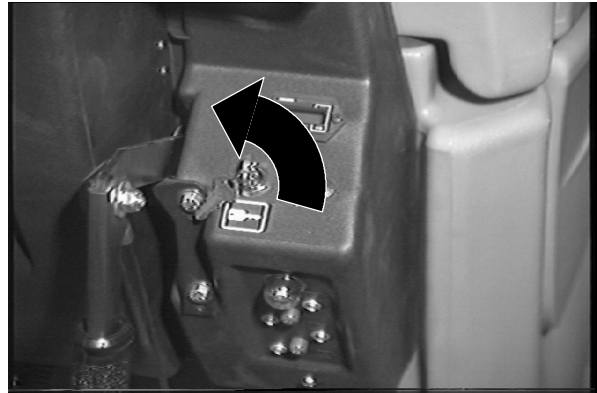

9. Set the parking brake, if your machine has this option.

NOTE: If you are going to scrub in the ES mode, the recovery tank can be partially filled to extend scrub time. Make sure the ES system is on.

*If you **do not** want to use the ES system, make sure the ES system is off. **DO NOT** fill the recovery tank.*

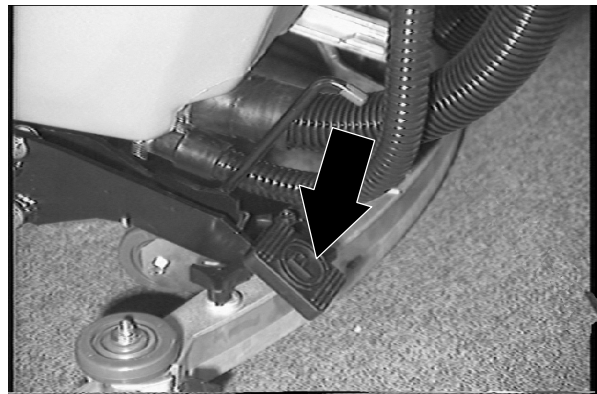

10. ES mode: Lift up the solution tank. Fill the recovery tank with water 50 mm (2 in) below the top of the ES filter located on the bottom of the tank, approximately 87 L (23 gal) of water.

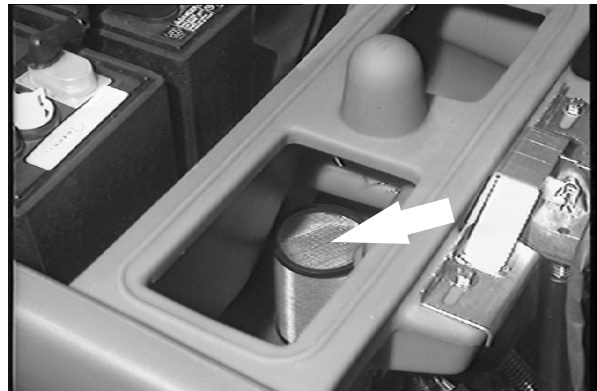

OPERATION

11. ES mode: Lower the solution tank.



12. CONVENTIONAL SCRUBBING: Open the solution tank cover and partially fill the solution tank with water. Pour the required amount of detergent into the solution tank fill opening. Continue filling the solution tank with water 25 mm (1 in) below the bottom of the solution fill opening channel.

FOR SAFETY: Follow mixing and handling instructions on chemical containers.

13. FaST or *ec-H₂O* SCRUBBING: Open the solution tank cover and fill the solution tank with clear cool water only.

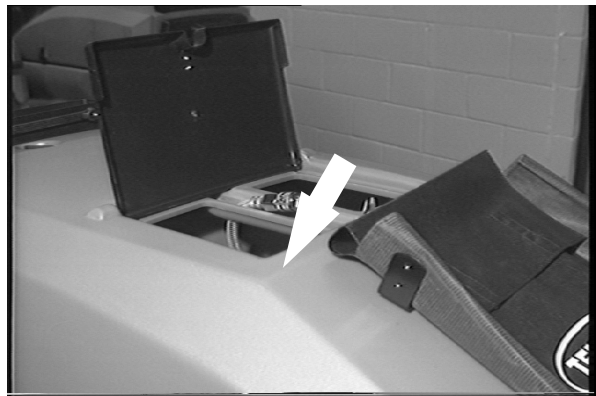

NOTE: When cleaning using the FaST or *ec-H₂O* option, USE CLEAR COOL WATER ONLY. DO NOT add cleaning agents in solution tank. Conventional cleaning agents/restorers may cause failure to the system.

*NOTE: (For conventional scrubbing)
Floor conditions, water condition, amount of soilage, types of soilage, and brush action all play an important role in determining the type and concentration of detergent used. For specific recommendations, contact your Tennant representative.*



WARNING: Flammable materials can cause an explosion or fire. Do not use flammable materials in tank(s).

WHILE OPERATING THE MACHINE

- Pick up oversized debris before scrubbing. Pick up pieces of wire, string, twine, etc., which could become wrapped around the scrub brush.
- Plan the scrubbing in advance. Try to arrange long runs with minimum stopping and starting. Do an entire floor or section at one time.
- Try to scrub as straight a path as possible. Avoid bumping into posts or scraping the sides of the machine. When scrubbing dead end aisles, start at the closed end of the aisle and scrub your way out. Overlap the scrub paths by a few centimeters (inches).
- If you see poor scrubbing performance, stop scrubbing and refer to *MACHINE TROUBLESHOOTING*.



0721E

SCRUBBING

1. Start the machine.
2. Drive the machine to the area to be scrubbed.



OPERATION

3. FaST SCRUBBING: Press the top of the FaST switch to start the FaST system.

NOTE: When using the FaST system (option), the solution flow lever is nonfunctional. The FaST system flow rate is pre-set.

NOTE: Leave the FaST switch in the CONVENTIONAL SCRUBBING position if not using the FaST system.

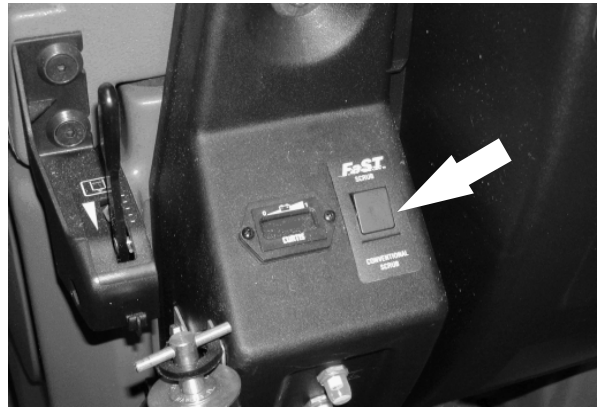

ec-H2O SCRUBBING: Press the top of the ec-H2O switch to start the ec-H2O system.

NOTE: Leave the ec-H2O switch in the CONVENTIONAL SCRUBBING position if not using the ec-H2O system.

NOTE: The ec-H2O system indicator light will not turn on until the machine starts scrubbing.

ec-H2O NanoClean Models (ec-H2O models labeled ec-H2O NanoClean)

ATTENTION: During first time use and after replacing the water conditioning cartridge, the ec-H2O system will automatically override the selected solution flow rate for up to 75 minutes.

If the ec-H2O system indicator light begins to blink green/red, the water conditioning cartridge needs to be replaced (See ec-H2O NanoClean WATER CONDITIONING CARTRIDGE REPLACEMENT).

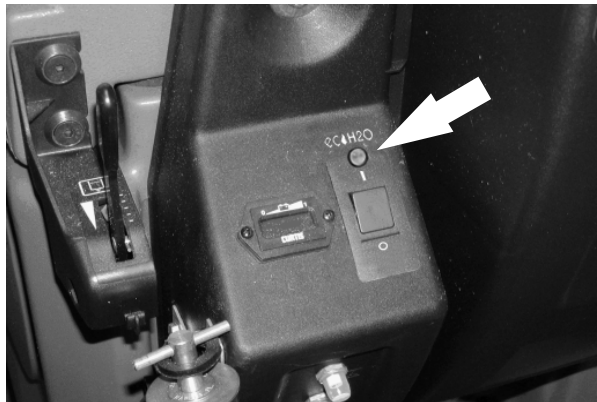
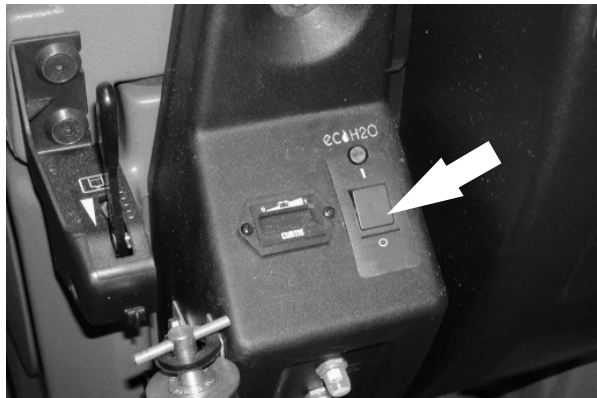

ec-H2O SYSTEM INDICATOR LIGHT CODE	CONDITION
Solid green	Normal operation
Blinking green/red	Water conditioning cartridge expired. Replace cartridge.
Solid red	Contact Service Center

**ec-H2O Models
(ec-H2O models manufactured before ec-H2O
NanoClean models)**

ec- H2O SCRUBBING: If an alarm sounds and the *ec- H2O* system indicator light begins to blink red, the *ec- H2O* module must be flushed to resume *ec- H2O* operation (See *ec- H2O* MODULE FLUSH PROCEDURE)

NOTE: When the alarm sounds and the light blinks red, the machine will bypass the *ec- H2O* system. To continue scrubbing, turn the *ec- H2O* switch off and change over to conventional scrubbing.

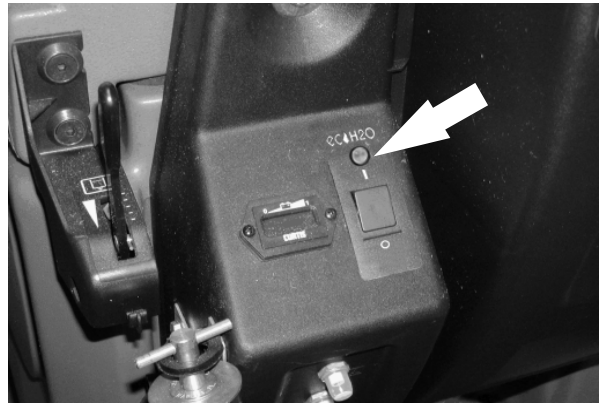

ec- H2O SYSTEM INDICATOR LIGHT CODE	CONDITION
Solid green	Normal operation
Blinking red	Flush <i>ec- H2O</i> module
Solid red	Contact Service Center

OPERATION

4. Press the scrubbing switch.

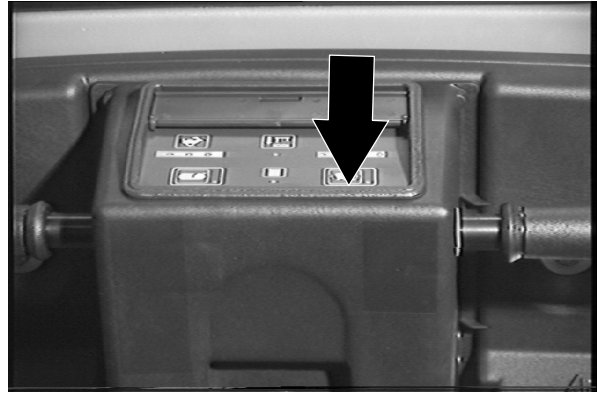

6. Adjust the solution flow to the floor as needed.

NOTE: The solution flow cannot be adjusted when the machine is set for FaST scrubbing or for ec-H2O scrubbing on ec-H2O models manufactured before ec-H2O NanoClean models.

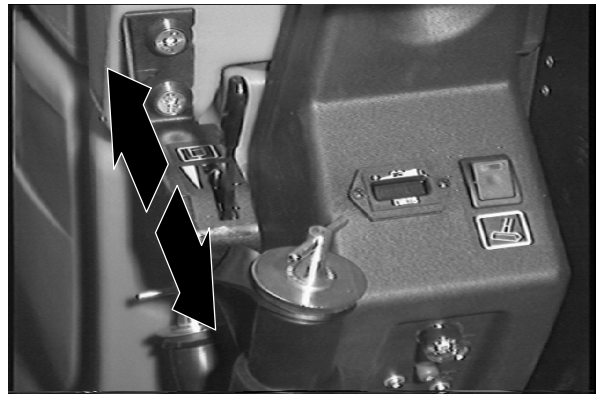

7. Drive the machine forward and scrub as required.

⚠ WARNING: Flammable materials or reactive metals can cause an explosion or fire. Do not pickup.



DOUBLE SCRUBBING

Double scrubbing is a method for removing heavy floor accumulations. This is done by making two passes over the area to be cleaned with the machine.

Double scrubbing can be performed using the FaST SCRUBBING SYSTEM (option), *ec-H₂O* SCRUBBING SYSTEM (option) or CONVENTIONAL SCRUBBING methods.

First, make a pass over the area scrubbing with the squeegee up. This dispenses solution over the area allowing the solution to soak on the floor. Let the solution remain on the floor for 15 to 20 minutes. Then make a second pass scrubbing with the squeegee down.

FOR SAFETY: When using machine, go slow on inclines and slippery surfaces.

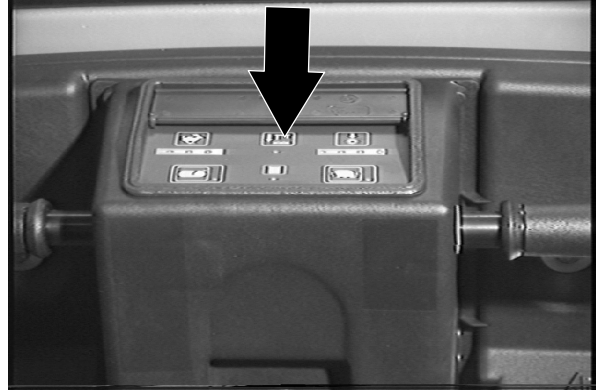

OPERATION

STOP SCRUBBING

1. Release the steering handles.



2. Press the scrubbing switch.

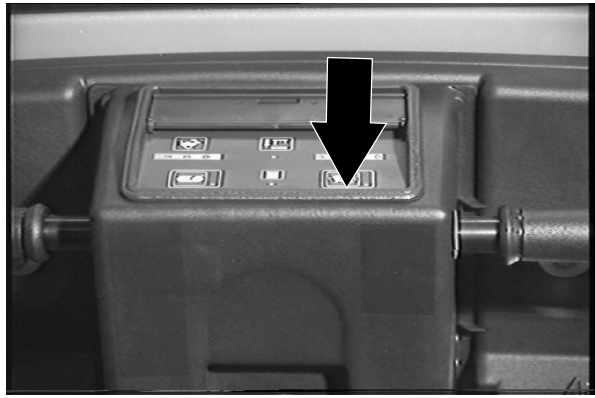

DRAINING AND CLEANING THE TANKS

When you are finished scrubbing, or when the recovery tank full indicator comes on, the recovery tank should be drained and cleaned. The solution tank then can be filled again for additional scrubbing.

If you used the machine in ES mode, the solution tank should also be drained and cleaned when you are finished scrubbing.

1. Stop scrubbing.
2. Drive the machine next to a floor drain or sink.



3. Turn the machine power off.

FOR SAFETY: Before leaving or servicing machine, stop on level surface, and turn off machine.

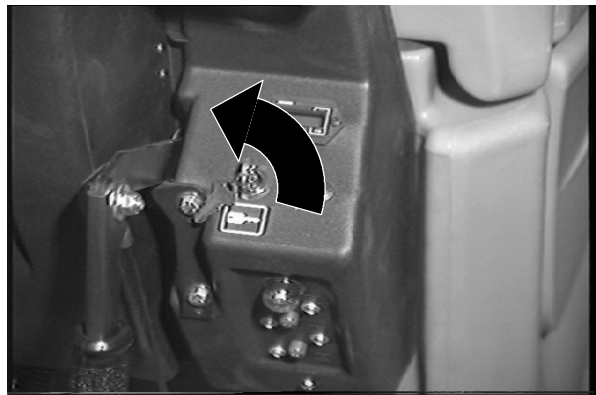

4. Set the parking brake, if your machine has this option.

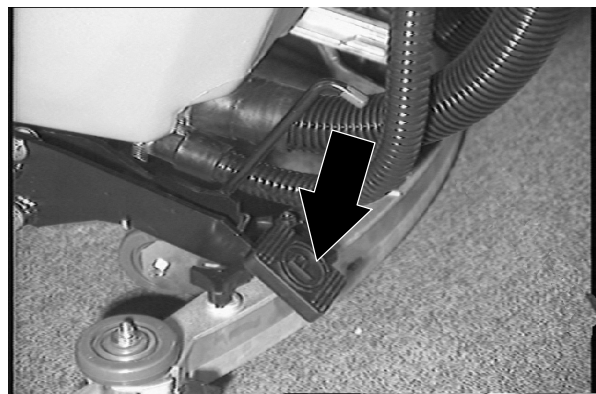

OPERATION

5. ES mode: Remove the solution tank drain hose from the mounting clip.

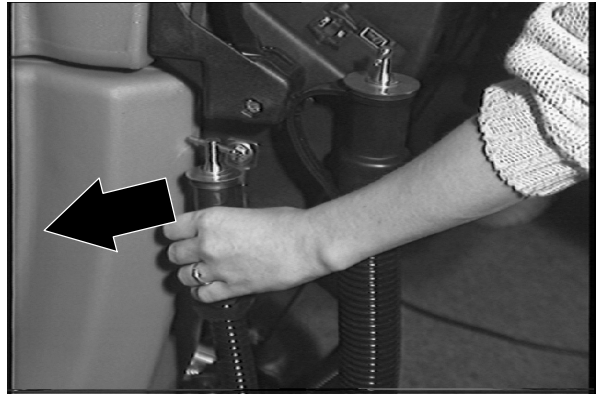

6. ES mode: Remove the drain hose plug while holding the hose up, then slowly lower the drain hose to the floor drain.



7. ES mode: Lift the solution tank cover and flush out the solution tank with clean water through the fill opening and the top access hole. Rinse the filter(s) at the bottom of the solution tank.

NOTE: *Do not* use steam to clean the tank.

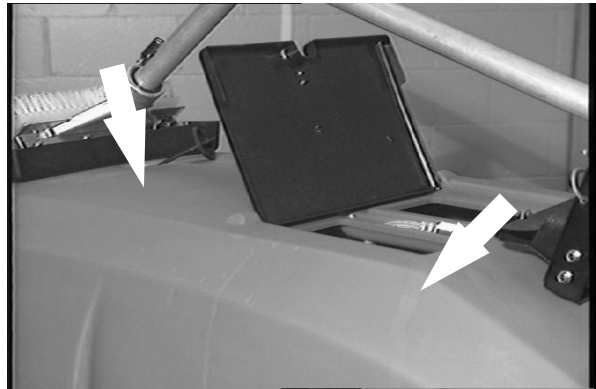

8. ES mode: When the solution tank has completely drained, replace the drain hose plug in the solution tank drain hose and place the solution tank drain hose back onto the mounting clip on the machine.

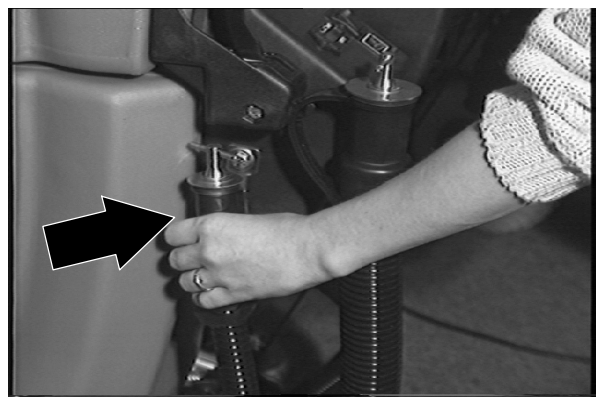

9. Remove the recovery tank drain hose from the mounting clip.

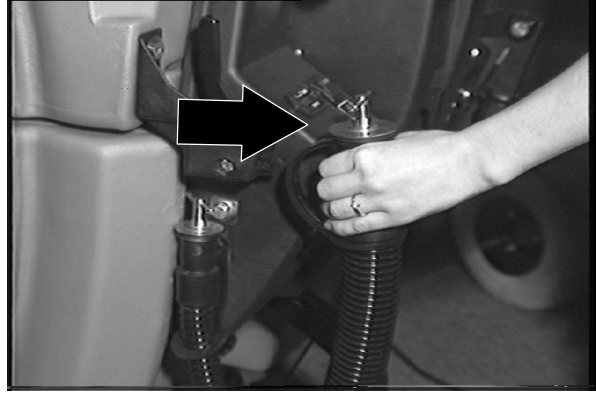

10. Remove the drain hose plug while holding the hose up, then slowly lower the drain hose to the floor drain or sink.



11. Lift the solution tank to reach the recovery tank.



12. Flush out the inside of the recovery tank with clean water.

NOTE: *Do not* use steam to clean the tank.



OPERATION

13. ES mode: Rinse the ES filter.

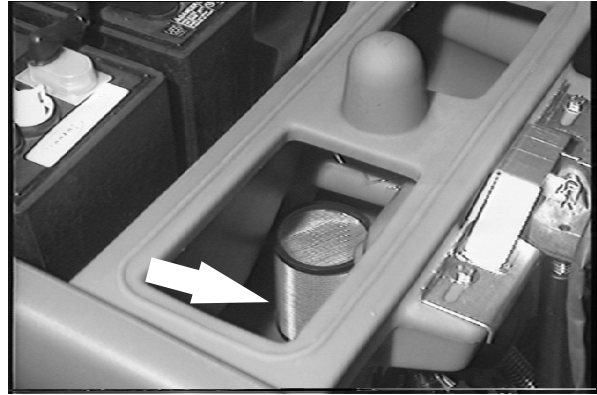

14. Rinse and wipe off the level sensor(s) on the side of the recovery tank.

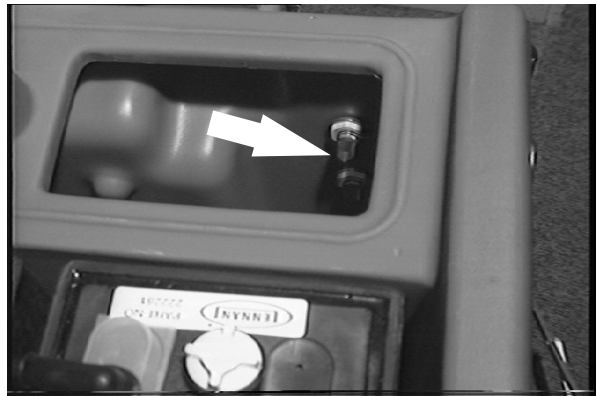

15. Remove and clean the vacuum fan filter located in the recovery tank. Clean by shaking dust or rinsing pleats with low pressure water. Insert the filter back in to the recovery tank when finished.

NOTE: Be sure the vacuum filter is dry before reinstalling it in the machine.

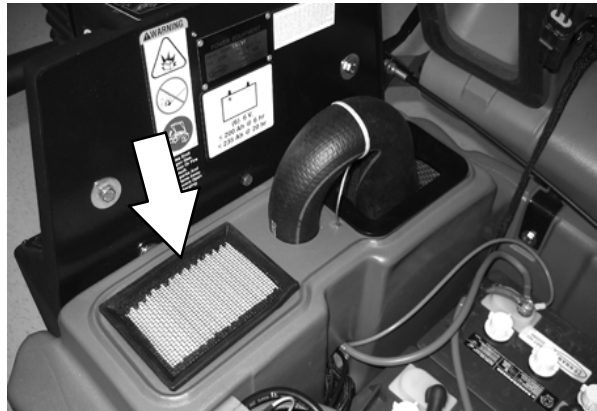

16. An optional debris screen is available for the recovery tank entry. If your machine is equipped with this screen, remove and clean it daily.



17. When the tank has completely drained, replace the drain hose plug in the recovery tank drain hose. Place the recovery tank drain hose back onto the mounting clip on the machine.

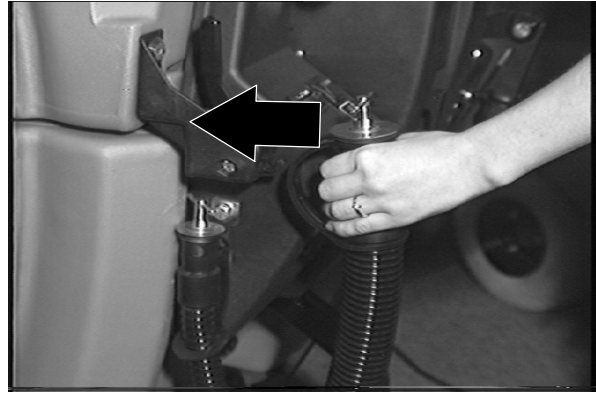

18. Pull up on the support arm and lower the solution tank. Push the stop arm in to completely lower the solution tank.



19. Cylindrical scrub head: Remove and clean the debris trough. Place the trough back in the scrub head.

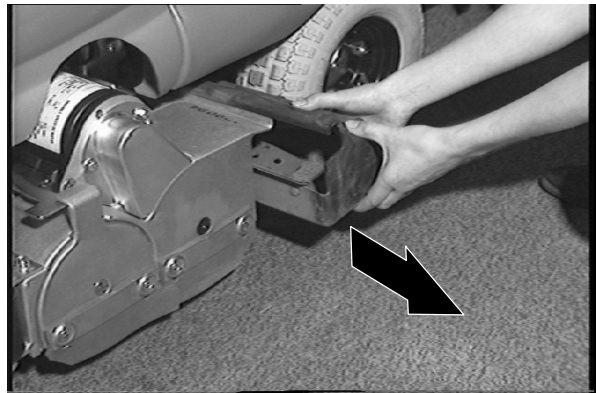

OPERATION

STOP THE MACHINE

1. Stop scrubbing.
2. Turn the machine power off.

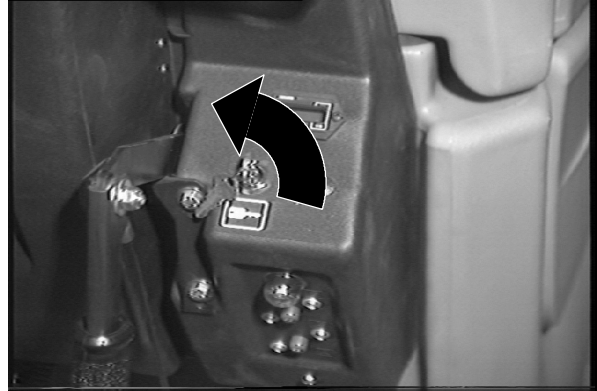

3. Set the parking brake, if your machine has that option.

FOR SAFETY: Before leaving or servicing machine, stop on level surface, set parking brake (if so equipped), turn off machine, and remove key.

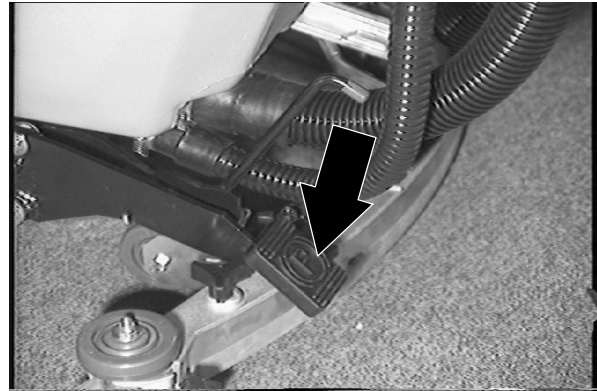

OPERATION ON INCLINES

Drive the machine slowly on inclines.

FOR SAFETY: When using machine, go slow on inclines and slippery surfaces.

The maximum rated climb and descent incline with empty tanks is 8°, with full tanks is 6°.

POST-OPERATION CHECKLIST

Check over this list of items after you have finished scrubbing with the machine powered on:

- Check the battery fluid and charge level.

NOTE: The reading on the battery discharge indicator is not accurate when the machine is first powered on. Operate the machine a few minutes before reading the charge level of the batteries.

Check over this list of items with the machine powered off:

- Check the tank cover seals for damage and wear.
- Clean the vacuum fan inlet filter.
- Check the condition of the scrubbing brushes. Remove any string, banding, plastic wrap, or other debris wrapped around them.
- Check the squeegees for damage, wear and for deflection adjustment.
- Check the vacuum hose for debris or blockage.
- ES machines; check the detergent tank level.
- Drain and clean the recovery tank.
- ES machines; drain and clean the solution tank and ES filter. Rinse level sensors.
- Empty and clean the debris tray. (if applicable).
- Check the service records to determine maintenance requirements.
- FaST scrubbing: If FaST PAK is empty after scrubbing, install a new FaST PAK or connect supply hose to the storage plug.

OPERATION

MACHINE TROUBLESHOOTING

Problem	Cause	Remedy	
Trailing water - poor or no water pickup	Worn squeegee blades	Rotate or replace squeegee blades	
	Squeegee out of adjustment	Adjust squeegee	
	Vacuum hose clogged	Flush vacuum hoses	
	Vacuum fan filter dirty	Clean inlet filter	
	Debris caught on squeegee	Remove debris	
	Vacuum hose to squeegee or recovery tank disconnected or damaged	Reconnect or replace vacuum hose	
	Solution tank not completely closed	Check for obstructions	
		Heavy duty batteries posts too tall, file down posts	
Machine front cover mounted too high, mount cover lower			
Torn seals on solution tank	Replace seals		
Vacuum fan will not turn on	Recovery tank full	Drain recovery tank	
	Foam filling recovery tank	Empty recovery tank	
		Use less or change detergent	
		Use a defoamer	
Vacuum fan circuit breaker tripped	Reset circuit breaker		
Vacuum fan will not turn on, optical sensor(s)	Recovery tank full sensor(s) dirty	Clean sensor(s) and reset key switch	
	Oily/ink film buildup on recovery tank sensor(s)	Use correct detergent	
		Change to magnetic sensor(s)	
Operating in bright sunlight	Install sensor sun shield(s)		
Little or no solution flow to the floor	Solution tank empty	Fill solution tank	
	Solution control cable broken or out of adjustment	Replace and/or adjust cable	
	Solution flow turned off	Turn solution flow on	
	Solution supply lines plugged	Flush solution supply lines	
	Solution supply line filter dirty	Clean filter	
	Solution solenoid clogged or stuck	Clean or replace	
	ES mode: ES switch off	Turn ES switch on	
Poor scrubbing performance	Debris caught on scrub brushes	Remove debris	
	Improper detergent, brush, or pad used	Contact Service Center	
	Worn scrub brush(es) or pad(s)	Replace scrub brush(es) or pad(s)	
	Scrub brush motor circuit breaker(s) tripped	Reset circuit breaker(s)	
		Reduce scrub brush down pressure	
		Uneven brush pressure, level scrub head	
		Broken brush drive belts on cylindrical scrub head, replace belt	
	Contact Service Center		
	Low battery charge	Charge batteries until the charger automatically turns off	
	Tire pressure low	Increase tire pressure	

Problem	Cause	Remedy
Poor propelling traction	Brush pressure set too high	Decrease brush pressure
	Tires slip on oily or waxed floors	Contact Service Center
	Uneven brush down pressure	Level scrub head Broken brush drive belts on cylindrical scrub head, replace belt
FaST System (option) does not operate	FaST switch is set for Conventional scrubbing	Set the FaST switch for FaST system scrubbing
	FaST fuse blown	Determine cause and replace the 10A fuse
	Clogged FaST PAK supply hose and/or connectors	Soak connector and hose in warm water and clean
	FaST PAK carton is empty or not connected	Replace FaST PAK carton and/or connect supply hose
	Clogged flow control orifice and/or screen	Remove and clean orifice and/or screen
	Faulty pump or air compressor	Contact Service Center
	Clogged filter screen	Drain solution tank, remove and clean filter screen
	FaST system is not primed	To prime, operate the FaST solution system for 3 minutes.

ec-H2O NanoClean Models (ec-H2O models labeled ec-H2O NanoClean)

Problem	Cause	Remedy
ec-H2O system indicator light blinking green/red	Water conditioning cartridge has expired	Replace cartridge (See ec-H2O NanoClean WATER CONDITIONING CARTRIDGE REPLACEMENT)
ec-H2O system indicator is red or blinking* red	ec-H2O system fault has been detected	Contact Service Center

**Verify if cleaning detergent was added to solution tank. If ec-H2O system was operated with cleaning detergent, drain solution tank, add clear water and operate the ec-H2O system until the indicator light code clears.*

ec-H2O Models (ec-H2O models manufactured before ec-H2O Nanoclean models)

Problem	Cause	Remedy
ec-H2O system indicator light blinking red	Mineral deposit build-up in module	Flush module (See ec-H2O MODULE FLUSH PROCEDURE)
Alarm sounds		
ec-H2O system indicator light solid red	Defective module	Contact Service Center
ec-H2O system indicator light does not turn on	Defective light or module	Contact Service Center
No water flow	Clogged module	Contact Service Center
	Defective solution pump	Replace solution pump

OPTIONS

VACUUM WAND

The vacuum wand uses the machine's vacuum system. The vacuum hose allows pick-up of spills that are out of reach of the machine.

 **WARNING: Flammable materials or reactive metals can cause an explosion or fire. Do not pickup.**

1. Turn the machine power off.

FOR SAFETY: Before leaving or servicing machine, stop on level surface, and turn off machine.

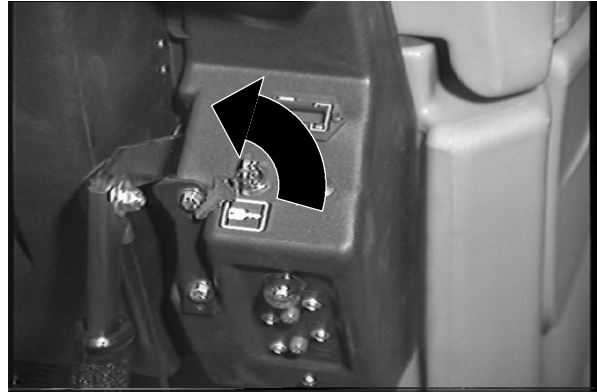

2. Set the parking brake, if your machine has this option.

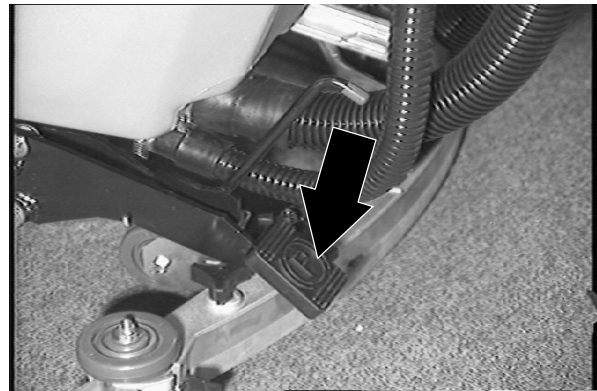

3. Remove the squeegee suction hose from the top of the squeegee.

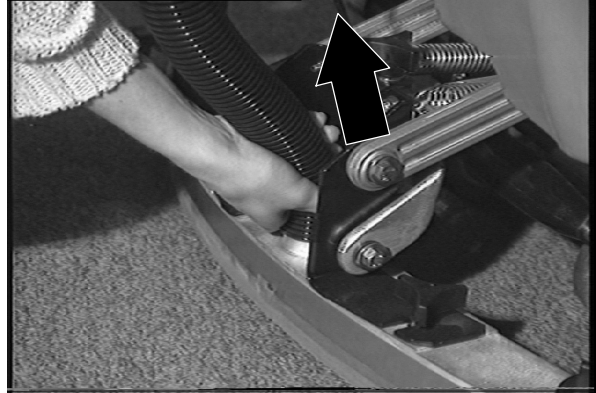

4. Put together the wand and the wand hose.

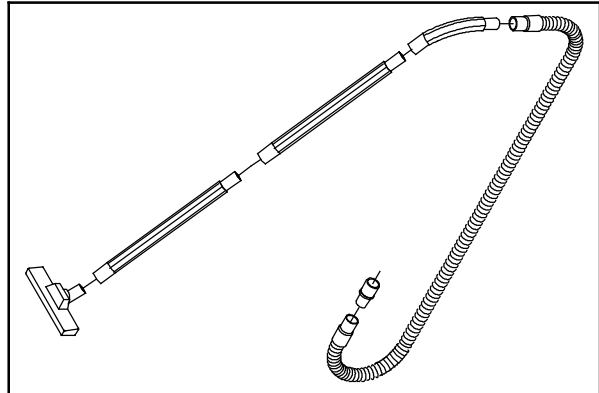

1008C

5. Connect the vacuum wand hose and the squeegee suction hose with the adapter.

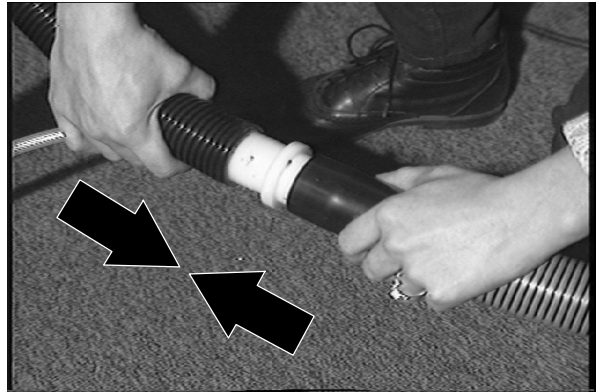

6. Turn the machine power on.

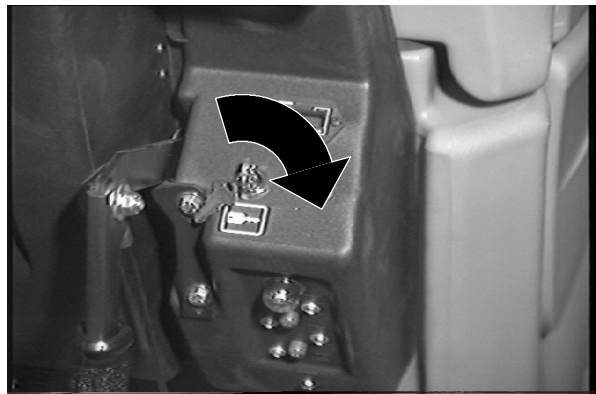

OPERATION

7. Lower the squeegee with the squeegee switch to turn the vacuum system on.

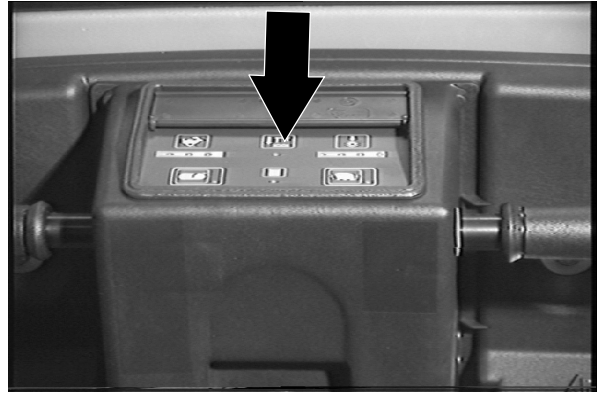

8. Vacuum the floor.

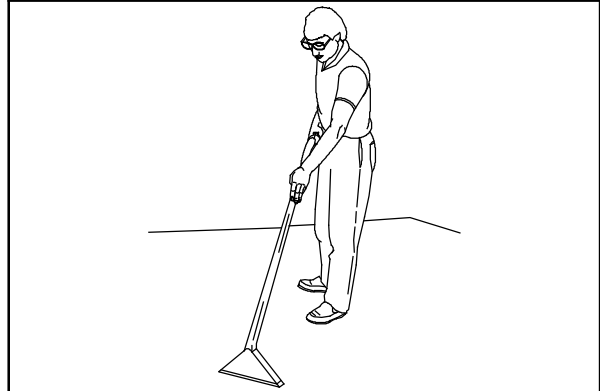

06596

9. When finished, raise the squeegee to shut off the vacuum.

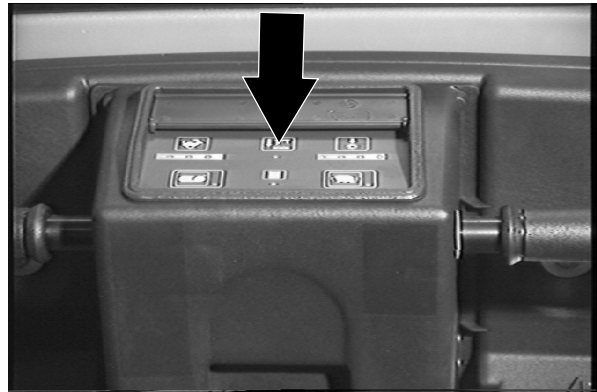

10. Turn the machine power off.

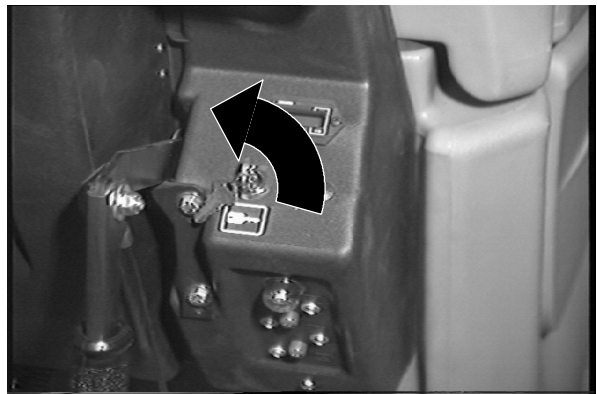

11. Remove the vacuum hose from the squeegee suction hose.

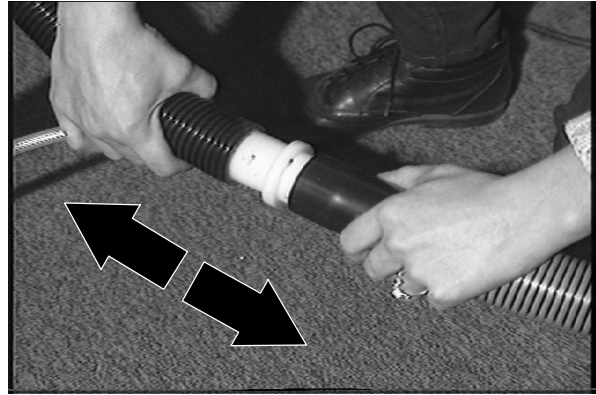

12. Reconnect the squeegee suction hose to the top of the squeegee.

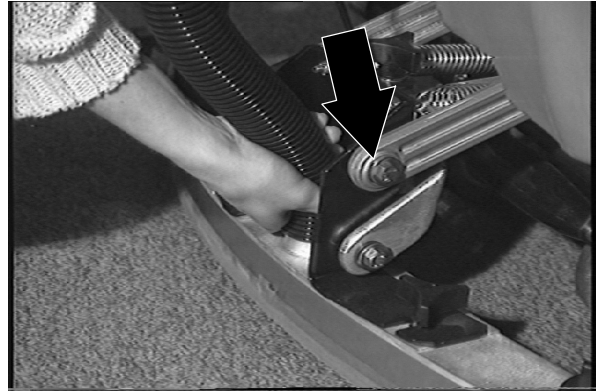

OPERATION

POWER WAND

The power wand uses the machine's vacuum and solution systems. The power wand allows scrubbing of floors that are out of reach of the machine.

 **WARNING: Flammable materials or reactive metals can cause an explosion or fire. Do not pickup.**

1. Turn the machine power off.

FOR SAFETY: Before leaving or servicing machine, stop on level surface, and turn off machine.

2. Set the parking brake, if your machine has this option.

3. Remove the squeegee suction hose from the top of the squeegee.

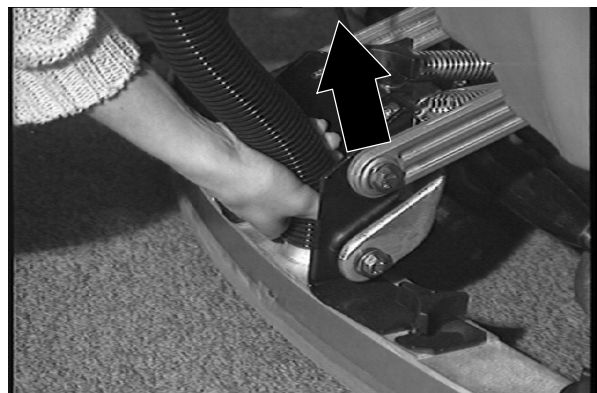
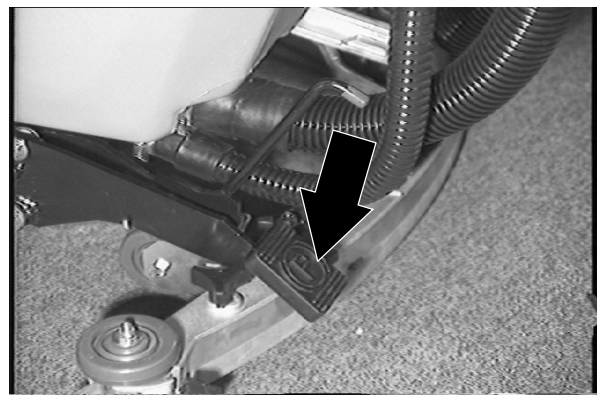
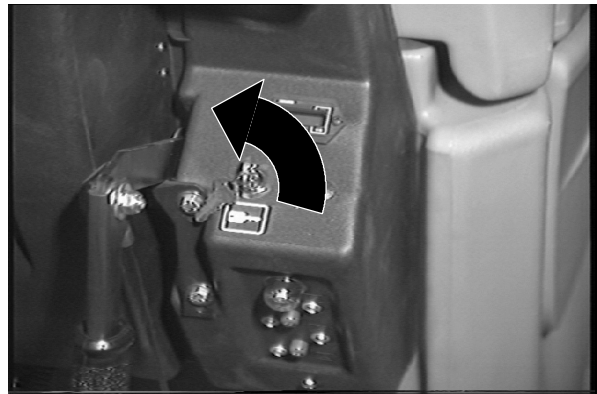

4. Connect the vacuum wand hose and the squeegee suction hose with the adapter.

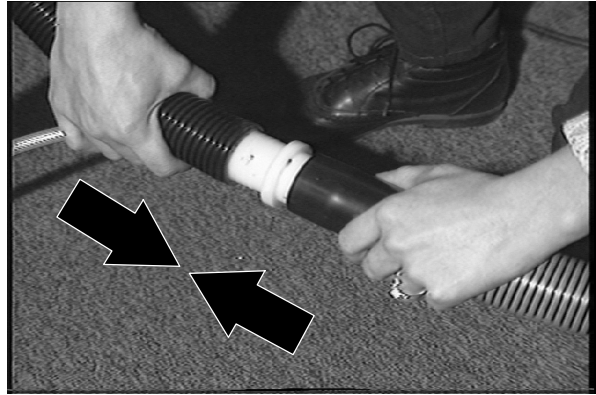

5. Open the solution tank cover. Attach the end of solution hose to the quick-disconnect. Push the connector in until it stops. Pull on the hose to make sure it is connected.

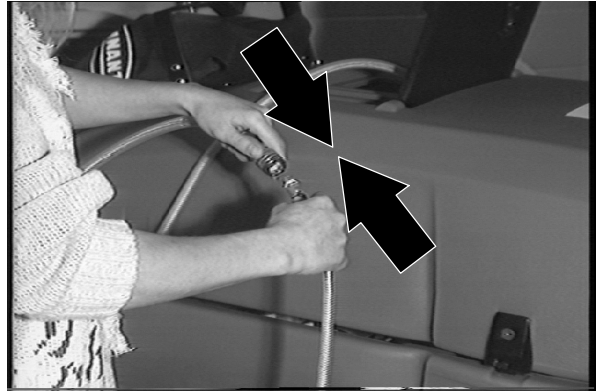

6. Attach the other ends of the solution and vacuum hoses to the power wand.

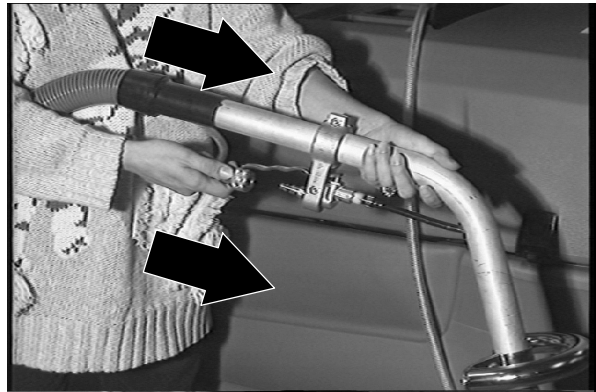

7. Turn the machine power on.

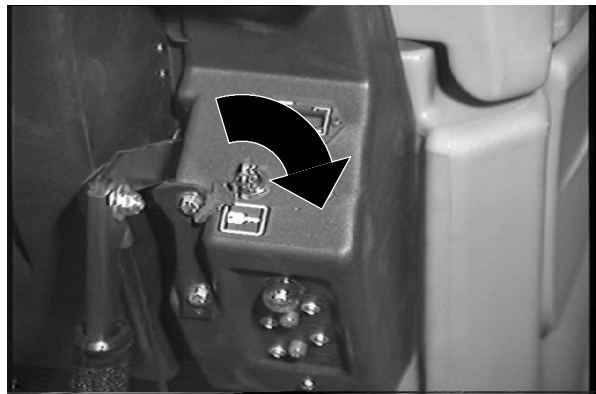

OPERATION

- Lower the squeegee with the squeegee switch to turn the vacuum system on.

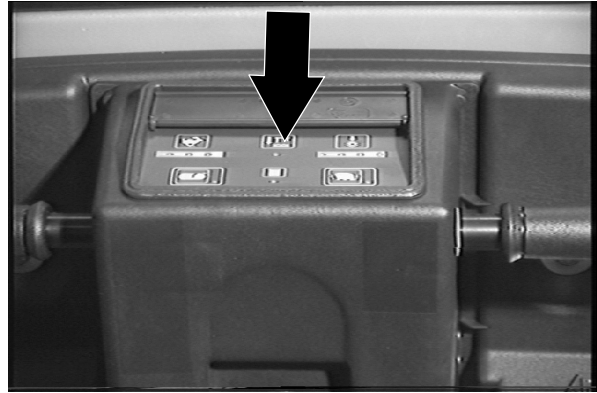

- Switch the power wand on.



- Squeeze the solution lever on the power wand to spray solution on the floor. Scrub the floor with the brush side of the cleaning tool.



- Vacuum up the solution by turning over the cleaning tool so the squeegee side is down.

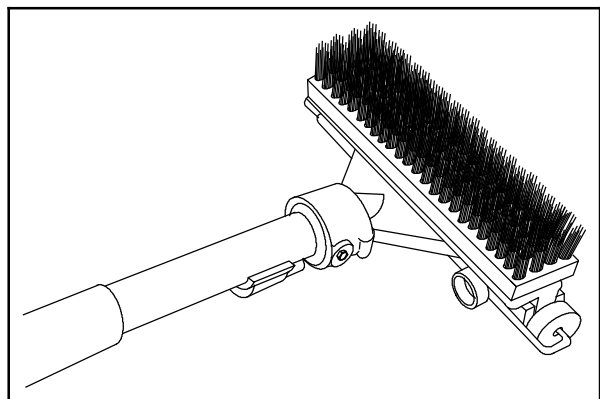

06202

If the cleaning tool is hard to push or is not picking up the solution very well, adjust the roller wheels on the tool by turning the black adjustment knob.

NOTE: The wheels are properly adjusted when the squeegee blades deflect slightly while the tool is pushed back and forth.

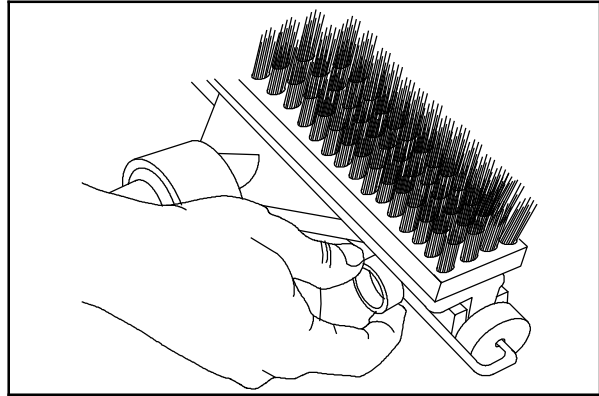

06604

12. When finished, switch the power wand off.



13. When finished, raise the squeegee to shut off the vacuum.

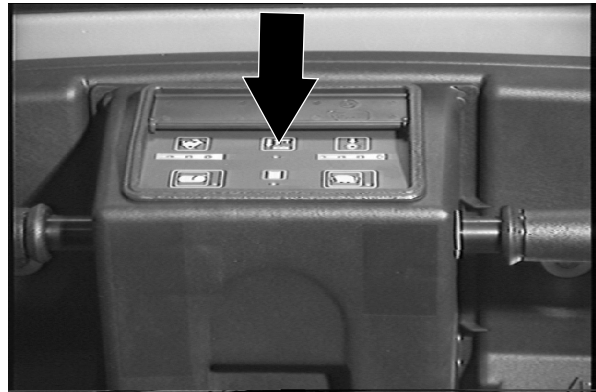

14. Disconnect the solution hose from the machine.

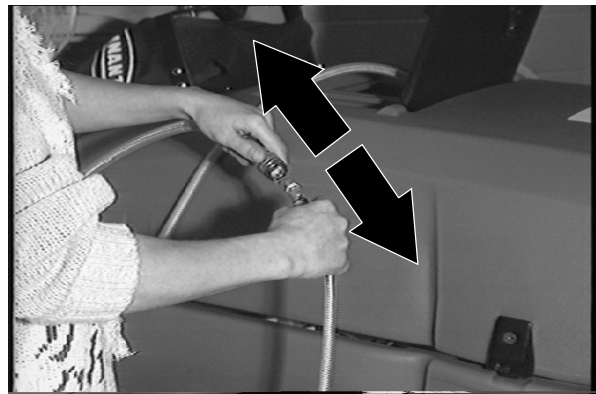

OPERATION

15. Remove the vacuum hose from the squeegee suction hose.

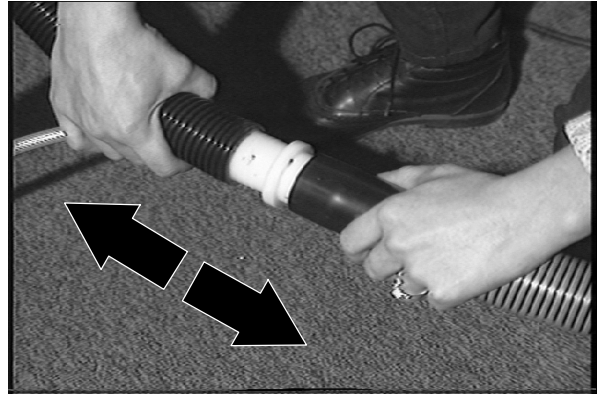

16. Disconnect the other ends of the solution and vacuum hoses from the power wand.

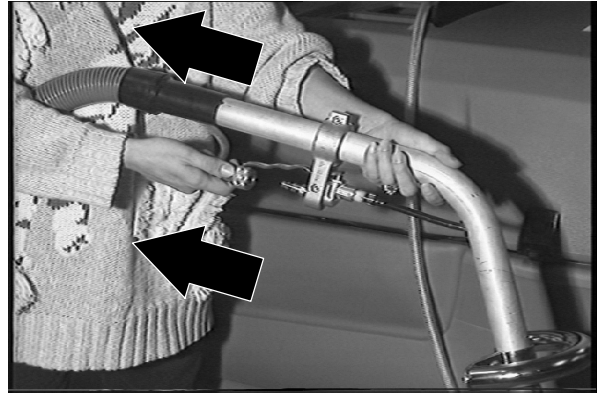

17. Turn the machine power off.

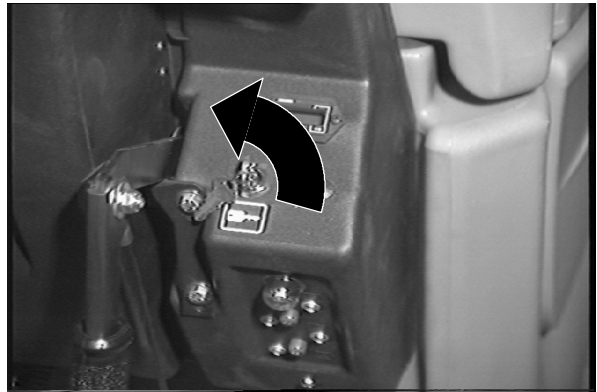

18. Reconnect the squeegee suction hose to the squeegee.

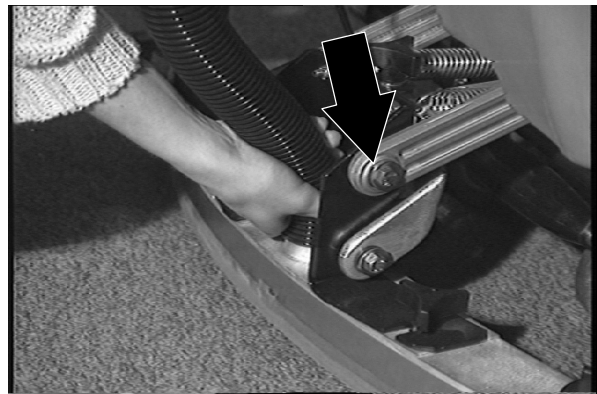

MAINTENANCE

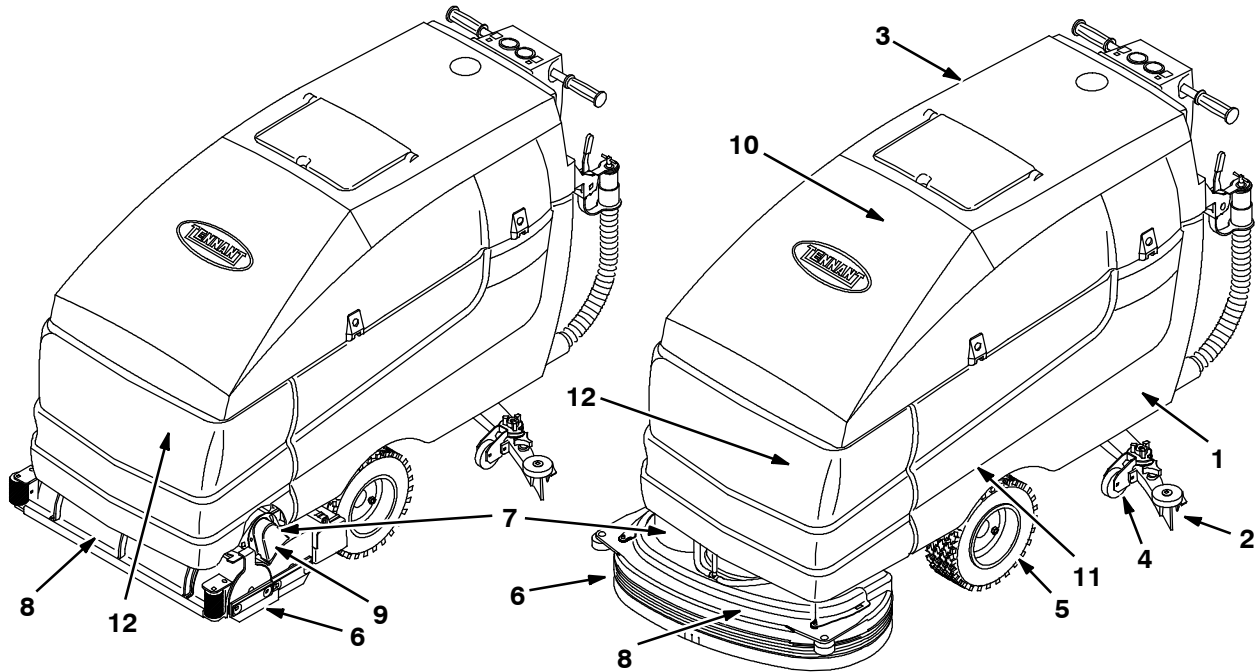

10066, 10190

MAINTENANCE CHART

Interval	Key	Description	Procedure	Lubricant/ Fluid	No. of Service Points
Daily	2	Squeegee	Check for damage and wear	-	1
			Check deflection and leveling	-	1
	8	Scrub brushes or pads	Check for damage and wear	-	2
	1	Recovery tank	Clean tank	-	1
			Clean level sensor	-	1(2)
			Clean vacuum fan filter	-	1
			Clean debris screen (option)	-	1
	1	Recovery tank, ES mode	Clean ES filter	-	1
	3	Solution tank, ES mode	Clean	-	1
	3	Vacuum fan filter	Clean	-	1
		Machine	Check for leaks	-	1
	6	Disk scrub head skirt	Check adjustment	-	1
			Check for damage and wear	-	1
6	Cylindrical scrub head skirts	Check adjustment	-	4	
		Check for damage and wear	-	4	
12	FaST PAK supply hose and connector (option)	Clean and connect hose to storing plug when not in use	-	1	
50 Hours	5	Front tires	Check air pressure	-	2
	8	Cylindrical brushes	Check taper and rotate front to rear	-	2
	12	FaST Filter screen (option)	Clean	-	1

MAINTENANCE

Interval	Key	Description	Procedure	Lubricant/ Fluid	No. of Service Points
100 Hours	4	Rear casters	Lubricate	SPL	2
	9	Cylindrical scrub brush drive belts	Check tension	-	2
500 Hours	10	Vacuum fan motor	Check motor brushes	-	1
1000 Hours	12	FaST water and air filters (option)	Replace	-	1
	7	Scrub brush motors	Check motor brushes	-	2
	11	Propelling motor	Check motor brushes	-	1
	11	Transaxle	Check lubricant level	GL	1

SPL - Special lubricant, Lubriplate EMB grease (TENNANT part no. 01433-1)

GL - SAE 90 weight gear lubricant

LUBRICATION

REAR CASTERS

The rear casters each have one grease fitting on the caster swivel. Lubricate the caster with a grease gun containing Lubriplate EMB grease (TENNANT part no. 01433- 1) every 100 hours of machine operation.

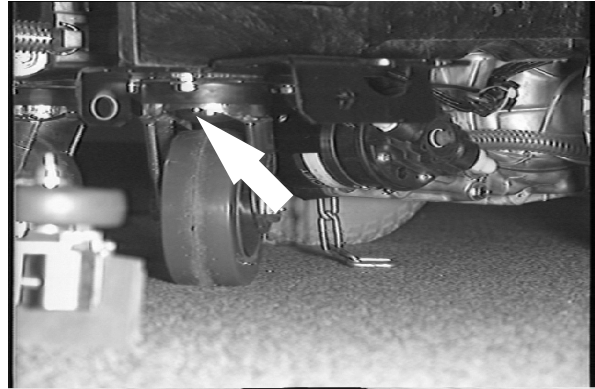

TRANSAXLE

Check the transaxle lubricant level every 1000 hours of operation by removing one of the orange filler plugs. If needed, add SAE 90 weight gear lubricant.

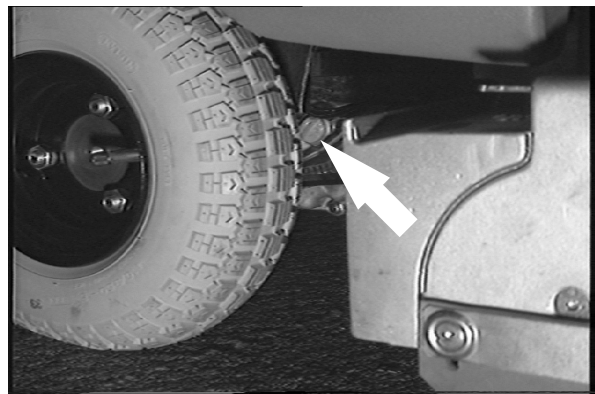

BATTERIES

FOR SAFETY: Before leaving or servicing machine, stop on level surface, turn off machine, and remove key.

The lifetime of the batteries depends on their proper maintenance. To get the most life from the batteries;

- Do not charge the batteries more than once a day and only after running the machine for a minimum of 15 minutes.
- Do not leave the batteries partially discharged for long period of time.
- Only charge the batteries in a well-ventilated area to prevent gas build up. Charge batteries in areas with ambient temperatures 27°C (80°F) or less.

MAINTENANCE

- Allow the charger to complete charging the batteries before re-using the machine.
- Maintain the proper electrolyte levels of flooded (wet) batteries by checking levels weekly.

CHECKING THE ELECTROLYTE LEVEL

The flooded (wet) lead-acid batteries require routine watering as described below. Check the battery electrolyte level weekly.

NOTE: ***Do Not** check the electrolyte level if the machine is equipped with a battery watering system.*

FOR SAFETY: When servicing machine, keep all metal objects off batteries. Avoid contact with battery acid.

The electrolyte level should be slightly above the battery plates as shown before charging. Add distilled water if low. **DO NOT OVERFILL.** The electrolyte will expand and may overflow when charging. After charging, distilled water can be added up to about 3 mm (0.12 in) below the sight tubes.

NOTE: *Make sure the battery caps are in place while charging. There may be a sulfur smell after charging batteries. This is normal.*

MAINTENANCE-FREE BATTERIES

Maintenance-free (Sealed AGM) batteries do not require watering. Cleaning and other routine maintenance is still required.

CHECKING CONNECTIONS / CLEANING

After every 200 hours of use check for loose battery connections and clean the surface of the batteries, including terminals and cable clamps, with a strong solution of baking soda and water. Replace any worn or damaged wires. Do not remove battery caps when cleaning batteries.

Objects made of metal can potentially short circuit the batteries. Keep all metallic objects off the batteries.

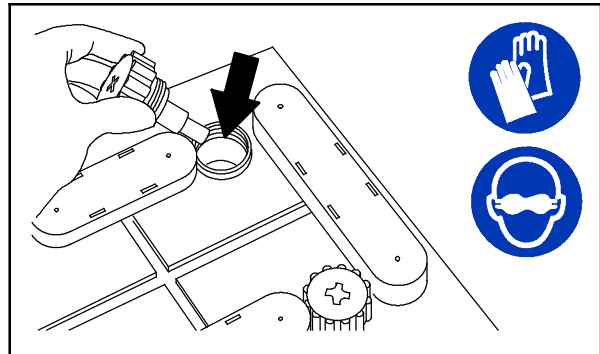

08247

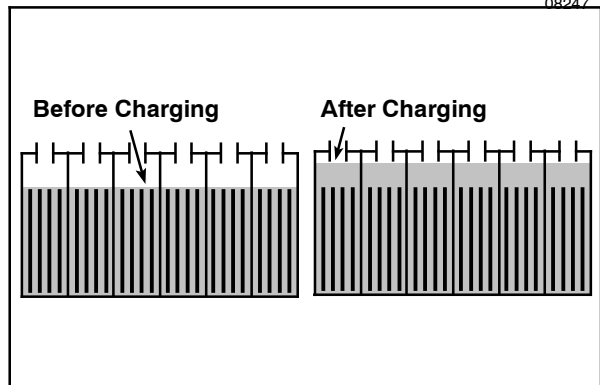

CHARGING THE BATTERIES

FOR SAFETY: When servicing machine, the use of incompatible battery chargers may damage battery packs and potentially cause a fire hazard. Inspect charger cord regularly for damage.

1. Drive the machine to a flat, dry surface in a well-ventilated area.
2. Turn the machine power off and set the parking brake if your machine has this option.

FOR SAFETY: Before leaving or servicing machine, stop on level surface, and turn off machine.

3. Lift up the solution tank to get access to the batteries.

NOTE: The solution tank must be empty.



NOTE: Make sure the batteries have the proper electrolyte level before charging. See CHECKING THE ELECTROLYTE LEVEL.

4. Plug the charger connector into the battery connector.

⚠ WARNING: Batteries emit hydrogen gas. Explosion or fire can result. Keep sparks and open flame away. Keep covers open when charging.

5. Plug the battery charger into the wall outlet.

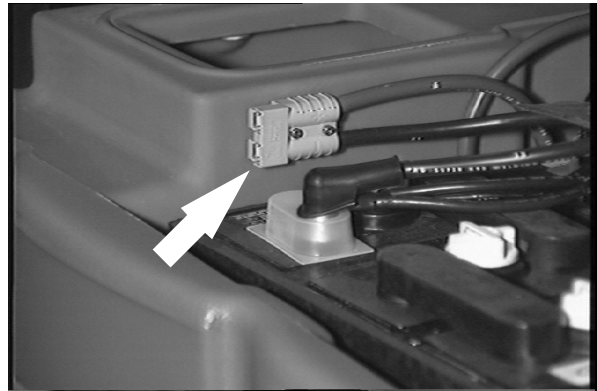

NOTE: Refer to the charger owner's manual for charger operating instructions.

MAINTENANCE

6. The charger will start automatically. When the batteries are fully charged, the charger will automatically turn off.
7. After the charger has turned off, unplug the charger from the wall outlet.
8. Unplug the charger connector from the battery connector on the machine.

FOR SAFETY: When maintaining or servicing machine, avoid contact with battery acid.

9. Lower the solution tank.
10. Pull up on the support arm and rotate the stop arm out of the way to allow the solution tank to close completely.

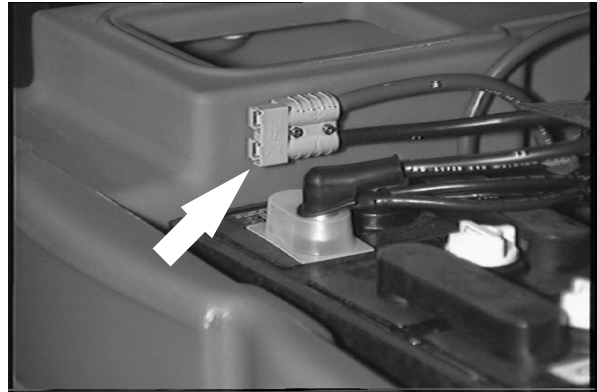

TOUCH PANEL

The touch panel can be used to run a self-diagnostic test of the machine electrical components and system.

1. Turn the machine power off.
2. While pressing the squeegee switch, turn the machine power on. Continue pressing the squeegee switch a few seconds, then release the switch.

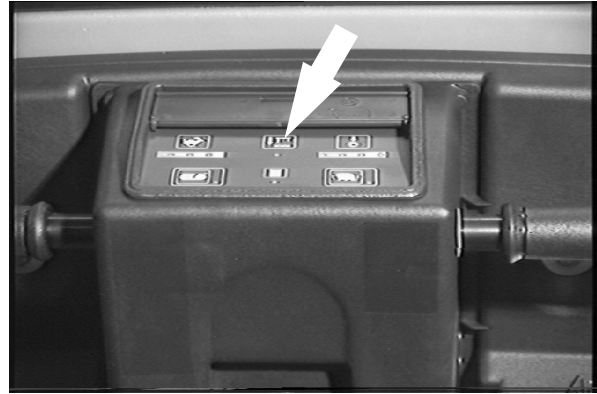

3. While the diagnostic is running, the three speed switch indicators will flash. The machine systems will activate as follows:
 - The brushes and squeegee raise.
 - The vacuum fan starts and the squeegee lowers. The squeegee raises and the vacuum fan shuts off.
 - The scrub head lowers and raises.
 - The brushes turn on and off.
 - The solution valve turns on and off.
 - The ES™ pump turns on and off, if the machine has the ES™ option.
 - The vacuum fan starts and shuts off.
 - The brushes turn on and off.

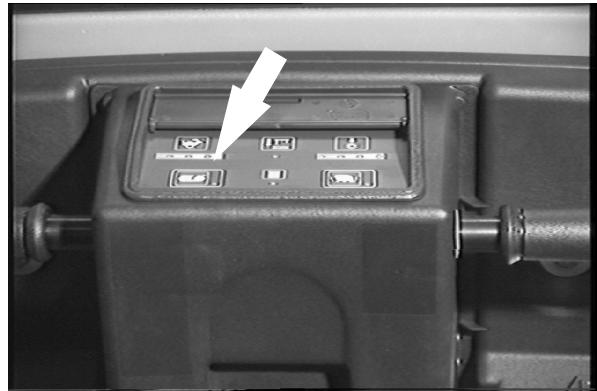

MAINTENANCE

If the self-diagnostic test finds an error in the system, the error will be displayed by the brush pressure switch indicators. Note which of the indicators are on, and contact the service personnel.

4. Turn off the diagnostic by turning off the machine power.

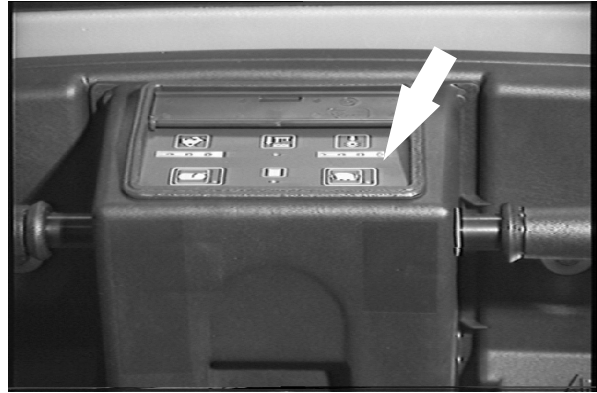

ELECTRIC MOTORS

The carbon brushes on the vacuum fan motor should be inspected after every 500 hours of machine operation. The carbon brushes on the scrub brush motors and propelling motor should be inspected after every 1000 hours of machine operation.

SCRUB HEAD

The machine can be equipped with either a disk brush, or cylindrical brush scrub head. Both scrub heads contain skirts to control over-spray from the scrub brushes.

DISK BRUSH SCRUB HEAD SKIRT

Make sure the scrub head skirt touches the floor all the way around when the scrub head is lowered. Check the skirt for damage or wear daily.

ADJUSTING THE SCRUB HEAD SKIRT

1. Lower the scrub head on a level floor.
2. Turn the machine power off.

FOR SAFETY: Before leaving or servicing machine, stop on level surface, and turn off machine.

3. Check to see if the scrub head skirt touches the floor all the way around the scrub head.



4. If the skirt needs to be adjusted, pull the strap end away from the skirt. Loosen the strap from the buckle, and move the skirt up or down to touch the floor.

NOTE: Replace the scrub head skirt when it is damaged or no longer is able to touch the floor.

5. Pull the strap tight through the buckle, and attach the strap end to the skirt using the hook and loop fastener.
6. Raise the scrub head.



MAINTENANCE

REPLACING THE SCRUB HEAD SKIRT

1. Lower the scrub head.
2. Turn the machine power off.

FOR SAFETY: Before leaving or servicing machine, stop on level surface, and turn off machine.

3. Pull the strap end away from the skirt.
Loosen and pull the strap from the buckle.



4. Pull the old skirt off the scrub head.
5. Put the new skirt on the scrub head, lining up the notches under the rollers.
6. Pull the strap tight through the buckle, and attach the strap end to the skirt using the hook and loop fastener.
7. Adjust the skirt as stated in *ADJUSTING THE SCRUB HEAD SKIRT*.

CYLINDRICAL BRUSH SCRUB HEAD SKIRTS

The four head skirts should just touch the floor. Check the skirts for damage or wear daily.

ADJUSTING THE SCRUB HEAD SKIRTS

1. Lower the scrub head on a level floor.
2. Turn the machine power off.

FOR SAFETY: Before leaving or servicing machine, stop on level surface, and turn off machine.

3. Check to see if the scrub head skirts touch the floor.
4. If any of the skirts needs adjusting, loosen the retainer strip hardware and slide the skirt to the proper adjustment. Tighten the retainer strip hardware.

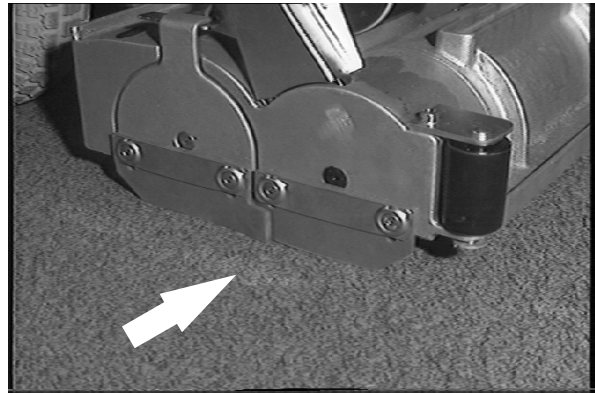

REPLACING THE SCRUB HEAD SKIRTS

1. Raise the scrub head.
2. Turn the machine power off.

FOR SAFETY: Before leaving or servicing machine, stop on level surface, and turn off machine.

3. Remove the retainer strip and hardware.
4. Replace the old skirt with a new skirt and mount in place with the retainer strip and hardware.

MAINTENANCE

REMOVING OR REPLACING THE SCRUB HEAD

The scrub heads are available in two brush types, and three widths. The scrub heads are interchangeable when the scrub brush motor circuit breakers, installed in the operator console, match the circuit breakers needed as shown in the following chart:

SCRUB HEAD/CIRCUIT BREAKERS

Scrub head	Disk	HD Disk	Cylindrical
Model 700 700 mm (28 in)	20 A	-	20 A
Model 800 800 mm (32 in)	20 A	35 A	20 A
Model 900 900 mm (36 in)	-	35 A	20 A

NOTE: To interchange the model 800 or the model 900 heavy duty disk head with one of the other available scrub heads, you must change the scrub brush motor circuit breakers in the operator console. Interchanging the scrub heads without changing the scrub brush motor circuit breakers will cause the scrub brush motors or circuit breakers to fail.

NOTE: When you change to a different width scrub head, be sure to install the appropriate width squeegee and machine front cover.

1. Lower the scrub head.
2. Turn the machine power off.

FOR SAFETY: Before leaving or servicing machine, stop on level surface, and turn off machine.

3. Remove the machine front cover.

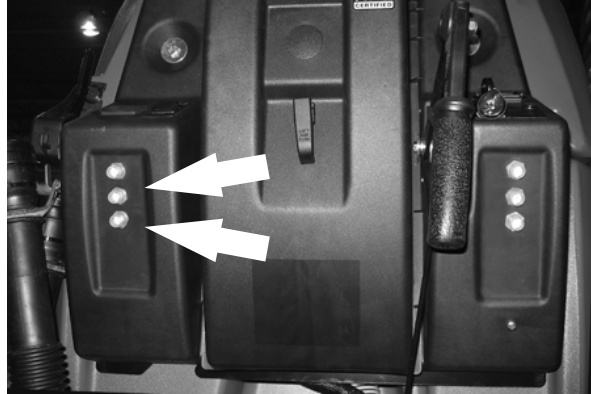

4. Disconnect the solution line from the scrub head tee fitting.

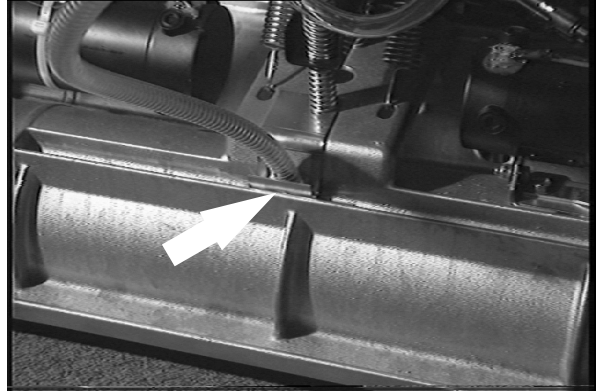

5. Disconnect the wire harness.

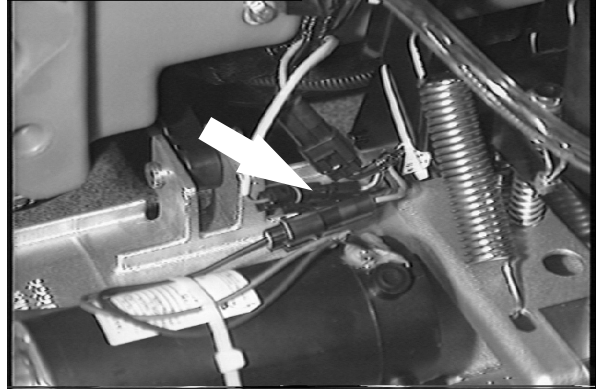

6. Disconnect the scrub head from the guide by removing the clevis pin.

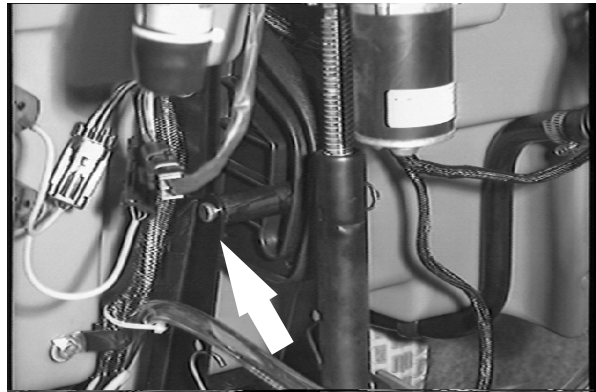

7. Disconnect the lift arms from the scrub head by removing the two clevis pins.

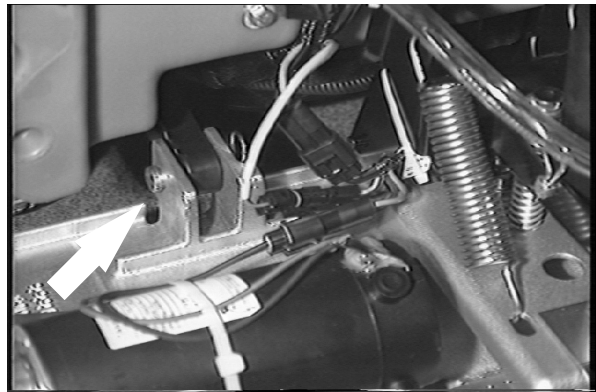

MAINTENANCE

8. Disconnect the actuator from the scrub head by removing the clevis pin.
9. To install the scrub head, connect the lift arms to the scrub head with the two clevis pins.
10. Connect the scrub head to the guide with the clevis pin.
11. Connect the actuator to the scrub head with the clevis pin.
12. Connect the wire harness.
13. Connect the solution line to the scrub head tee fitting.

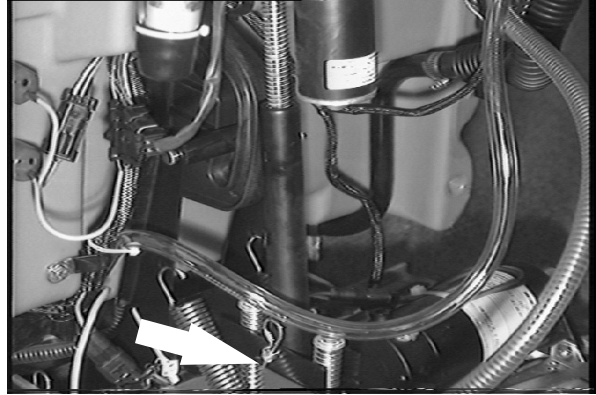

LEVELING THE SCRUB HEAD

NOTE: Check the tires for correct tire pressure before leveling the scrub head.

1. Make sure the scrub head is lowered to the floor.
2. Check the level of the scrub head by measuring the distance from the top of the scrub head, to the floor at all four corners. The scrub head should measure the same on all four corners.

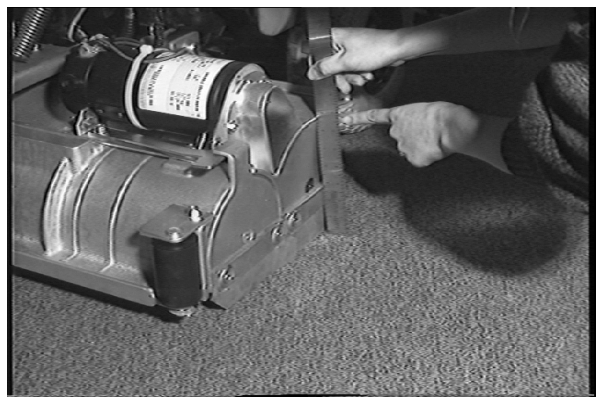

3. If the scrub head is not level at all four corners, loosen the jam nut on the adjustment screw located on the top of the scrub head. Turn the adjustment screw until the scrub head measures level. Tighten the jam nut.
4. Install the machine front cover.
5. Cylindrical scrub head: Check the brush pattern as described in *CHECKING AND ADJUSTING CYLINDRICAL BRUSH PATTERN*.

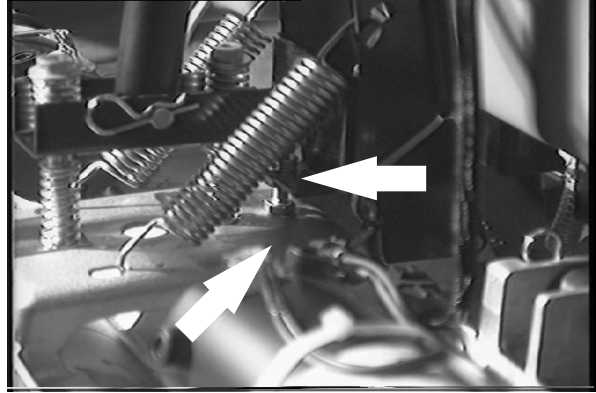

SCRUB BRUSHES

The scrub brushes should be checked daily for wire or string tangled around the brush or drive hub. The brushes should also be checked for any damage and wear.

DISK BRUSHES AND PADS

Replace the pads when they no longer clean effectively. Replace the brushes when they no longer clean effectively or when the bristles are worn to the yellow indicator.

Cleaning pads must be placed on pad drives before they are ready to use. The cleaning pad is held in place by a pad holder.

Cleaning pads need to be cleaned immediately after using with soap and water. Do not wash the pads with a pressure washer. Hang dry pads, or lie flat to dry.

NOTE: Be sure to replace brushes and pads in sets. Otherwise one brush or pad will be more aggressive than the other.

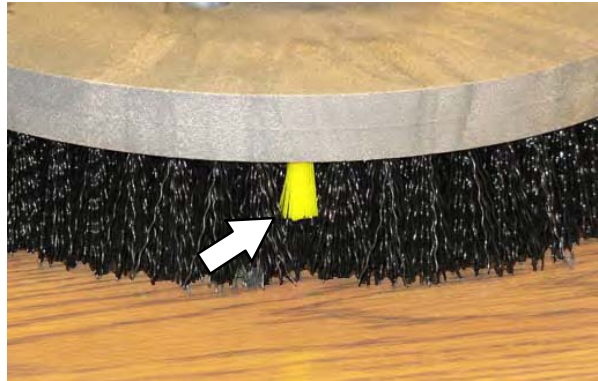

REPLACING THE DISK BRUSHES OR PADS

1. Raise the scrub head.
2. Turn the machine power off.

FOR SAFETY: Before leaving or servicing machine, stop on level surface, set parking brake (if so equipped), turn off machine, and remove key.

3. Open the access cover on either corner of the scrub head.



4. Turn the brush/pad driver until you can see the brush spring clip.



5. Press the spring clip together with your thumb and index finger. The brush/pad driver will drop off the drive hub.

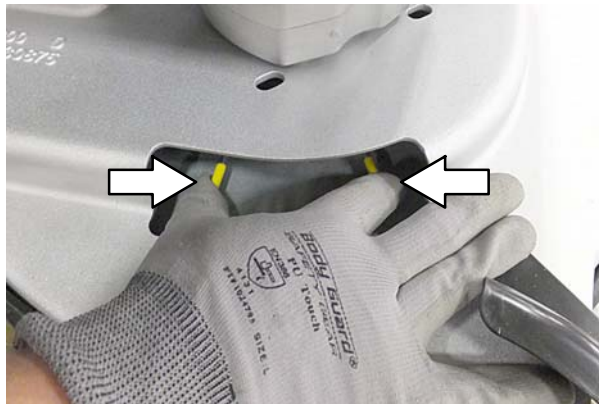

6. Pull the brush/pad driver out from under the scrub head.



7. **PAD DRIVER ONLY:** Press the spring clip together with your thumb and index finger to remove the center disk.



MAINTENANCE

8. Flip or replace the scrub pad, center the scrub pad on the pad driver. Replace the center disk to secure the pad in place on the driver.

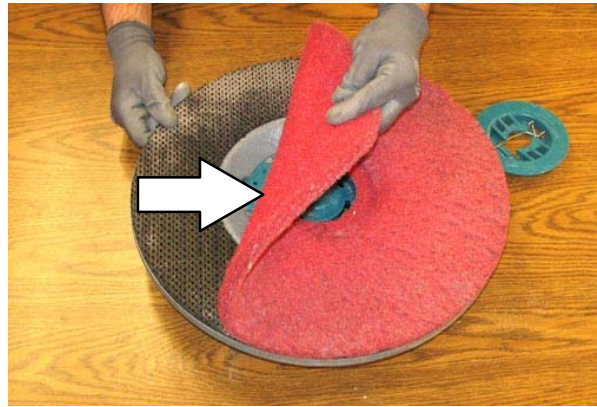

9. Set the yellow spring clip to the open position to make brush installation easier. Press spring clip together and downward to set.

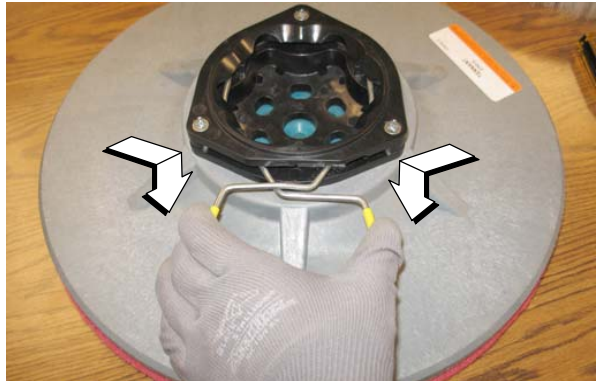

10. Align the pad driver or brush under the motor hub and push it upward to engage hub. Ensure that it is securely mounted onto the motor hub.
11. Close the scrub head access cover.
12. Repeat for the other brush/pad driver.



CYLINDRICAL BRUSHES

Check the brush taper and rotate the brushes from front-to-rear every 50 hours of operation, for maximum brush life and best scrubbing performance.

The cylinder brushes should be replaced if large amounts of bristles are missing, or if the remaining bristles' length is less than 10 mm (0.38 in).

NOTE: Be sure to replace brushes in sets. Otherwise one brush will be more aggressive than the other.

REPLACING THE CYLINDRICAL BRUSHES

1. Raise the scrub head.
2. Turn the machine power off and set the parking brake if your machine has this option.

FOR SAFETY: Before leaving or servicing machine, stop on level surface, and turn off machine.

3. Push down on the mounting spring and the idler door, then pull out on the bottom of the door. Push down on the spring until the door releases from the scrub head. Pull the idle plug off the brush.



4. Pull the brush out of the scrub head.
5. With the double row end of the brush towards you, guide the brush onto the drive hub.



NOTE: Use the double rows on the idler end of the brush.

MAINTENANCE

6. Insert the Idler plug of the idler door into the brush.

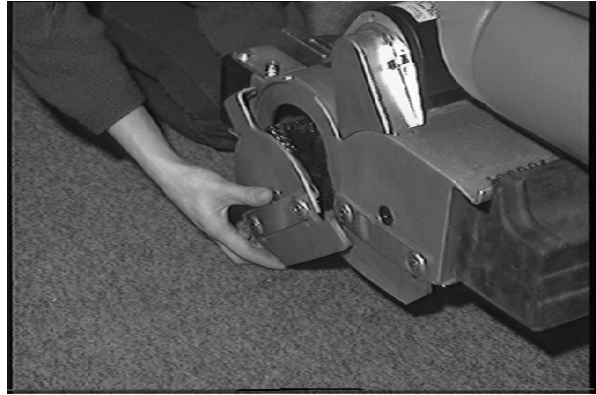

7. Push down on the door to catch the door in the scrub head, then pull up on the door to latch it in the spring.
8. Repeat for the other brush on the other side of the scrub head.

NOTE: The idler doors have stamped letters that correspond with letters on the scrub head. Make sure the idler doors are placed back on the same side of the scrub head that they were originally removed from.



CHECKING AND ADJUSTING CYLINDRICAL BRUSH PATTERN

NOTE: Check the tires for correct tire pressure and make sure the solution tank is full before checking or adjusting the brush pattern.

1. Apply chalk, or some other material that will not blow easily away, to a smooth, level floor.
2. Raise the scrub head. Position the scrub head over the chalked area.
3. Set the parking brake if your machine has this option.
4. Lower the scrub head for 15 to 20 seconds while keeping the scrub head in one spot in the chalked area.

NOTE: If chalk or other material is not available, allow the brushes to spin on the floor for two minutes. A polish mark will remain on the floor.

5. Raise the scrub head and move the machine away from the chalked area. Turn the machine power off.

6. Observe the shape of the brush patterns. If the brush patterns have parallel sides, the brushes do not need taper adjustment.

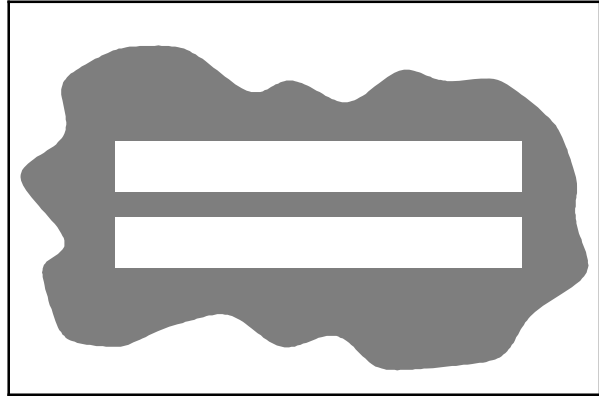

1035E

If one or both of the brush patterns are tapered, the brushes will have to be adjusted to straighten the brush pattern.

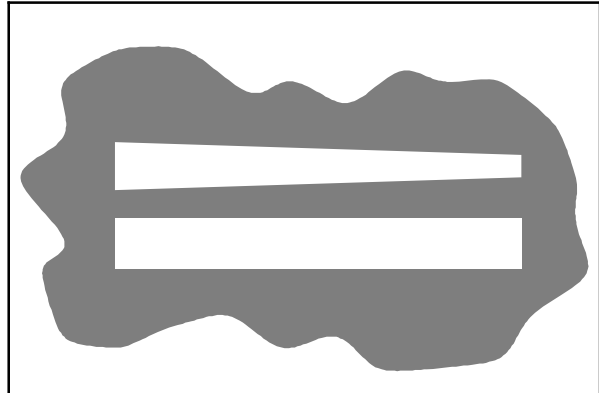

1035E

- A. Remove the idler door by pushing down on the mounting spring and the idler door, then pulling out on the bottom of the door. Push down on the spring until the door releases from the scrub head. Pull the idle plug off the brush.



- B. While holding the flat end of the idler shaft with a wrench, loosen the mounting screw on the outside of the idler door.



MAINTENANCE

- C. Turn the idler shaft to raise or lower the end of the brush as needed to straighten the brush pattern. Tighten the mounting screw.
- D. Check the brush patterns again and readjust as necessary.

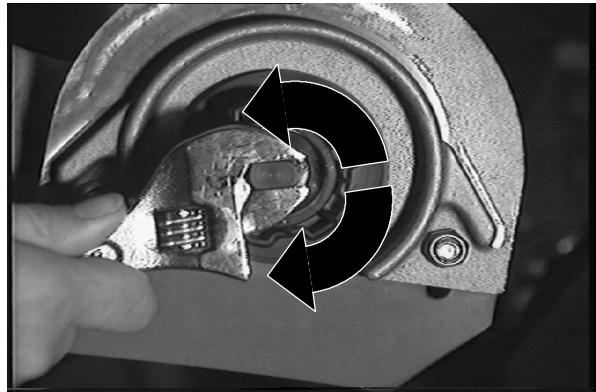

The brush patterns should be the same width. If one is narrower than the other, loosen the jam nut on the adjustment screw located on the top of the scrub head.

Turn the adjustment screw clockwise to increase the front brush pattern width. Turn the adjustment screw counter-clockwise to increase the back brush pattern width. Check the brush patterns again. Adjust until the front and back patterns are the same width.

Tighten the jam nut.

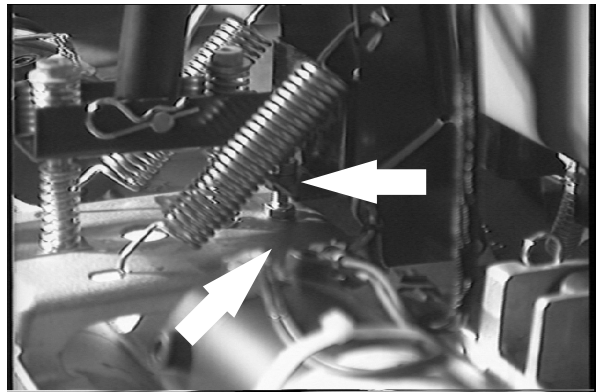

SOLUTION SYSTEM

RECOVERY TANK

The recovery tank stores recovered solution. The recovery tank should be drained and cleaned daily. The outside of the tank can be cleaned with vinyl cleaner.

Rinse and wipe off the level sensors daily. The level sensors are located inside the recovery tank.



ES option: The ES filter should be cleaned daily.

NOTE: Do not use steam to clean the tank.

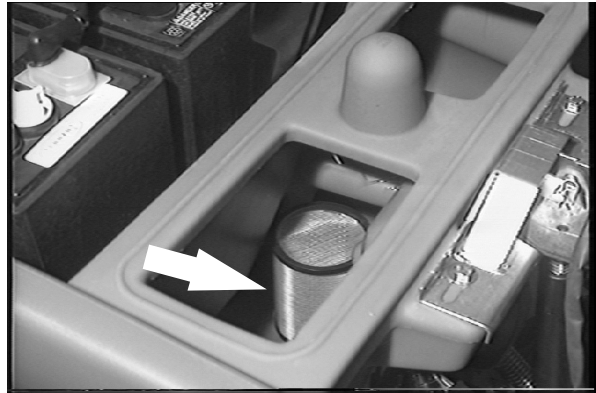

A vacuum fan filter is located in the recovery tank. Remove and clean this filter daily. Clean by shaking dust or rinsing pleats with low pressure water.

NOTE: Be sure the vacuum filter is dry before reinstalling it in the machine.



An optional debris screen is available for the recovery tank entry. If your machine is equipped with this screen, remove and clean it daily.



SOLUTION TANK

The solution tank stores the cleaning solution.

The solution tank does not require regular maintenance. If deposits form on the bottom of the tank, rinse the tank with a strong blast of warm water. The tank can be flushed through the fill opening and top access hole.

ES option: The solution tank should be drained and cleaned daily.

The solution tank contains one standard solution line filter, and one solution line filter for the power wand option. If the filters become dirty, the solution flow will be reduced. Check and clean these filters if necessary.

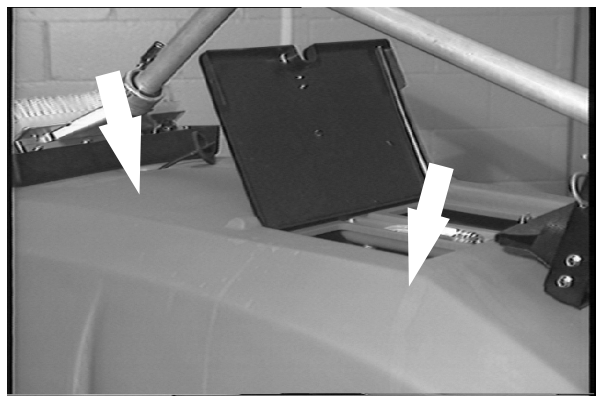

NOTE: Do not use steam to clean the tank.

MAINTENANCE

FaST SYSTEM (OPTION)

FaST SYSTEM MAINTENANCE

Every 1000 hours replace the water filter and air filter located in the FaST detergent injector. Order filter kit p/n 9003009.

To access the detergent injector assembly, lower the scrub head and remove the front cover.

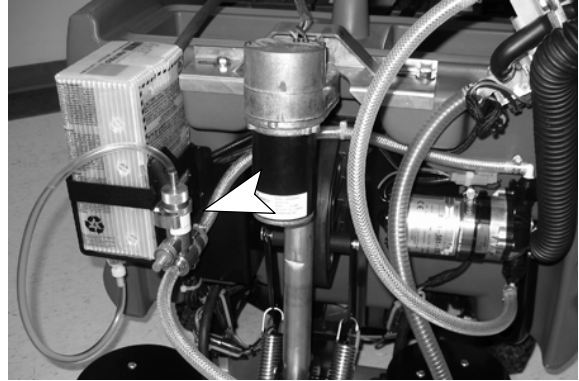

Remove the injector assembly from clamps.



Replace the water and air filter. An 8mm hex wrench required to install new water filter.

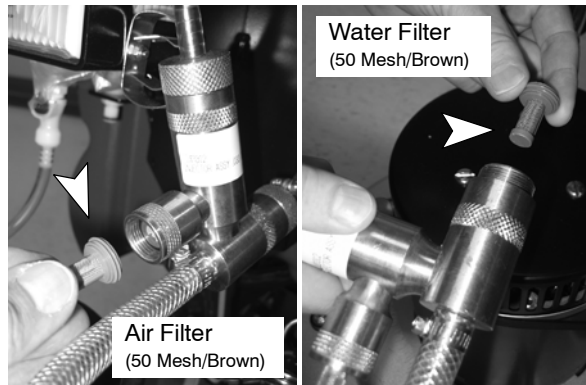

FaST SYSTEM FILTER SCREEN

The FaST system filter screen is located under the solution tank and filters the water from the solution tank as it flows into the FaST system.

Remove the filter screen bowl and clean the filter screen after every 50 hours of machine operation. Empty the solution tank before removing the filter.

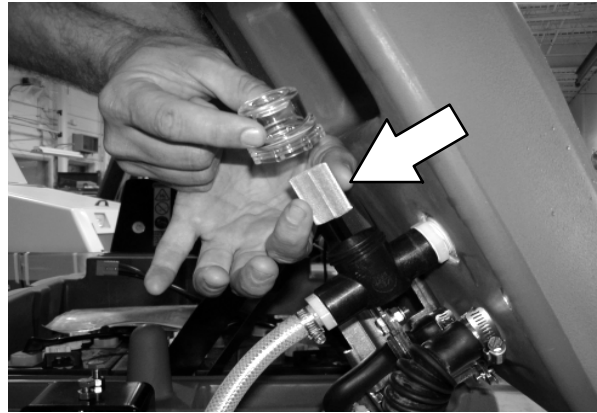
**FaST SUPPLY HOSE CONNECTOR**

The FaST supply hose connector is located below the FaST PAK holder. Soak the connector in warm water if detergent buildup is visible. When a FaST PAK carton is not installed, store the supply hose connector on the storing plug to prevent the hose from clogging.

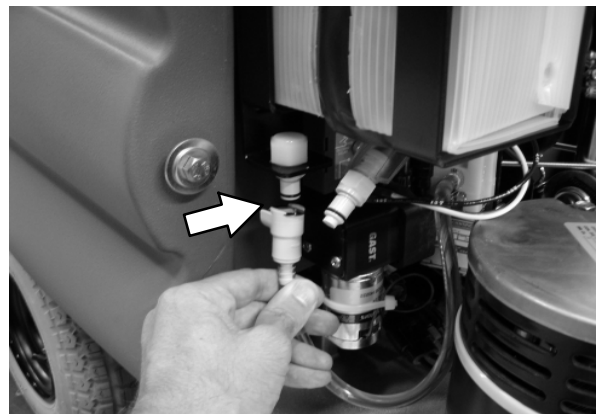

ec-H2O SYSTEM (OPTION)

ec-H2O NanoClean WATER CONDITIONING CARTRIDGE REPLACEMENT

(ec-H2O models labeled ec-H2O NanoClean)

FOR SAFETY: Before leaving or servicing machine, stop on level surface, set parking brake (if so equipped), and turn off machine.

The water conditioning cartridge is required to be replaced when it reaches its maximum water usage or expiration time of when the cartridge was activated, whichever comes first. The ec-H2O system indicator light will blink green/red when it's time to replace cartridge.

Depending on machine usage, on average, a new cartridge can last anywhere from 12 months for heavy machine usage to 24 months for light machine usage.

ATTENTION: During first time use and after replacing the water conditioning cartridge, the ec-H2O system will automatically override the selected solution flow rate for up to 75 minutes.

1. Lift the solution tank and remove the front cover from machine to access the cartridge. Drain solution tank before lifting.

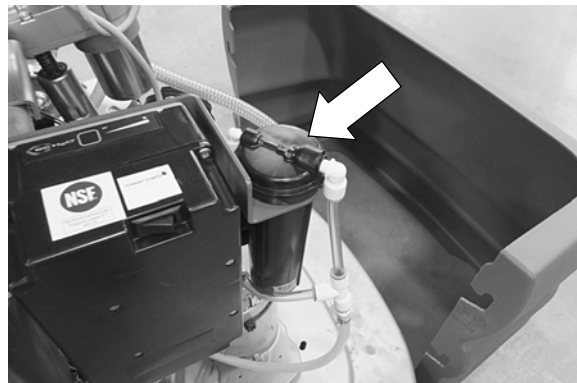

2. Disconnect the two hose connectors from cartridge by pressing the gray collars inward and pulling the connectors outward. Lift cartridge to remove.



3. Fill in the installation date on the new cartridge label.



4. Install the new cartridge and reconnect the two hoses. Make sure the hose connectors are fully inserted into new cartridge.
5. Reset timer for new cartridge.
Carefully read and understand all steps first before performing procedure.

A. Turn key on.

B. Press and hold the service switch, located on the ec-H₂O module, for 10 seconds. After releasing service switch, the three solution flow indicator lights will begin to (ripple) move back and forth.

C. Within 5 seconds after releasing the service switch, while the three indicator lights are moving back and forth, quickly press and release the solution flow button located on ec-H₂O module.

The three indicator lights will then blink three times to indicate timer has been reset.

Repeat process if the three indicator lights do not blink three times.

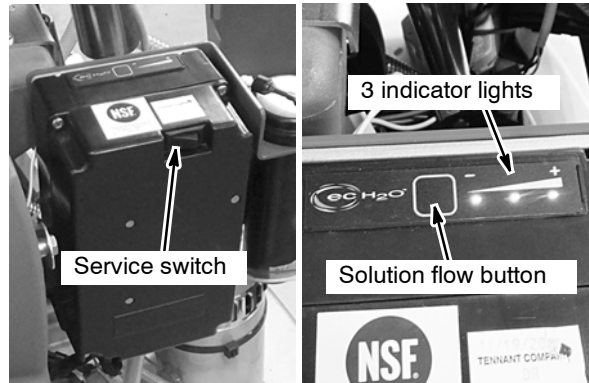

6. Reinstall the front cover.

ec-H2O MODULE FLUSH PROCEDURE

(ec-H2O models manufactured before ec-H2O NanoClean models)

This procedure is only required when an alarm sounds and the ec-H2O system indicator light begins to blink red.

1. Drain the solution tank and recovery tank of all water.
2. Pour 2 gallons (8 liters) of white or rice vinegar into the solution tank at full strength. Do not dilute.

NOTE: Use **white or rice vinegar** only. The acidity level should be between 4-8%. **Do not** use other acids for this procedure.

FOR SAFETY: When servicing machine, wear protective gloves and eye protection when handling vinegar.

3. Disconnect the black connector fitting at the scrub head and place the hose into a bucket. To access the connector fitting, you may have to remove the front cover from the machine.
4. Turn the key to the on (I) position.

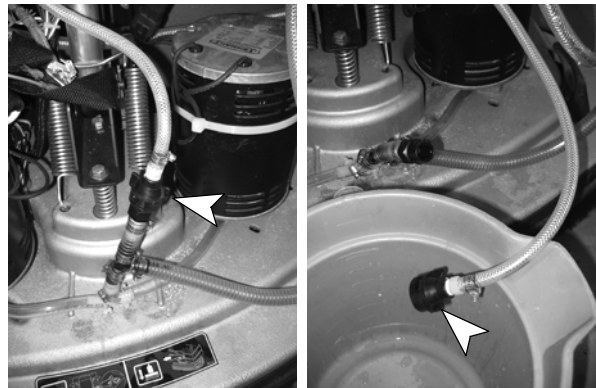

5. Press and release the ec-H2O module flush switch to start the flush cycle. The module is located behind the front cover.

NOTE: The module will automatically shut off when the flush cycle is complete (approx. 7 minutes). The module must run the full 7 minute cycle in order to reset the system indicator light and alarm.

Repeat flush procedure if the ec-H2O module does not reset. If module fails to reset, contact an Authorized Service Center.

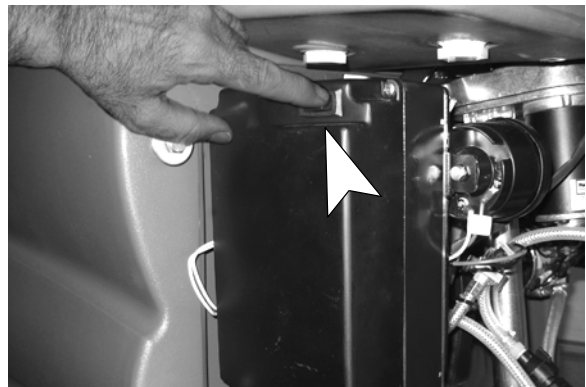

SQUEEGEE

The squeegee assembly channels water into the vacuum fan suction. The front blade channels the water, and the rear blade wipes the floor.

Check the squeegee blades for damage and wear daily. Rotate or replace either of the squeegee blades if the leading edge is torn or worn half-way through the thickness of the blade.

The squeegee can be adjusted for leveling and deflection. The deflection and leveling of the squeegee blades should be checked daily, or when scrubbing a different type of floor.

The squeegee assembly can be removed from the squeegee pivot to prevent damage during transport of the machine, or when changing to a different squeegee width. The squeegees are available in three widths to be used with the three different model scrub heads; model 700 (700 mm (28 in)), model 800 (800 mm (32 in)), and model 900 (900 mm (36 in)).

REMOVING THE SQUEEGEE ASSEMBLY

6. Raise the squeegee.
7. Turn the machine power off and set the parking brake if your machine has this option.

FOR SAFETY: Before leaving or servicing machine, stop on level surface, and turn off machine.

8. Remove the squeegee suction hose from the squeegee.



MAINTENANCE

9. Loosen the two mounting knobs.
10. Pull the squeegee off the machine.

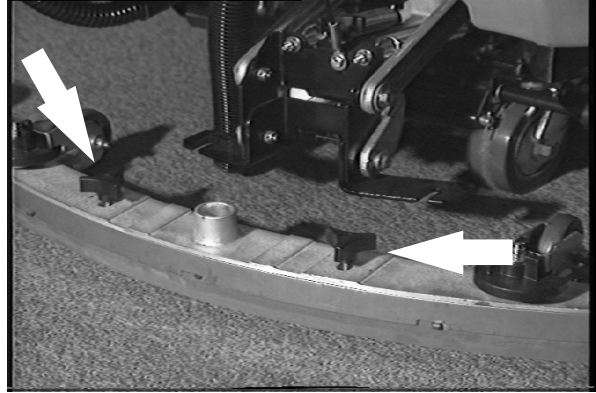

INSTALLING THE SQUEEGEE ASSEMBLY

1. Make sure the squeegee is raised.
2. Place the squeegee under the squeegee pivot.
3. Slide the squeegee frame onto the squeegee pivot.
4. Tighten the mounting knobs.
5. Push the squeegee suction hose on the squeegee.

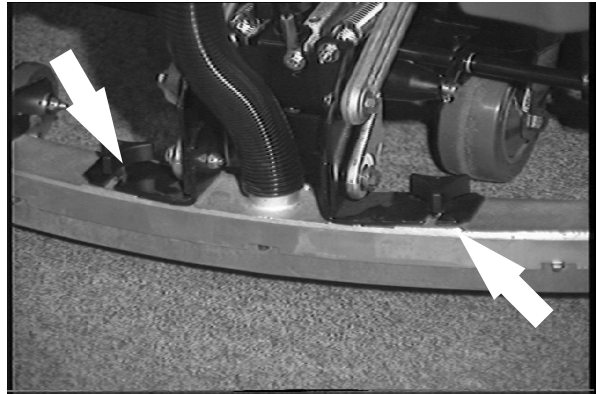

LEVELING THE SQUEEGEE

Leveling of the squeegee assures even contact the length of the squeegee blade with the surface being scrubbed. Make sure this adjustment is done on an even, level floor.

1. Turn the machine power on.
2. Lower the squeegee.
3. Drive the machine forward, then turn the machine power off.
4. Look at the deflection of the squeegee blade, over the full length of the squeegee blade.

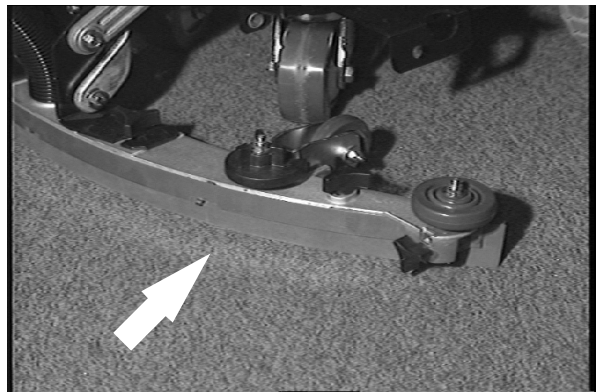

5. If the deflection is not the same over the full length of the blade, turn the squeegee leveling knob counter-clockwise to increase the deflection at the ends of the squeegee.

Turn the squeegee leveling knob clockwise to decrease the deflection at the ends of the squeegee blade.

6. Drive the machine forward again with the squeegee down to check the squeegee blade deflection.
7. Readjust the squeegee blade deflection if necessary.

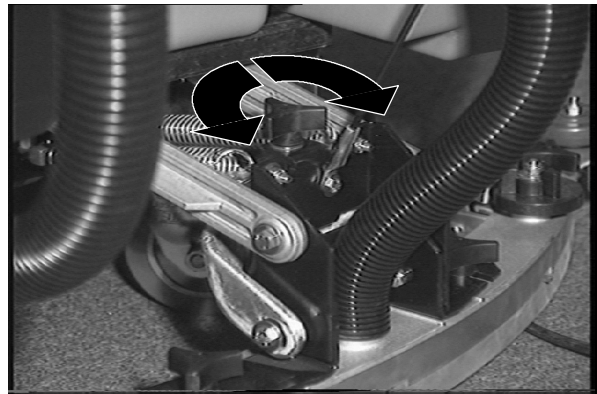

ADJUSTING SQUEEGEE BLADE DEFLECTION

Deflection is the amount of curl the squeegee blade has when the machine moves forward with the squeegee lowered to the floor. The best deflection is when the squeegee wipes the floor just dry with a minimum amount of deflection.

1. Turn the machine power on.
2. Lower the squeegee.
3. Drive the machine forward, and look at the deflection of the squeegee blade. The correct amount of deflection is 12 mm (0.50 in) for scrubbing smooth floors and 15 mm (0.62 in) for rough floors.

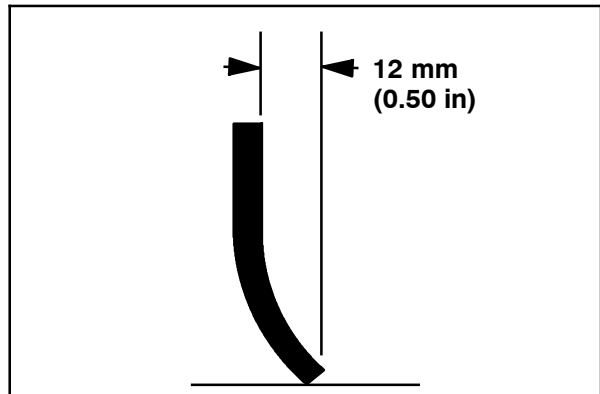

03716

4. Turn the machine power off.
5. To adjust the amount of deflection, turn the squeegee deflection cams counter-clockwise to decrease the blade deflection.

Turn the squeegee deflection cams clockwise to increase blade deflection.

6. Drive the machine forward again to check the squeegee blade deflection.
7. Readjust the squeegee blade deflection if necessary.

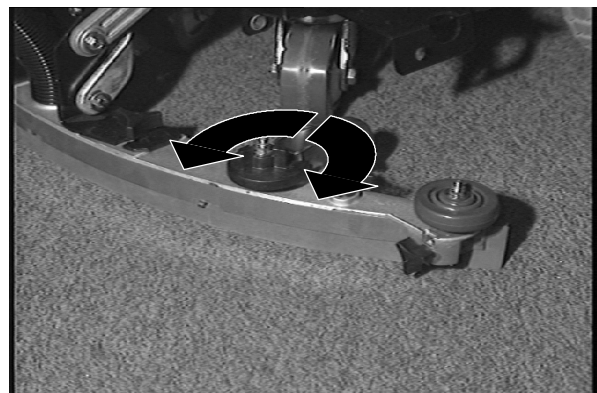

MAINTENANCE

ADJUSTING THE SQUEEGEE GUIDE ROLLERS

At each end of the squeegee are guide rollers to guide the squeegee blade end along a wall. Loosen the nut at the top of the guide roller and move the roller in or out to adjust how close the end of the squeegee blade comes to the wall. The squeegee blade end should be further away from the wall when the floor curves up into the wall.

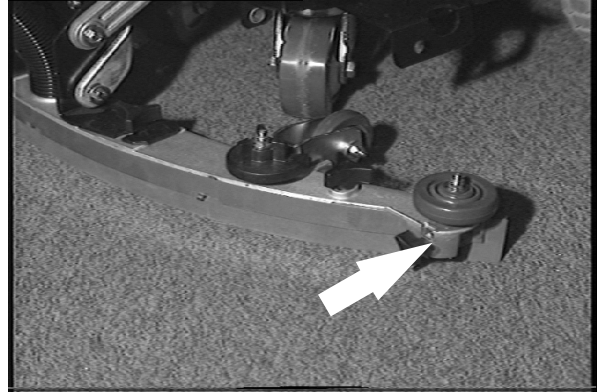

SQUEEGEE BLADES

The squeegee has two squeegee blades, the front and back. Each blade has four wiping edges. To use them all, start with one wiping edge. To use the next wiping edge, rotate the blade end-for-end. To use the next wiping edge, rotate the top edges down, bottom edges up. To use the last edge, rotate the blade end-for-end.

Replace any worn or damaged squeegee blades.

REPLACING OR ROTATING THE REAR SQUEEGEE BLADE

1. Make sure the squeegee is raised off the floor.
2. Turn the machine power off and set the parking brake if your machine has this option.

FOR SAFETY: Before leaving or servicing machine, stop on level surface, and turn off machine.

3. Loosen the two retention knobs, one at each end on the squeegee.

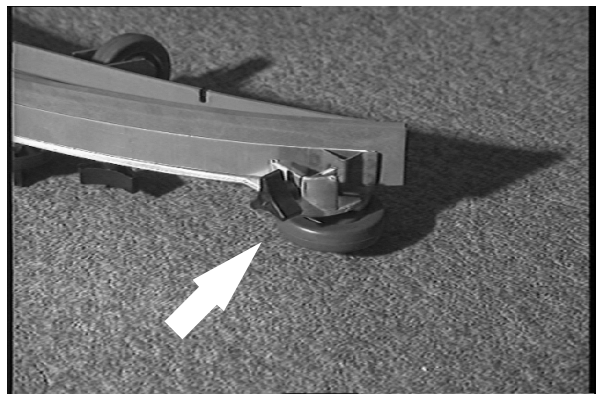

4. Pull off the rear retaining band.



5. Pull off the rear squeegee blade.
6. Insert the rotated or new squeegee blade and then insert the retainer band.
7. Tighten the two retention knobs until the ends of the front and rear squeegee blades touch. Do not overtighten.

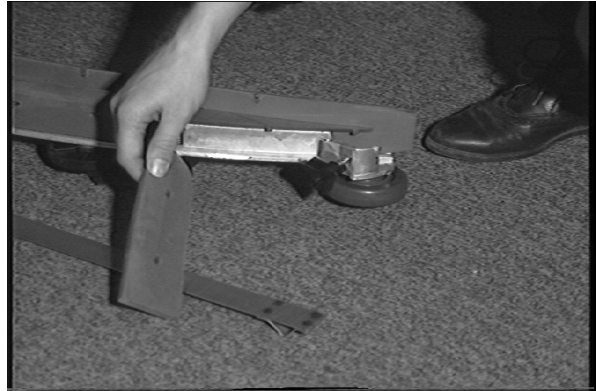

REPLACING OR ROTATING THE FRONT SQUEEGEE BLADE

1. Make sure the squeegee is raised off the floor.
2. Turn the machine power off and set the parking brake if your machine has this option.

FOR SAFETY: Before leaving or servicing machine, stop on level surface, and turn off machine.

3. Remove the squeegee from the machine. See *REMOVING THE SQUEEGEE ASSEMBLY*.
4. Remove the rear squeegee blade and retainer. See *REPLACING OR ROTATING THE REAR SQUEEGEE BLADE*.

MAINTENANCE

5. Loosen the two remaining knobs on top of the squeegee assembly.
6. Pull the retainer plate back and pull out the front squeegee blade of the squeegee frame.
7. Insert the rotated or new squeegee blade in the squeegee frame, lining up the slots in the blade with the tabs on the retainer plate.

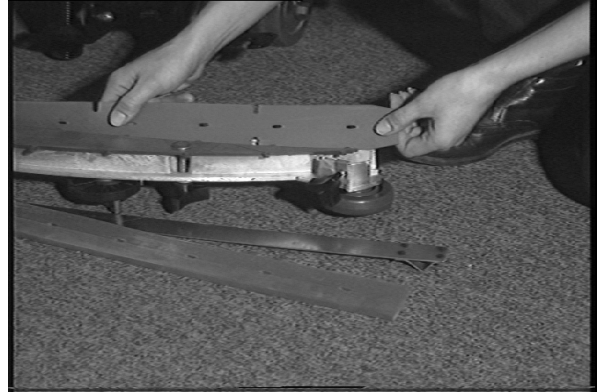

8. Push the retainer plate forward. Tighten the two outside knobs on top of the squeegee assembly.
9. Insert the rear squeegee blade and retainer. Tighten the two rear blade retention knobs until the ends of the front and rear squeegee blades touch. Do not overtighten.
10. Install the squeegee assembly on the squeegee pivot. See *INSTALLING THE SQUEEGEE ASSEMBLY*.
11. Adjust the squeegee blade leveling and deflection as stated in *LEVELING THE SQUEEGEE* and *ADJUSTING SQUEEGEE BLADE DEFLECTION*.



BELTS AND CHAINS

BRUSH DRIVE BELT

The two brush drive belts are located on the cylindrical brush scrub head. The belts drive the cylindrical brushes. Proper **new** belt tension is a 3 mm (0.1 in) deflection from a force of 1.37 to 1.48 kg (3.0 to 3.26 lb) at the belt midpoint.

When reusing an old belt, measure and record the belt tension before removal, so that the belt can be reinstalled at the same tension.

If the old belt tension was not recorded, the recommended force per old belts is 1.03 to 1.14 kg (2.28 to 2.52 lb) with a deflection of 3 mm (0.1 in).

Check the belt tension and wear every 100 hours of operation.

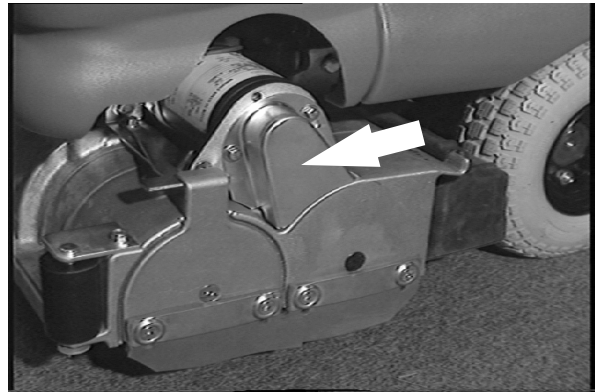

STATIC DRAG CHAIN

A static drag chain prevents the buildup of static electricity in the machine. The chain is attached to the transaxle.

Make sure the chain is always touching the floor.

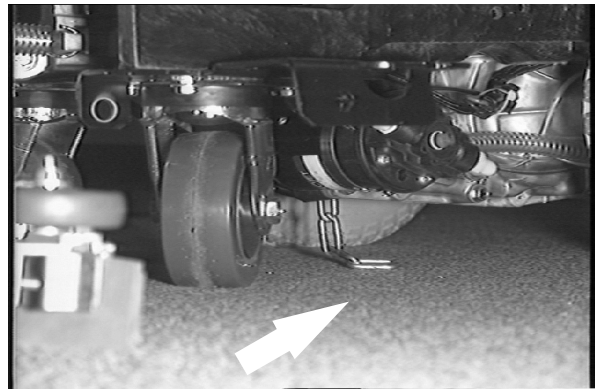

TIRES

The standard front tires are pneumatic.

Check the front tire pressure every 50 hours of operation. The proper tire air pressure is 415 to 450 kPa (60 to 65 psi).

The front wheel lug nuts should be tightened to 102 to 115 Nm (75 to 85 ft lb).

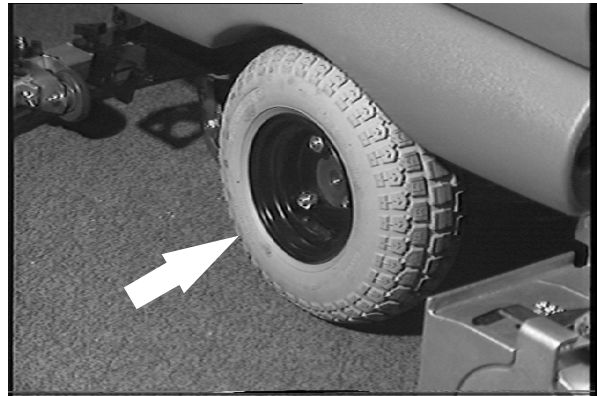

PUSHING AND TRANSPORTING THE MACHINE

PUSHING THE MACHINE

If the machine becomes disabled, it can be pushed as described below.

Models manufactured after serial number 10731451 are equipped with a transaxle that has an electric parking brake system. To disengage the parking brake system, position the brake lever on the transaxle in the down position. After pushing machine, make sure to raise the brake lever to the up position to prevent a roll hazard.

NOTE: The power to the machine is disabled when brake lever is in the down position.

Models manufactured before serial number 10731452 perform the following procedure.

Unplug the drive motor from the electrical harness before attempting to push a disabled machine. The machine will become easier to maneuver when it is unplugged.

ATTENTION! Do not push the machine for a long distance and without unplugging the drive motor or damage may occur to the propelling system.

Only push a disabled machine for a *very short distance* and do not exceed 3.2 kp/h (2 mph). It is NOT intended to be pushed for a long distance or at a high speed.

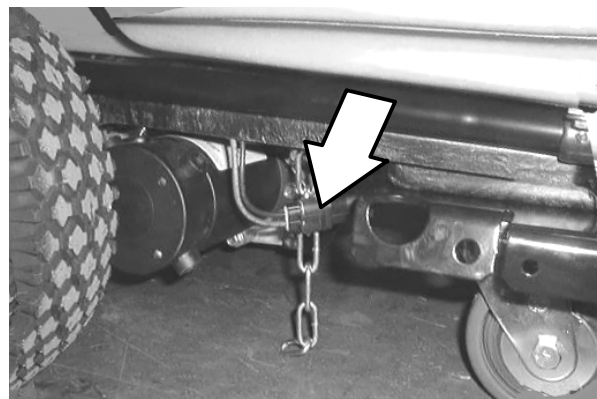
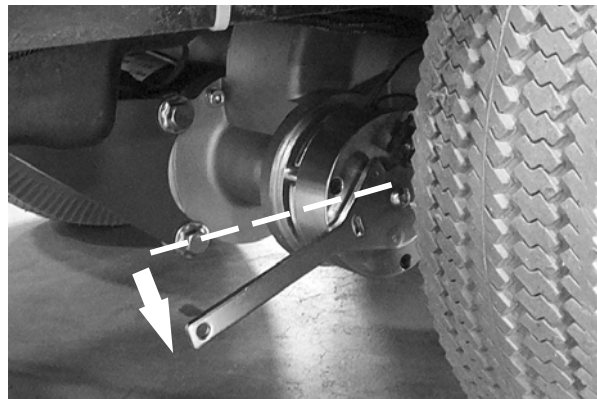

TRANSPORTING THE MACHINE

1. Position the rear of the machine at the loading edge of the truck or trailer.

FOR SAFETY: Use truck or trailer that will support the weight of the machine.

NOTE: Empty the recovery and solution tanks before transporting the machine.

2. If the loading surface is not horizontal or is higher than 380 mm (15 in) from the ground, use a winch to load machine.

If the loading surface is horizontal AND is 380 mm (15 in) or less from the ground, the machine may be pushed onto the truck or trailer.

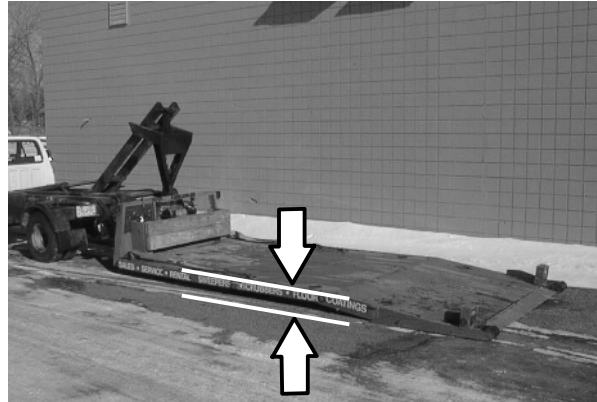

3. To winch the machine onto the truck or trailer, attach the winching chains to the rear tie down locations on either side of the machine frame by the rear casters.

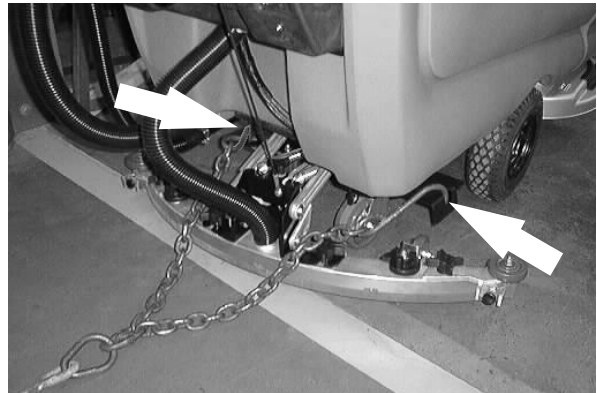

4. Unplug the drive motor from the electrical harness before attempting to winch the machine. The machine will become easier to maneuver when it is unplugged.

FOR SAFETY: When loading machine onto truck or trailer, use winch. Do not push the machine onto the truck or trailer unless the loading surface is horizontal AND is 380 mm (15 in) or less from the ground.

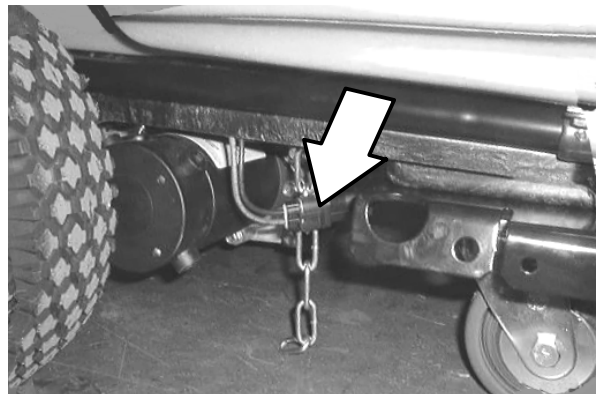

5. Position the machine onto the truck or trailer as far as possible. If the machine starts to veer off the centerline of the truck or trailer, stop and straighten the machine.

MAINTENANCE

6. Lower the scrub head with the brushes installed, lower the squeegee, and set the machine parking brake, if equipped when transporting the machine. Block the machine tires and tie down the machine to the truck or trailer before transporting.

NOTE: *Do not use the steering handles to secure the machine for transport.*

Secure a strap over the top of the machine to prevent the machine from tipping.



The rear tie-down locations are on either side of the machine frame by the rear casters.

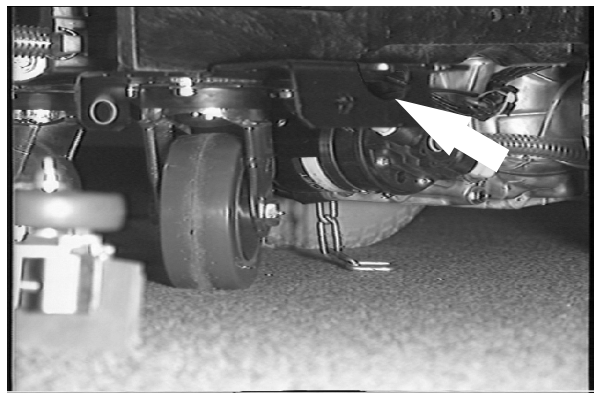

7. If the loading surface is not horizontal or is higher than 380 mm (15 in) from the ground, use a winch to unload machine.

If the loading surface is horizontal AND is 380 mm (15 in) or less from the ground, the machine may be pushed off the truck or trailer.

FOR SAFETY: When unloading machine off truck or trailer, use winch. Do not push the machine off the truck or trailer unless the loading surface is horizontal AND 380 mm (15 in) or less from the ground.

MACHINE JACKING

Empty the recovery and solution tanks before jacking the machine. You can jack up the machine for service anywhere under the recovery tank. Use a hoist or jack that will support the weight of the machine. Use a piece of wood to distribute the machine weight load.

Always stop the machine on a flat level surface and block the machine tires before jacking up the machine.

FOR SAFETY: When servicing machine, block machine tires before jacking machine up.

FOR SAFETY: When servicing machine, jack machine up at designated locations only. Block machine up with jack stands.

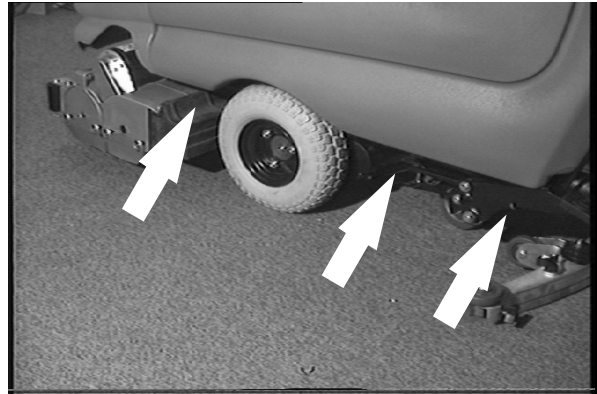

STORAGE INFORMATION

The following steps should be taken when storing the machine for extended periods of time.

1. Drain and clean the solution and recovery tanks.
2. Charge the batteries before storing machine to prolong the life of the batteries. Recharge batteries once a month.
3. Disconnect batteries before storing.
4. Park the machine in a cool, dry area.

FREEZE PROTECTION

1. Drain the solution tank and recovery tank of all water.
2. Pour 2 gallons (8 liters) of recreational vehicle (RV) antifreeze into the solution tank at full strength. Do not dilute.

FOR SAFETY: Avoid eye contact with antifreeze. Wear safety glasses.

3. Turn the machine power on and operate the solution flow system. Turn the machine off when the red RV antifreeze is visible.

If your machine is equipped with the off- aisle wand option, operate the off- aisle wand for a few seconds to protect the pump.

Continue with the freeze protection procedure if machine is equipped with the *ec- H2O* system.

ec-H2O NanoClean Models: **(ec-H2O models labeled ec-H2O NanoClean)**

Operate machine in the ec-H2O mode to cycle antifreeze through ec-H2O system.

After storing machine in freezing temperatures, drain any remaining antifreeze from the solution tank. Add clean water to solution tank and operate the machine to flush system.

ec-H2O Models: **(ec-H2O models manufactured before ec-H2O NanoClean models)**

4. Press and release the flush switch on the *ec-H2O* module to cycle the antifreeze through *ec-H2O* system. When the antifreeze is visible, press the switch again to turn off the module. The module is located behind the front cover.

IMPORTANT: Before operating machine, the antifreeze must be flushed from the module as described below.

If the antifreeze is not properly flushed from the *ec-H2O* system, the *ec-H2O* module may detect an error and not function (*ec-H2O* switch indicator light will turn red). If this occurs, reset key and repeat the flush procedure as described below.

Flushing antifreeze from ec-H2O module: **(ec-H2O models manufactured before ec-H2O NanoClean models)**

1. Drain the antifreeze from the solution tank into a bucket.
2. Fill the solution tank with cool water until full (See FILLING SOLUTION TANK).
3. Disconnect the black connector fitting at the scrub head and place the hose into a bucket. To access the connector fitting, you may have to remove the front cover from the machine.
4. Press and release the *ec-H2O* module flush switch to start the flush cycle. The module is located behind the front cover.

When the water turns clear, press the module switch again to stop the flush cycle.

Dispose the antifreeze in an environmentally safe way according to local waste disposal regulations.

5. The machine is now ready for scrubbing.

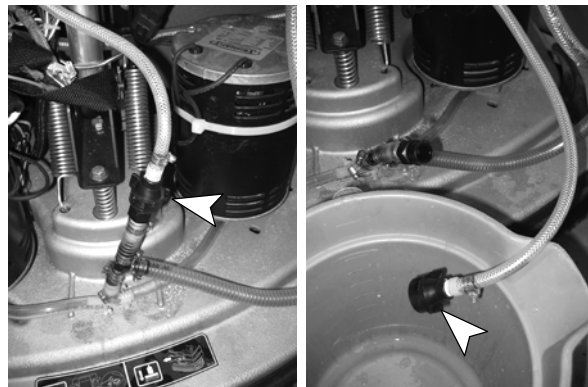
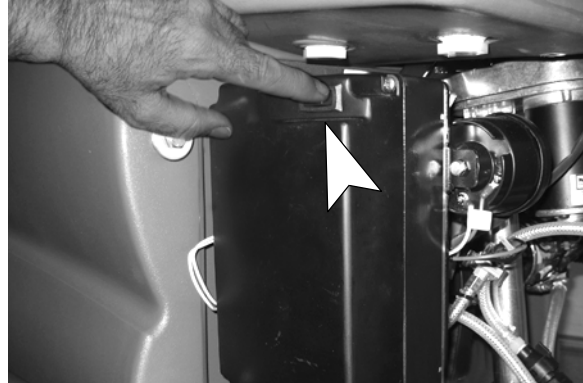

SPECIFICATIONS

GENERAL MACHINE DIMENSIONS/CAPACITIES

Item	Dimension/capacity
Length with cylindrical scrub head	1600 mm (63 in)
Length with 700 mm (28 in) disk scrub head	1625 mm (64 in)
Length with 800 mm (32 in) disk scrub head	1660 mm (65.25 in)
Length with 900 mm (36 in) disk scrub head	1690 mm (66.5 in)
Width (less squeegee and scrub head)	720 mm (28.25 in)
Height	1090 mm (43 in)
Disk brush diameter for 700 mm (28 in) scrub head	355 mm (14 in)
Disk brush diameter for 800 mm (32 in) scrub head	405 mm (16 in)
Disk brush diameter for 900 mm (36 in) scrub head	455 mm (18 in)
Cylindrical brush diameter	150 mm (6 in)
Cylindrical brush length for 700 mm (28 in) scrub head	700 mm (28.00 in)
Cylindrical brush length for 800 mm (32 in) scrub head	800 mm (32.00 in)
Cylindrical brush length for 900 mm (36 in) scrub head	900 mm (36.00 in)
Squeegee width for 700 mm (28 in) scrub head	950 mm (37.5 in)
Squeegee width for 800 mm (32 in) scrub head	1070 mm (42 in)
Squeegee width for 900 mm (36 in) scrub head	1160 mm (45.5 in)
Scrubbing path width for 700 mm (28 in) scrub head	700 mm (28 in)
Scrubbing path width for 800 mm (32 in) scrub head	800 mm (32 in)
Scrubbing path width for 900 mm (36 in) scrub head	900 mm (36 in)
Solution tank capacity (recommended usage)	114 L (30 gal)
Solution tank capacity (maximum)	133 L (35 gal)
Recovery tank capacity to full sensor	114 L (30 gal)
Recovery tank capacity to top of tank	152 L (40 gal)
Transaxle 90 weight gear lubricant capacity	1.42 L (1.5 qt)
GVWR	690 kg (1520 lb)

SPECIFICATIONS

FaST SYSTEM (OPTION)

Item	Measure
Solution pump	36 Volt DC, 5A, 5.7 LPM (1.5 GPM) open flow, 45 psi bypass setting
Solution flow rate	0.83 LPM (0.22 GPM)
Detergent pump	36 Volt DC
Concentrate flow rate	0.9 CC/Minute (0.03 Ounces/Minute)
Concentrate to water dilution ratio	1:1000

ec-H2O SYSTEM (OPTION)

Item	Measure
Solution pump	36 Volt DC, 5A, 5.7 LPM (1.5 GPM) open flow, 45 psi bypass setting
Solution flow rate* - Disk 700 mm (28 in)	0.22 gpm / 0.83 L/min (standard)
	0.33 gpm / 1.25 L/min (optional)
	0.44 gpm / 1.66 L/min (optional)
Solution flow rate* - Disk 800 mm (32 in)	0.22 gpm / 0.83 L/min (standard)
	0.33 gpm / 1.25 L/min (optional)
	0.44 gpm / 1.66 L/min (optional)
Solution flow rate* - Disk 900 mm (36 in)	0.30 gpm / 1.10 L/min (standard)
	0.44 gpm / 1.66 L/min (optional)
	0.53 gpm / 2.00 L/min (optional)
Solution flow rate* - Cylindrical 700 mm (28 in)	0.33 gpm / 1.25 L/min (standard)
	0.44 gpm / 1.66 L/min (optional)
Solution flow rate* - Cylindrical 800 mm (32 in)	0.33 gpm / 1.25 L/min (standard)
	0.44 gpm / 1.66 L/min (optional)
Solution flow rate* - Cylindrical 900 mm (36 in)	0.44 gpm / 1.66 L/min (standard)
	0.53 gpm / 2.00 LPM (optional)

* ec- H2O models manufactured before ec-H2O NanoClean models - If the optional solution flow rates are required, contact an Authorized Service Center.

GENERAL MACHINE PERFORMANCE

Item	Measure
Aisle turnaround width with 700 mm (28 in) scrub head	1680 mm (66.25 in)
Aisle turnaround width with 800 mm (32 in) scrub head	1700 mm (67 in)
Aisle turnaround width with 900 mm (36 in) scrub head	1725 mm (67.5 in)
Maximum rated climb and descent angle with empty tanks	8°
Maximum rated climb and descent angle with full tanks	6°

POWER TYPE

Type	Quantity	Volts	Ah Rating	Weight
Batteries	6	6	235 @ 20 hr rate	30 kg (67 lb)
	6	6	335 @ 20 hr rate	47 kg (104 lb)

Type	Use	VDC	Kw (hp)
Electric Motors	Scrub brush (disk)	36	0.45 (0.60)
	Heavy duty scrub brush (disk)	36	0.75 (1)
	Scrub brush (cylindrical)	36	0.56 (0.75)
	Vacuum fan	36	0.63 (0.85)
	Propelling	36	0.37 (0.50)

Type	VDC	amp	Hz	Phase	VAC
Chargers (Smart)	36	20	60	1	115
	36	30	60	1	115
Chargers (International)	36	20	50	1	230
	36	20	50	1	245
	36	30	50	1	230
	36	30	50	1	245

TIRES

Location	Type	Size	Pressure
Front (2)	Pneumatic	4.10/3.5 - 6	415 to 450 kPa (60 to 65 psi)
Front (2)	Solid (option)	1.2/3.0- 6	-
Rear, casters (2)	Solid, non-marking	5 x 2 in	-

SPECIFICATIONS

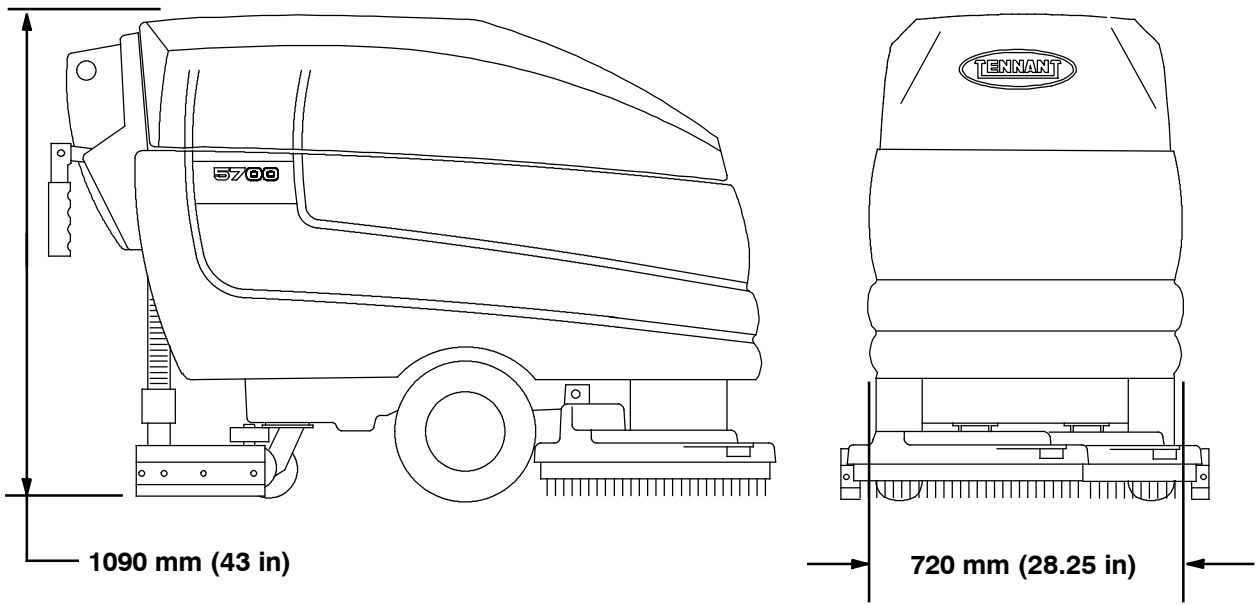
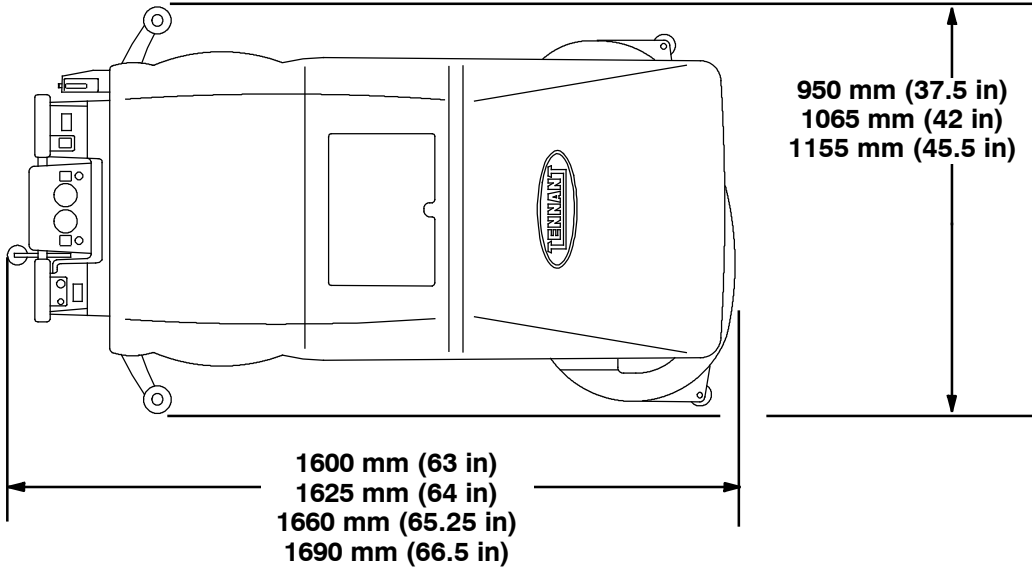

MACHINE DIMENSIONS

10189